

**IFB# GHURA-11-16-2021-AMP's 1, 3 & 4**

**Specification  
for the**

**Renovation of Eight (8) Public Housing Units  
at AMP's 1, 3 & 4**

**OWNER  
Guam Housing and Urban Renewal Authority**

**BY: \_\_\_\_\_  
Ray S. Topasna, EXECUTIVE DIRECTOR**

**Contractor: \_\_\_\_\_**

**By: \_\_\_\_\_**

**Signature and Title**

**Date: \_\_\_\_\_**

## Table of Contents

<b>IFB Number:</b> GHURA-11-16-2021-AMP's 1, 3 & 4		<b>Submit bid to:</b>  <b>GHURA</b> <b>117 Bien Venida Ave.</b> <b>Sinajana, Guam 96910</b>  Contact: Sonny Perez, 475-1404 or email <a href="mailto:sperez@ghura.org">sperez@ghura.org</a>  Andrew Manglona, 475-1315 or email <a href="mailto:amanglona@ghura.org">amanglona@ghura.org</a>
<b>Bid Opening Date:</b> Dec. 16 ,2021	<b>Bid Opening Time:</b> 2:00 pm	
<b>Project Title:</b> Renovation of (8) Eight Public Housing Units at AMPs 1, 3 & 4		
<b>Project Description:</b> Renovation of Existing Units		

<b>Section</b>	<b>Title</b>
<b>01</b>	Cover and Title Page
<b>02</b>	Table of Contents
<hr/>	
<b>Bidding Requirements</b>	
<b>03</b>	Invitation for bids
<b>04</b>	Instructions to Bidders / Offerors
<b>05</b>	Representations, Certifications, and Other Statements of Bidders– HUD Form 5369-a
<b>AG Forms</b>	
<b>06</b>	Affidavit Disclosing Ownership & Commission - AG Form 002
<b>06a</b>	Affidavit re Non-Collusion - AG Form 003
<b>06b</b>	Affidavit re No Gratuities or Kickbacks - AG Form 004
<b>06c</b>	Affidavit re Ethical Standards - AG Form 005
<b>06d</b>	Affidavit re Contingent Fees - AG Form 007
<b>07</b>	Non- Collusion Affidavit and Section 3 preference in contracting – GHURA Form – 008c
<b>08</b>	Law to be observed – GHURA Form 09
<b>09</b>	Bidder's Qualification – GHURA Form 010
<b>Contracting Requirements</b>	
<b>010</b>	Supplemental General Conditions – HUD Form 5370
<b>011</b>	Additional Supplemental Conditions - Mandatory Compliance for Section 3 - GHURA Form 0012
<b>012</b>	Wage Rates Transcript/ General Decision
<b>013</b>	Federal Labor Standards
<b>014</b>	Bid form – GHURA Form 014
<b>015</b>	Schedule of Amounts for Contract Payments – HUD Form 51000
<b>016</b>	Bid Bond – GHURA Form 016
<b>017</b>	Contractor's Reporting Requirements-Contractor License and Clearance
<b>018</b>	Form of Contract – GHURA Form 019
<b>019</b>	Insurances- see General Conditions
<b>Specification</b>	
<b>020</b>	Special Condition and Project Location
<b>021</b>	Project Manual and Specifications



# GHURA

Guahan Housing and Urban Renewal Authority  
Aturidat Ginima' Yan Rinueban Siudat Guahan  
117 Bien Venida Avenue, Sinajana, GU 96910  
Phone: (671) 477-9851 · Fax: (671) 300-7565 · TTY: (671) 472-3701



**Lourdes A. Leon Guerrero**  
Governor of Guam

**Joshua F. Tenorio**  
Lt. Governor of Guam

**Invitation for Bid**  
IFB # GHURA-11-16-2021-AMPs 1, 3 & 4  
**Renovation of Eight (8) Public Housing Units at AMPs 1, 3 & 4**  
This ad is paid with HUD Funds by GHURA

Guam Housing and Urban Renewal Authority (GHURA) will receive sealed proposals to renovate eight vacant Public Housing Units at AMP's 1, 3 & 4 located in Asan, Sinajana, Toto, Agat, Umatac and Merizo until **2:00 pm on December 16, 2021**, at GHURA's Main office in Sinajana.

GHURA has redesigned the bid process to comply with Executive Order 2020-14. GHURA maintains and enforces health and safety mitigation measures (i.e. social distancing, wearing of mask, frequent sanitization, occupancy limitation, etc.) which are outlined in the Guam DPHSS guidelines. An instructional video outlining the new bid process, the bid packet and bid forms are available on our website at:

<https://www.ghura.org/doing-business-us/bidsproposalsrelease-funds/invitation-bids>

Bids will be accepted until **December 16, 2021 by 2:00 PM** at GHURA's Main Office in Sinajana. To be deemed official, a non-refundable bid packet fee of \$50.00 (exact cash amount, money order, or company check) is required and can be submitted prior to or upon submission of a bid. A pre-bid conference will be held on **November 23, 2021 at 10:00 AM** in the **GHURA Main Office Conference Room** in Sinajana. Any questions regarding the project or requirements must be submitted in writing or via email to Greta Balmeo at [gbalmeo@ghura.org](mailto:gbalmeo@ghura.org) no later than **December 9, 2021**. Bid closing date and time is **December 16, 2021, 2:00 PM**. All bid submittals will be opened publicly at **GHURA's Main Office Conference Room, Sinajana**.

Pursuant to 5GCA, Chapter 5, §5212, bid guarantees in the amount of 15% of the total base bid shall accompany each bid. Bid guarantee shall be a Bid Bond secured by a surety company authorized to do business in Guam and listed in the latest Department of Treasury Circular 570 published in the Federal Register; or as permitted by state law, a certified check, bank draft, or U.S. Government Bond at par value. All Bid Guarantees must be made payable to GHURA. **Personal checks will not be accepted**. GHURA reserves the right to waive irregularities and to reject any or all bids. Failure to submit a bid properly shall result in rejection of the bid.

For all contracts which exceed \$100,000, the successful bidder will be required to furnish and pay for satisfactory Performance and Payment bond for 100% of the contract price. GHURA will retain the bid guarantee until the performance bond is received and will release it soon thereafter. The Contractor must not discriminate on the basis of race, color, religion, sex, national origin, age, disability, or genetic information in employment or the provision of services. Restriction Against Contractors Employing Convicted Sex Offenders from Working at Government of Guam Venues. (§5253 of Title 5 Guam Code Annotated).

The successful bidder will be required to accomplish the following to the best possible and greatest extent feasible:

1. A goal of awarding at least 50 percent of the dollar value of construction contracts to Minority and/or Women Business Enterprises (MBE/WBE) or General Contractors with MBE/WBE participation.
2. In accordance with Section 3 of the U.S. Department of Housing and Urban Development Act of 1968, all construction contractors, to the maximum extent feasible, shall provide training, contracting, and employment opportunities to low income residents residing in GHURA.

GHURA intends to award a contract on the basis of the lowest and most responsible bid for the work described in the bid documents. No bid shall be withdrawn for a period of sixty (60) days subsequent to the opening of bids without the prior written consent of GHURA.

GHURA is an Equal Opportunity Employer.

  
Ray S. Topasna  
Executive Director

**U.S. Department of Housing and  
Urban Development**  
Office of Public and Indian Housing

**Instructions to Bidders for Contracts  
Public and Indian Housing Programs**

# Instructions to Bidders for Contracts

## Public and Indian Housing Programs

### Table of Contents

Clause	Page
1. Bid Preparation and Submission	1
2. Explanations and Interpretations to Prospective Bidders	1
3. Amendments to Invitations for Bids	1
4. Responsibility of Prospective Contractor	1
5. Late Submissions, Modifications, and Withdrawal of Bids	1
6. Bid Opening	2
7. Service of Protest	2
8. Contract Award	2
9. Bid Guarantee	3
10. Assurance of Completion	3
11. Preconstruction Conference	3
12. Indian Preference Requirements	3

### 1. Bid Preparation and Submission

(a) Bidders are expected to examine the specifications, drawings, all instructions, and, if applicable, the construction site (see also the contract clause entitled **Site Investigation and Conditions Affecting the Work** of the *General Conditions of the Contract for Construction*). Failure to do so will be at the bidders' risk.

(b) All bids must be submitted on the forms provided by the Public Housing Agency/Indian Housing Authority (PHA/IHA). Bidders shall furnish all the information required by the solicitation. Bids must be signed and the bidder's name typed or printed on the bid sheet and each continuation sheet which requires the entry of information by the bidder. Erasures or other changes must be initialed by the person signing the bid. Bids signed by an agent shall be accompanied by evidence of that agent's authority. (Bidders should retain a copy of their bid for their records.)

(c) Bidders must submit as part of their bid a completed form HUD-5369-A, "Representations, Certifications, and Other Statements of Bidders."

(d) All bid documents shall be sealed in an envelope which shall be clearly marked with the words "Bid Documents," the Invitation for Bids (IFB) number, any project or other identifying number, the bidder's name, and the date and time for receipt of bids.

(e) If this solicitation requires bidding on all items, failure to do so will disqualify the bid. If bidding on all items is not required, bidders should insert the words "No Bid" in the space provided for any item on which no price is submitted.

(f) Unless expressly authorized elsewhere in this solicitation, alternate bids will not be considered.

(g) Unless expressly authorized elsewhere in this solicitation, bids submitted by telegraph or facsimile (fax) machines will not be considered.

(h) If the proposed contract is for a Mutual Help project (as described in 24 CFR Part 905, Subpart E) that involves Mutual Help contributions of work, material, or equipment, supplemental information regarding the bid advertisement is provided as an attachment to this solicitation.

### 2. Explanations and Interpretations to Prospective Bidders

(a) Any prospective bidder desiring an explanation or interpretation of the solicitation, specifications, drawings, etc., must request it at least 7 days before the scheduled time for bid opening. Requests may be oral or written. Oral requests must be confirmed in writing. The only oral clarifications that will be provided will be those clearly related to solicitation procedures, i.e., not substantive technical information. No other oral explanation or interpretation will be provided. Any information given a prospective bidder concerning this solicitation will be furnished promptly to all other prospective bidders as a written amendment to the solicitation, if that information is necessary in submitting bids, or if the lack of it would be prejudicial to other prospective bidders.

(b) Any information obtained by, or provided to, a bidder other than by formal amendment to the solicitation shall not constitute a change to the solicitation.

### 3. Amendments to Invitations for Bids

(a) If this solicitation is amended, then all terms and conditions which are not modified remain unchanged.

(b) Bidders shall acknowledge receipt of any amendment to this solicitation (1) by signing and returning the amendment, (2) by identifying the amendment number and date on the bid form, or (3) by letter, telegram, or facsimile, if those methods are authorized in the solicitation. The PHA/IHA must receive acknowledgement by the time and at the place specified for receipt of bids. Bids which fail to acknowledge the bidder's receipt of any amendment will result in the rejection of the bid if the amendment(s) contained information which substantively changed the PHA's/IHA's requirements.

(c) Amendments will be on file in the offices of the PHA/IHA and the Architect at least 7 days before bid opening.

### 4. Responsibility of Prospective Contractor

(a) The PHA/IHA will award contracts only to responsible prospective contractors who have the ability to perform successfully under the terms and conditions of the proposed contract. In determining the responsibility of a bidder, the PHA/IHA will consider such matters as the bidder's:

- (1) Integrity;
- (2) Compliance with public policy;
- (3) Record of past performance; and
- (4) Financial and technical resources (including construction and technical equipment).

(b) Before a bid is considered for award, the bidder may be requested by the PHA/IHA to submit a statement or other documentation regarding any of the items in paragraph (a) above. Failure by the bidder to provide such additional information shall render the bidder nonresponsible and ineligible for award.

## 5. Late Submissions, Modifications, and Withdrawal of Bids

(a) Any bid received at the place designated in the solicitation after the exact time specified for receipt will not be considered unless it is received before award is made and it:

(1) Was sent by registered or certified mail not later than the fifth calendar day before the date specified for receipt of offers (e.g., an offer submitted in response to a solicitation requiring receipt of offers by the 20th of the month must have been mailed by the 15th);

(2) Was sent by mail, or if authorized by the solicitation, was sent by telegram or via facsimile, and it is determined by the PHA/IHA that the late receipt was due solely to mishandling by the PHA/IHA after receipt at the PHA/IHA; or

(3) Was sent by U.S. Postal Service Express Mail Next Day Service - Post Office to Addressee, not later than 5:00 p.m. at the place of mailing two working days prior to the date specified for receipt of proposals. The term "working days" excludes weekends and observed holidays.

(b) Any modification or withdrawal of a bid is subject to the same conditions as in paragraph (a) of this provision.

(c) The only acceptable evidence to establish the date of mailing of a late bid, modification, or withdrawal sent either by registered or certified mail is the U.S. or Canadian Postal Service postmark both on the envelope or wrapper and on the original receipt from the U.S. or Canadian Postal Service. Both postmarks must show a legible date or the bid, modification, or withdrawal shall be processed as if mailed late. "Postmark" means a printed, stamped, or otherwise placed impression (exclusive of a postage meter machine impression) that is readily identifiable without further action as having been supplied and affixed by employees of the U.S. or Canadian Postal Service on the date of mailing. Therefore, bidders should request the postal clerk to place a hand cancellation bull's-eye postmark on both the receipt and the envelope or wrapper.

(d) The only acceptable evidence to establish the time of receipt at the PHA/IHA is the time/date stamp of PHA/IHA on the proposal wrapper or other documentary evidence of receipt maintained by the PHA/IHA.

(e) The only acceptable evidence to establish the date of mailing of a late bid, modification, or withdrawal sent by Express Mail Next Day Service-Post Office to Addressee is the date entered by the post office receiving clerk on the "Express Mail Next Day Service-Post Office to Addressee" label and the postmark on both the envelope or wrapper and on the original receipt from the U.S. Postal Service. "Postmark" has the same meaning as defined in paragraph (c) of this provision, excluding postmarks of the Canadian Postal Service. Therefore, bidders should request the postal clerk to place a legible hand cancellation bull's eye postmark on both the receipt and Failure by a bidder to acknowledge receipt of the envelope or wrapper.

(f) Notwithstanding paragraph (a) of this provision, a late modification of an otherwise successful bid that makes its terms more favorable to the PHA/IHA will be considered at any time it is received and may be accepted.

(g) Bids may be withdrawn by written notice, or if authorized by this solicitation, by telegram (including mailgram) or facsimile machine transmission received at any time before the exact time set for opening of bids; provided that written confirmation of telegraphic or facsimile withdrawals over the signature of the bidder is mailed and postmarked prior to the specified bid opening time. A bid may be withdrawn in person by a bidder or its authorized representative if, before the exact time set for opening of bids, the identity of the person requesting withdrawal is established and the person signs a receipt for the bid.

## 6. Bid Opening

All bids received by the date and time of receipt specified in the solicitation will be publicly opened and read. The time and place of opening will be as specified in the solicitation. Bidders and other interested persons may be present.

## 7. Service of Protest

(a) Definitions. As used in this provision:

"Interested party" means an actual or prospective bidder whose direct economic interest would be affected by the award of the contract.

"Protest" means a written objection by an interested party to this solicitation or to a proposed or actual award of a contract pursuant to this solicitation.

(b) Protests shall be served on the Contracting Officer by obtaining written and dated acknowledgement from —

[Contracting Officer designate the official or location where a protest may be served on the Contracting Officer]

(c) All protests shall be resolved in accordance with the PHA's/IHA's protest policy and procedures, copies of which are maintained at the PHA/IHA.

## 8. Contract Award

(a) The PHA/IHA will evaluate bids in response to this solicitation without discussions and will award a contract to the responsible bidder whose bid, conforming to the solicitation, will be most advantageous to the PHA/IHA considering only price and any price-related factors specified in the solicitation.

(b) If the apparent low bid received in response to this solicitation exceeds the PHA's/IHA's available funding for the proposed contract work, the PHA/IHA may either accept separately priced items (see 8(e) below) or use the following procedure to determine contract award. The PHA/IHA shall apply in turn to each bid (proceeding in order from the apparent low bid to the high bid) each of the separately priced bid deductible items, if any, in their priority order set forth in this solicitation. If upon the application of the first deductible item to all initial bids, a new low bid is within the PHA's/IHA's available funding, then award shall be made to that bidder. If no bid is within the available funding amount, then the PHA/IHA shall apply the second deductible item. The PHA/IHA shall continue this process until an evaluated low bid, if any, is within the PHA's/IHA's available funding. If upon the application of all deductibles, no bid is within the PHA's/IHA's available funding, or if the solicitation does not request separately priced deductibles, the PHA/IHA shall follow its written policy and procedures in making any award under this solicitation.

(c) In the case of tie low bids, award shall be made in accordance with the PHA's/IHA's written policy and procedures.

(d) The PHA/IHA may reject any and all bids, except other than the lowest bid (e.g., the apparent low bid is unreasonably low), and waive informalities or minor irregularities in bids received, in accordance with the PHA's/IHA's written policy and procedures.

(e) Unless precluded elsewhere in the solicitation, the PHA/IHA may accept any item or combination of items bid.

(f) The PHA/IHA may reject any bid as nonresponsive if it is materially unbalanced as to the prices for the various items of work to be performed. A bid is materially unbalanced when it is based on prices significantly less than cost for some work and prices which are significantly overstated for other work.

(g) A written award shall be furnished to the successful bidder within the period for acceptance specified in the bid and shall result in a binding contract without further action by either party.

**9. Bid Guarantee (applicable to construction and equipment contracts exceeding \$25,000)**

All bids must be accompanied by a negotiable bid guarantee which shall not be less than five percent (5%) of the amount of the bid. The bid guarantee may be a certified check, bank draft, U.S. Government Bonds at par value, or a bid bond secured by a surety company acceptable to the U.S. Government and authorized to do business in the state where the work is to be performed. In the case where the work under the contract will be performed on an Indian reservation area, the bid guarantee may also be an irrevocable Letter of Credit (see provision 10, Assurance of Completion, below). Certified checks and bank drafts must be made payable to the order of the PHA/IHA. The bid guarantee shall insure the execution of the contract and the furnishing of a method of assurance of completion by the successful bidder as required by the solicitation. Failure to submit a bid guarantee with the bid shall result in the rejection of the bid. Bid guarantees submitted by unsuccessful bidders will be returned as soon as practicable after bid opening.

**10. Assurance of Completion**

(a) Unless otherwise provided in State law, the successful bidder shall furnish an assurance of completion prior to the execution of any contract under this solicitation. This assurance may be [Contracting Officer check applicable items] —

[ ] (1) a performance and payment bond in a penal sum of 100 percent of the contract price; or, as may be required or permitted by State law;

[ ] (2) separate performance and payment bonds, each for 50 percent or more of the contract price;

[ ] (3) a 20 percent cash escrow;

[ ] (4) a 25 percent irrevocable letter of credit; or,

[ ] (5) an irrevocable letter of credit for 10 percent of the total contract price with a monitoring and disbursements agreement with the IHA (applicable only to contracts awarded by an IHA under the Indian Housing Program).

(b) Bonds must be obtained from guarantee or surety companies acceptable to the U.S. Government and authorized to do business in the state where the work is to be performed. Individual sureties will not be considered. U.S. Treasury Circular Number 570, published annually in the Federal Register, lists companies approved to act as sureties on bonds securing Government contracts, the maximum underwriting limits on each contract bonded, and the States in which the company is licensed to do business. Use of companies listed in this circular is mandatory. Copies of the circular may be downloaded on the U.S. Department of Treasury website <http://www.fms.treas.gov/c570/index.html>, or ordered for a minimum fee by contacting the Government Printing Office at (202) 512-2168.

(c) Each bond shall clearly state the rate of premium and the total amount of premium charged. The current power of attorney for the person who signs for the surety company must be attached to the bond. The effective date of the power of attorney shall not precede the date of the bond. The effective date of the bond shall be on or after the execution date of the contract.

(d) Failure by the successful bidder to obtain the required assurance of completion within the time specified, or within such extended period as the PHA/IHA may grant based upon reasons determined adequate by the PHA/IHA, shall render the bidder ineligible for award. The PHA/IHA may then either award the contract to the next lowest responsible bidder or solicit new bids. The PHA/IHA may retain the ineligible bidder's bid guarantee.

**11. Preconstruction Conference (applicable to construction contracts)**

After award of a contract under this solicitation and prior to the start of work, the successful bidder will be required to attend a preconstruction conference with representatives of the PHA/IHA and its architect/engineer, and other interested parties convened by the PHA/IHA. The conference will serve to acquaint the participants with the general plan of the construction operation and all other requirements of the contract (e.g., Equal Employment Opportunity, Labor Standards). The PHA/IHA will provide the successful bidder with the date, time, and place of the conference.

**12. Indian Preference Requirements (applicable only if this solicitation is for a contract to be performed on a project for an Indian Housing Authority)**

(a) HUD has determined that the contract awarded under this solicitation is subject to the requirements of section 7(b) of the Indian Self-Determination and Education Assistance Act (25 U.S.C. 450e(b)). Section 7(b) requires that any contract or subcontract entered into for the benefit of Indians shall require that, to the greatest extent feasible

(1) Preferences and opportunities for training and employment (other than core crew positions; see paragraph (h) below) in connection with the administration of such contracts or subcontracts be given to qualified "Indians." The Act defines "Indians" to mean persons who are members of an Indian tribe and defines "Indian tribe" to mean any Indian tribe, band, nation, or other organized group or community, including any Alaska Native village or regional or village corporation as defined in or established pursuant to the Alaska Native Claims Settlement Act, which is recognized as eligible for the special programs and services provided by the United States to Indians because of their status as Indians; and,

(2) Preference in the award of contracts or subcontracts in connection with the administration of contracts be given to Indian organizations and to Indian-owned economic enterprises, as defined in section 3 of the Indian Financing Act of 1974 (25 U.S.C. 1452). That Act defines "economic enterprise" to mean any Indian-owned commercial, industrial, or business activity established or organized for the purpose of profit, except that the Indian ownership must constitute not less than 51 percent of the enterprise; "Indian organization" to mean the governing body of any Indian tribe or entity established or recognized by such governing body; "Indian" to mean any person who is a member of any tribe, band, group, pueblo, or community which is recognized by the Federal Government as eligible for services from the Bureau of Indian Affairs and any "Native" as defined in the Alaska Native Claims Settlement Act; and Indian "tribe" to mean any Indian tribe, band, group, pueblo, or community including Native villages and Native groups (including

corporations organized by Kenai, Juneau, Sitka, and Kodiak) as defined in the Alaska Native Claims Settlement Act, which is recognized by the Federal Government as eligible for services from the Bureau of Indian Affairs.

(b) (1) The successful Contractor under this solicitation shall comply with the requirements of this provision in awarding all subcontracts under the contract and in providing training and employment opportunities.

(2) A finding by the IHA that the contractor, either (i) awarded a subcontract without using the procedure required by the IHA, (ii) falsely represented that subcontracts would be awarded to Indian enterprises or organizations; or, (iii) failed to comply with the contractor's employment and training preference bid statement shall be grounds for termination of the contract or for the assessment of penalties or other remedies.

(c) If specified elsewhere in this solicitation, the IHA may restrict the solicitation to qualified Indian-owned enterprises and Indian organizations. If two or more (or a greater number as specified elsewhere in the solicitation) qualified Indian-owned enterprises or organizations submit responsive bids, award shall be made to the qualified enterprise or organization with the lowest responsive bid. If fewer than the minimum required number of qualified Indian-owned enterprises or organizations submit responsive bids, the IHA shall reject all bids and readvertise the solicitation in accordance with paragraph (d) below.

(d) If the IHA prefers not to restrict the solicitation as described in paragraph (c) above, or if after having restricted a solicitation an insufficient number of qualified Indian enterprises or organizations submit bids, the IHA may advertise for bids from non-Indian as well as Indian-owned enterprises and Indian organizations. Award shall be made to the qualified Indian enterprise or organization with the lowest responsive bid if that bid is -

(1) Within the maximum HUD-approved budget amount established for the specific project or activity for which bids are being solicited; and

(2) No more than the percentage specified in 24 CFR 905.175(c) higher than the total bid price of the lowest responsive bid from any qualified bidder. If no responsive bid by a qualified Indian-owned economic enterprise or organization is within the stated range of the total bid price of the lowest responsive bid from any qualified enterprise, award shall be made to the bidder with the lowest bid.

(e) Bidders seeking to qualify for preference in contracting or subcontracting shall submit proof of Indian ownership with their bids. Proof of Indian ownership shall include but not be limited to:

(1) Certification by a tribe or other evidence that the bidder is an Indian. The IHA shall accept the certification of a tribe that an individual is a member.

(2) Evidence such as stock ownership, structure, management, control, financing and salary or profit sharing arrangements of the enterprise.

(f) (1) All bidders must submit with their bids a statement describing how they will provide Indian preference in the award of subcontracts. The specific requirements of that statement and the factors to be used by the IHA in determining the statement's adequacy are included as an attachment to this solicitation. Any bid that fails to include the required statement shall be rejected as nonresponsive. The IHA may require that comparable statements be provided by subcontractors to the successful Contractor, and may require the Contractor to reject any bid or proposal by a subcontractor that fails to include the statement.

(2) Bidders and prospective subcontractors shall submit a certification (supported by credible evidence) to the IHA in any instance where the bidder or subcontractor believes it is infeasible to provide Indian preference in subcontracting. The acceptance or rejection by the IHA of the certification shall be final. Rejection shall disqualify the bid from further consideration.

(g) All bidders must submit with their bids a statement detailing their employment and training opportunities and their plans to provide preference to Indians in implementing the contract; and the number or percentage of Indians anticipated to be employed and trained. Comparable statements from all proposed subcontractors must be submitted. The criteria to be used by the IHA in determining the statement(s)'s adequacy are included as an attachment to this solicitation. Any bid that fails to include the required statement(s), or that includes a statement that does not meet minimum standards required by the IHA shall be rejected as nonresponsive.

(h) Core crew employees. A core crew employee is an individual who is a bona fide employee of the contractor at the time the bid is submitted; or an individual who was not employed by the bidder at the time the bid was submitted, but who is regularly employed by the bidder in a supervisory or other key skilled position when work is available. Bidders shall submit with their bids a list of all core crew employees.

(i) Preference in contracting, subcontracting, employment, and training shall apply not only on-site, on the reservation, or within the IHA's jurisdiction, but also to contracts with firms that operate outside these areas (e.g., employment in modular or manufactured housing construction facilities).

(j) Bidders should contact the IHA to determine if any additional local preference requirements are applicable to this solicitation.

(k) The IHA [ ] does [ ] does not [Contracting Officer check applicable box] maintain lists of Indian-owned economic enterprises and Indian organizations by specialty (e.g., plumbing, electrical, foundations), which are available to bidders to assist them in meeting their responsibility to provide preference in connection with the administration of contracts and subcontracts.



**U.S. Department of Housing  
and Urban Development**  
Office of Public and Indian Housing

**Representations, Certifications,  
and Other Statements of Bidders**  
**Public and Indian Housing Programs**

# Representations, Certifications, and Other Statements of Bidders

## Public and Indian Housing Programs

### Table of Contents

Clause	Page
1. Certificate of Independent Price Determination	1
2. Contingent Fee Representation and Agreement	1
3. Certification and Disclosure Regarding Payments to Influence Certain Federal Transactions	1
4. Organizational Conflicts of Interest Certification	2
5. Bidder's Certification of Eligibility	2
6. Minimum Bid Acceptance Period	2
7. Small, Minority, Women-Owned Business Concern Representation	2
8. Indian-Owned Economic Enterprise and Indian Organization Representation	2
9. Certification of Eligibility Under the Davis-Bacon Act	3
10. Certification of Nonsegregated Facilities	3
11. Clean Air and Water Certification	3
12. Previous Participation Certificate	3
13. Bidder's Signature	3

### 1. Certificate of Independent Price Determination

(a) The bidder certifies that--

(1) The prices in this bid have been arrived at independently, without, for the purpose of restricting competition, any consultation, communication, or agreement with any other bidder or competitor relating to (i) those prices, (ii) the intention to submit a bid, or (iii) the methods or factors used to calculate the prices offered;

(2) The prices in this bid have not been and will not be knowingly disclosed by the bidder, directly or indirectly, to any other bidder or competitor before bid opening (in the case of a sealed bid solicitation) or contract award (in the case of a competitive proposal solicitation) unless otherwise required by law; and

(3) No attempt has been made or will be made by the bidder to induce any other concern to submit or not to submit a bid for the purpose of restricting competition.

(b) Each signature on the bid is considered to be a certification by the signatory that the signatory--

(1) Is the person in the bidder's organization responsible for determining the prices being offered in this bid or proposal, and that the signatory has not participated and will not participate in any action contrary to subparagraphs (a)(1) through (a)(3) above; or

(2) (i) Has been authorized, in writing, to act as agent for the following principals in certifying that those principals have not participated, and will not participate in any action contrary to subparagraphs (a)(1) through (a)(3) above.

\_\_\_\_\_ [insert full name of person(s) in the bidder's organization responsible for determining the prices offered in this bid or proposal, and the title of his or her position in the bidder's organization];

(ii) As an authorized agent, does certify that the principals named in subdivision (b)(2)(i) above have not participated, and will not participate, in any action contrary to subparagraphs (a)(1) through (a)(3) above; and

(iii) As an agent, has not personally participated, and will not participate in any action contrary to subparagraphs (a)(1) through (a)(3) above.

(c) If the bidder deletes or modifies subparagraph (a)2 above, the bidder must furnish with its bid a signed statement setting forth in detail the circumstances of the disclosure.

[ ] [Contracting Officer check if following paragraph is applicable]

(d) Non-collusive affidavit. (applicable to contracts for construction and equipment exceeding \$50,000)

(1) Each bidder shall execute, in the form provided by the PHA/IHA, an affidavit to the effect that he/she has not colluded with any other person, firm or corporation in regard to any bid submitted in response to this solicitation. If the successful bidder did not submit the affidavit with his/her bid, he/she must submit it within three (3) working days of bid opening. Failure to submit the affidavit by that date may render the bid nonresponsive. No contract award will be made without a properly executed affidavit.

(2) A fully executed "Non-collusive Affidavit" [ ] is, [ ] is not included with the bid.

### 2. Contingent Fee Representation and Agreement

(a) Definitions. As used in this provision:

"Bona fide employee" means a person, employed by a bidder and subject to the bidder's supervision and control as to time, place, and manner of performance, who neither exerts, nor proposes to exert improper influence to solicit or obtain contracts nor holds out as being able to obtain any contract(s) through improper influence.

"Improper influence" means any influence that induces or tends to induce a PHA/IHA employee or officer to give consideration or to act regarding a PHA/IHA contract on any basis other than the merits of the matter.

(b) The bidder represents and certifies as part of its bid that, except for full-time bona fide employees working solely for the bidder, the bidder:

(1) [ ] has, [ ] has not employed or retained any person or company to solicit or obtain this contract; and

(2) [ ] has, [ ] has not paid or agreed to pay to any person or company employed or retained to solicit or obtain this contract any commission, percentage, brokerage, or other fee contingent upon or resulting from the award of this contract.

(c) If the answer to either (a)(1) or (a)(2) above is affirmative, the bidder shall make an immediate and full written disclosure to the PHA/IHA Contracting Officer.

(d) Any misrepresentation by the bidder shall give the PHA/IHA the right to (1) terminate the contract; (2) at its discretion, deduct from contract payments the amount of any commission, percentage, brokerage, or other contingent fee; or (3) take other remedy pursuant to the contract.

### 3. Certification and Disclosure Regarding Payments to Influence Certain Federal Transactions (applicable to contracts exceeding \$100,000)

(a) The definitions and prohibitions contained in Section 1352 of title 31, United States Code, are hereby incorporated by reference in paragraph (b) of this certification.

(b) The bidder, by signing its bid, hereby certifies to the best of his or her knowledge and belief as of December 23, 1989 that:

(1) No Federal appropriated funds have been paid or will be paid to any person for influencing or attempting to influence an officer or employee of any agency, a Member of Congress, an officer or employee of Congress, or an employee of a Member of Congress on his or her behalf in connection with the awarding of a contract resulting from this solicitation;

(2) If any funds other than Federal appropriated funds (including profit or fee received under a covered Federal transaction) have been paid, or will be paid, to any person for influencing or attempting to influence an officer or employee of any agency, a Member of Congress, an officer or employee of Congress, or an employee of a Member of Congress on his or her behalf in connection with this solicitation, the bidder shall complete and submit, with its bid, OMB standard form LLL, "Disclosure of Lobbying Activities;" and

(3) He or she will include the language of this certification in all subcontracts at any tier and require that all recipients of subcontract awards in excess of \$100,000 shall certify and disclose accordingly.

(c) Submission of this certification and disclosure is a prerequisite for making or entering into this contract imposed by section 1352, title 31, United States Code. Any person who makes an expenditure prohibited under this provision or who fails to file or amend the disclosure form to be filed or amended by this provision, shall be subject to a civil penalty of not less than \$10,000, and not more than \$100,000, for each such failure.

(d) Indian tribes (except those chartered by States) and Indian organizations as defined in section 4 of the Indian Self-Determination and Education Assistance Act (25 U.S.C. 450B) are exempt from the requirements of this provision.

#### 4. Organizational Conflicts of Interest Certification

The bidder certifies that to the best of its knowledge and belief and except as otherwise disclosed, he or she does not have any organizational conflict of interest which is defined as a situation in which the nature of work to be performed under this proposed contract and the bidder's organizational, financial, contractual, or other interests may, without some restriction on future activities:

- (a) Result in an unfair competitive advantage to the bidder; or,
- (b) Impair the bidder's objectivity in performing the contract work.

[ ] In the absence of any actual or apparent conflict, I hereby certify that to the best of my knowledge and belief, no actual or apparent conflict of interest exists with regard to my possible performance of this procurement.

#### 5. Bidder's Certification of Eligibility

(a) By the submission of this bid, the bidder certifies that to the best of its knowledge and belief, neither it, nor any person or firm which has an interest in the bidder's firm, nor any of the bidder's subcontractors, is ineligible to:

(1) Be awarded contracts by any agency of the United States Government, HUD, or the State in which this contract is to be performed; or,

(2) Participate in HUD programs pursuant to 24 CFR Part 24.

(b) The certification in paragraph (a) above is a material representation of fact upon which reliance was placed when making award. If it is later determined that the bidder knowingly rendered an erroneous certification, the contract may be terminated for default, and the bidder may be debarred or suspended from participation in HUD programs and other Federal contract programs.

#### 6. Minimum Bid Acceptance Period

(a) "Acceptance period," as used in this provision, means the number of calendar days available to the PHA/IHA for awarding a contract from the date specified in this solicitation for receipt of bids.

(b) This provision supersedes any language pertaining to the acceptance period that may appear elsewhere in this solicitation.

(c) The PHA/IHA requires a minimum acceptance period of [Contracting Officer insert time period] calendar days.

(d) In the space provided immediately below, bidders may specify a longer acceptance period than the PHA's/IHA's minimum requirement. The bidder allows the following acceptance period: calendar days.

(e) A bid allowing less than the PHA's/IHA's minimum acceptance period will be rejected.

(f) The bidder agrees to execute all that it has undertaken to do, in compliance with its bid, if that bid is accepted in writing within (1) the acceptance period stated in paragraph (c) above or (2) any longer acceptance period stated in paragraph (d) above.

#### 7. Small, Minority, Women-Owned Business Concern Representation

The bidder represents and certifies as part of its bid/ offer that it --

(a) [ ] is, [ ] is not a small business concern. "Small business concern," as used in this provision, means a concern, including its affiliates, that is independently owned and operated, not dominant in the field of operation in which it is bidding, and qualified as a small business under the criteria and size standards in 13 CFR 121.

(b) [ ] is, [ ] is not a women-owned business enterprise. "Women-owned business enterprise," as used in this provision, means a business that is at least 51 percent owned by a woman or women who are U.S. citizens and who also control and operate the business.

(c) [ ] is, [ ] is not a minority business enterprise. "Minority business enterprise," as used in this provision, means a business which is at least 51 percent owned or controlled by one or more minority group members or, in the case of a publicly owned business, at least 51 percent of its voting stock is owned by one or more minority group members, and whose management and daily operations are controlled by one or more such individuals. For the purpose of this definition, minority group members are:

(Check the block applicable to you)

- [ ] Black Americans
- [ ] Asian Pacific Americans
- [ ] Hispanic Americans
- [ ] Asian Indian Americans
- [ ] Native Americans
- [ ] Hasidic Jewish Americans

#### 8. Indian-Owned Economic Enterprise and Indian Organization Representation (applicable only if this solicitation is for a contract to be performed on a project for an Indian Housing Authority)

The bidder represents and certifies that it:

(a) [ ] is, [ ] is not an Indian-owned economic enterprise. "Economic enterprise," as used in this provision, means any commercial, industrial, or business activity established or organized for the purpose of profit, which is at least 51 percent Indian owned. "Indian," as used in this provision, means any person who is a member of any tribe, band, group, pueblo, or community which is recognized by the Federal Government as eligible for services from the Bureau of Indian Affairs and any "Native" as defined in the Alaska Native Claims Settlement Act.

(b) [ ] is, [ ] is not an Indian organization. "Indian organization," as used in this provision, means the governing body of any Indian tribe or entity established or recognized by such governing body. Indian "tribe" means any Indian tribe, band, group, pueblo, or

community including Native villages and Native groups (including corporations organized by Kenai, Juneau, Sitka, and Kodiak) as defined in the Alaska Native Claims Settlement Act, which is recognized by the Federal Government as eligible for services from the Bureau of Indian Affairs.

**9. Certification of Eligibility Under the Davis-Bacon Act** (applicable to construction contracts exceeding \$2,000)

(a) By the submission of this bid, the bidder certifies that neither it nor any person or firm who has an interest in the bidder's firm is a person or firm ineligible to be awarded contracts by the United States Government by virtue of section 3(a) of the Davis-Bacon Act or 29 CFR 5.12(a)(1).

(b) No part of the contract resulting from this solicitation shall be subcontracted to any person or firm ineligible to be awarded contracts by the United States Government by virtue of section 3(a) of the Davis-Bacon Act or 29 CFR 5.12(a)(1).

(c) The penalty for making false statements is prescribed in the U. S. Criminal Code, 18 U.S.C. 1001.

**10. Certification of Nonsegregated Facilities** (applicable to contracts exceeding \$10,000)

(a) The bidder's attention is called to the clause entitled **Equal Employment Opportunity** of the General Conditions of the Contract for Construction.

(b) "Segregated facilities," as used in this provision, means any waiting rooms, work areas, rest rooms and wash rooms, restaurants and other eating areas, time clocks, locker rooms and other storage or dressing areas, parking lots, drinking fountains, recreation or entertainment areas, transportation, and housing facilities provided for employees, that are segregated by explicit directive or are in fact segregated on the basis of race, color, religion, or national origin because of habit, local custom, or otherwise.

(c) By the submission of this bid, the bidder certifies that it does not and will not maintain or provide for its employees any segregated facilities at any of its establishments, and that it does not and will not permit its employees to perform their services at any location under its control where segregated facilities are maintained. The bidder agrees that a breach of this certification is a violation of the Equal Employment Opportunity clause in the contract.

(d) The bidder further agrees that (except where it has obtained identical certifications from proposed subcontractors for specific time periods) prior to entering into subcontracts which exceed \$10,000 and are not exempt from the requirements of the Equal Employment Opportunity clause, it will:

- (1) Obtain identical certifications from the proposed subcontractors;
- (2) Retain the certifications in its files; and
- (3) Forward the following notice to the proposed subcontractors (except if the proposed subcontractors have submitted identical certifications for specific time periods):

**Notice to Prospective Subcontractors of Requirement for Certifications of Nonsegregated Facilities**

A Certification of Nonsegregated Facilities must be submitted before the award of a subcontract exceeding \$10,000 which is not exempt from the provisions of the Equal Employment Opportunity clause of the prime contract. The certification may be submitted either for each subcontract or for all subcontracts during a period (i.e., quarterly, semiannually, or annually).

**Note:** The penalty for making false statements in bids is prescribed in 18 U.S.C. 1001.

**11. Clean Air and Water Certification** (applicable to contracts exceeding \$100,000)

The bidder certifies that:

(a) Any facility to be used in the performance of this contract [ ] is, [ ] is not listed on the Environmental Protection Agency List of Violating Facilities:

(b) The bidder will immediately notify the PHA/IHA Contracting Officer, before award, of the receipt of any communication from the Administrator, or a designee, of the Environmental Protection Agency, indicating that any facility that the bidder proposes to use for the performance of the contract is under consideration to be listed on the EPA List of Violating Facilities; and,

(c) The bidder will include a certification substantially the same as this certification, including this paragraph (c), in every nonexempt subcontract.

**12. Previous Participation Certificate** (applicable to construction and equipment contracts exceeding \$50,000)

(a) The bidder shall complete and submit with his/her bid the Form HUD-2530, "Previous Participation Certificate." If the successful bidder does not submit the certificate with his/her bid, he/she must submit it within three (3) working days of bid opening. Failure to submit the certificate by that date may render the bid nonresponsive. No contract award will be made without a properly executed certificate.

(b) A fully executed "Previous Participation Certificate" [ ] is, [ ] is not included with the bid.

**13. Bidder's Signature**

The bidder hereby certifies that the information contained in these certifications and representations is accurate, complete, and current.

\_\_\_\_\_  
(Signature and Date)

\_\_\_\_\_  
(Typed or Printed Name)

\_\_\_\_\_  
(Title)

\_\_\_\_\_  
(Company Name)

\_\_\_\_\_  
(Company Address)













**Certification for Business Concerns Seeking Section 3 Preference in Contracting and Demonstration of Capability**

Name of business \_\_\_\_\_  
Address of business \_\_\_\_\_

Type of Business  Corporation  Partnership  
 Sole Proprietorship  Joint Venture

Attached is the following documentation as evidence of status:

For business claiming status as a Section 3 resident-owned Enterprise:

- Copy of resident lease
- Copy of evidence of participation in a public assistance program
- Other evidence

For the business entity as applicable:

- Copy of Articles of Incorporation
- Assumed Business Name Certificate
- List of owners/stockholder and % of each
- Organization chart with names and titles and brief functional statement
- Certificate of Good Standing
- Partnership Agreement
- Corporation Annual Report
- Latest Board minutes appointing officers
- Additional documentation

For business claiming Section 3 status by subcontracting 25 percent of the dollar awarded to qualified Section 3 business

- List of subcontracted Section 3 business with corresponding certifications and subcontract amount

For business claiming Section 3 status, claiming at least 30 percent of their workforce are currently Section 3 residents or were Section 3 eligible residents within 3 years of date of first employment with the business

- List of all current full time employees
- PHA/IHA Residential lease (less than 3 years from day of employment)
- List of all employees claiming Section 3 status
- Other evidence of Section 3 status (less than 3 years from date of employment)

Evidence of ability to perform successfully under the terms and conditions of the proposed contract:

- Current financial statement
- Statement ability to comply with public policy
- List of owned equipment
- List of all contracts for the past two years

\_\_\_\_\_

Corporate Seal

\_\_\_\_\_  
Authorizing Name and Signature

Attested By \_\_\_\_\_

Name \_\_\_\_\_

**Law to be Observed**

1. The Proposer is to be familiar with federal and local laws, codes, ordinances, and regulations which, in any manner, affect those engaged or employed in the work or the material or equipment used in or upon the site, or in any way affect the conduct of the work. No place of misunderstanding or ignorance on the part of the Arbitrator will in any way serve to modify the provision of the contract.

2. Restriction Against Contractors Employing Convicted Sex Offenders from Working at Government of Guam Venues. (§5253 of Title 5 Guam Code Annotated).

(a) No person convicted of a sex offense under the provisions of Chapter 25 of Title 9 Guam Code Annotated, or an offense as defined in Article 2 of Chapter 28, Title 9 GCA in Guam, or an offense in any jurisdiction which includes, at a minimum all of the elements of said offenses, or who is listed on the Sex Offender Registry, and who is employed by a business contracted to perform services for an agency or instrumentality of the Government of Guam other than a public highway;

By submission of this bid or offer, each Vendor and each person signing on behalf of any Vendor certifies, and in the case of a joint bids or offers each party thereto certifies as to its own organization, under penalty of perjury, that to the best of his knowledge and belief will be in compliance:

\_\_\_\_\_  
Print Name:

\_\_\_\_\_  
Print Name:

\_\_\_\_\_  
Signature:

\_\_\_\_\_  
Signature:

Title: \_\_\_\_\_  
Bidder/offeror, if the Bidder/offeror is an Individual  
Partner, if the Bidder/offeror is a Partnership  
Officer, if the Bidder/offeror is a Corporation

Title: \_\_\_\_\_  
Bidder/offeror, if the Bidder/offeror is an Individual  
Partner, if the Bidder/offeror is a Partnership  
Officer, if the Bidder/offeror is a Corporation

Company Name: \_\_\_\_\_

Company Name: \_\_\_\_\_

Date: \_\_\_\_\_

Date: \_\_\_\_\_

## Bidder's Qualifications

All questions must be answered and the data given must be clear and comprehensive. This statement must be notarized. If necessary add separate sheets for items requiring additional explanation. This information may be submitted in a separate sealed envelope marked "Bidder's Qualifications and Financial Statement". In the event your bid is not selected for award, this envelope will be returned to the Contractor unopened.

1. Name of Bidder	2. Date organized
3. Permanent main office address	4. State incorporated
	5. How many years have you been engaged in the contracting business under your present firm name?

6. Listing of current contracts: (Schedule these, showing nature of the work, gross amount of each contract, anticipated dates for completion, name and telephone number of owner's representative).

7. General character of work usually performed by your company.

8. Have you ever failed to complete any work awarded to you? If so, where and why?

9. Have you ever defaulted on a contract?

10. List the three (3) most important structures recently completed by your company, stating approximate cost of each, month and year completed, name and telephone number of owner's representative.

11. List your major equipment available for use on this contract.

12. Experience in construction work similar in importance to this project.



13. Background and experience of the principal members of your firm, including the officers and proposed construction superintendent.

--

14. Credit available for administration of this contract, furnish written evidence.

--

15. Financial report not more than three (3) months old and containing a balance sheet providing at least the following information.

**Balance Sheet**

**ASSETS**

**CURRENT ASSETS:**

- Cash
- Joint Venture Accounts
- Accounts Receivable
- Notes Receivable
- Accrued Interest on Notes
- Deposits
- Material and Prepaid Expense
- Total Current Assets

**FIXED ASSETS - NET**

**OTHER ASSETS**

**TOTAL ASSETS:**

**LIABILITIES AND CAPITAL**

**CURRENT LIABILITIES**

- Accounts Payable
- Notes Payable
- Accrued Interest on Notes
- Provision for Income Taxes
- Advances Received from Owners
- Accrued Salaries
- Accrued Payroll Taxes
- Other
- Total Current Liabilities

**OTHER LIABILITIES**

**CAPITAL**

- Capital Stock
- Authorized and Outstanding Shares,  
Par Value
- Earned Surplus

**TOTAL LIABILITIES AND CAPITAL**

The undersigned hereby authorizes and requests any person, firm, or corporation to furnish any information requested by the Guam Housing and Urban Renewal Authority in verification of the recitals comprising this Statement of Bidder's Qualifications.

Signature of Bidder	Name of Bidder
Date	Title of Bidder

Sworn to before me this \_\_\_\_ day of \_\_\_\_\_, 20 \_\_\_\_

\_\_\_\_\_  
Notary Public  
My Commission Expires \_\_\_\_\_

# General Conditions for Construction Contracts - Public Housing Programs

U.S. Department of Housing and Urban Development  
Office of Public and Indian Housing  
OMB Approval No. 2577-0157 (exp. 3/31/2020)

**Applicability. This form is applicable to any construction/development contract greater than \$150,000.**

This form includes those clauses required by OMB's common rule on grantee procurement, implemented at HUD in 2 CFR 200, and those requirements set forth in Section 3 of the Housing and Urban Development Act of 1968 and its amendment by the Housing and Community Development Act of 1992, implemented by HUD at 24 CFR Part 135. The form is required for construction contracts awarded by Public Housing Agencies (PHAs).

The form is used by Housing Authorities in solicitations to provide necessary contract clauses. If the form were not used, HAs would be unable to enforce their contracts.

Public reporting burden for this collection of information is estimated to average 1.0 hours per response, including the time for reviewing instructions, searching existing data sources, gathering and maintaining the data needed, and completing and reviewing the collection of information. Responses to the collection of information are required to obtain a benefit or to retain a benefit.

The information requested does not lend itself to confidentiality.

HUD may not conduct or sponsor, and a person is not required to respond to a collection of information unless it displays a currently valid OMB number.

## Table of Contents

Clause		Page	Clause		Page
1.	Definitions	2	<b>Administrative Requirements</b>		
2.	Contractor's Responsibility for Work	2	25.	Contract Period	9
3.	Architect's Duties, Responsibilities and Authority	2	26.	Order of Precedence	9
4.	Other Contracts	3	27.	Payments	9
<b>Construction Requirements</b>			28.	Contract Modifications	10
5.	Preconstruction Conference and Notice to Proceed	3	29.	Changes	10
6.	Construction Progress Schedule	3	30.	Suspension of Work	11
7.	Site Investigation and Conditions Affecting the Work	3	31.	Disputes	11
8.	Differing Site Conditions	4	32.	Default	11
9.	Specifications and Drawings for Construction	4	33.	Liquidated	12
10.	As-Built Drawings	5	34.	Termination of Convenience	12
11.	Material and Workmanship	5	35.	Assignment of Contract	12
12.	Permits and Codes	5	36.	Insurance	12
13.	Health, Safety, and Accident Prevention	6	37.	Subcontracts	13
14	Temporary Buildings and Transportation Materials	6	38	Subcontracting with Small and Minority Firms, Women's Business Enterprise, and Labor Surplus Area Firms	13
15.	Availability and Use of Utility Services	6	39.	Equal Employment Opportunity	13
16	Protection of Existing Vegetation, Structures, Equipment, Utilities, and Improvements	6	40	Employment, Training, and Contracting Opportunities for Low-Income Persons, Section 3 of the Housing and Urban Development Act of 1968	14
17.	Temporary Buildings and Transportation Materials	7	41.	Interest of Members of Congress	15
18	Clean Air and Water	7	42	Interest of Members, Officers, or Employees and Former Members, Officers, or Employees	15
19.	Energy Efficiency	7	43.	Limitations on Payments Made to Influence	15
20.	Inspection and Acceptance of Construction	7	44.	Royalties and Patents	15
21.	Use and Possession Prior to	8	45.	Examination and Retention of Contractor's Records	15
22.	Warranty of Title	8	46.	Labor Standards-Davis-Bacon and Related Acts	15
23.	Warranty of	8	47.	Non-Federal Prevailing Wage Rates	19
24.	Prohibition Against Liens	9	48.	Procurement of Recovered	19

---

## 1. Definitions

- (a) "Architect" means the person or other entity engaged by the PHA to perform architectural, engineering, design, and other services related to the work as provided for in the contract. When a PHA uses an engineer to act in this capacity, the terms "architect" and "engineer" shall be synonymous. The Architect shall serve as a technical representative of the Contracting Officer. The Architect's authority is as set forth elsewhere in this contract.
  - (b) "Contract" means the contract entered into between the PHA and the Contractor. It includes the forms of Bid, the Bid Bond, the Performance and Payment Bond or Bonds or other assurance of completion, the Certifications, Representations, and Other Statements of Bidders (form HUD-5370), these General Conditions of the Contract for Construction (form HUD-5370), the applicable wage rate determinations from the U.S. Department of Labor, any special conditions included elsewhere in the contract, the specifications, and drawings. It includes all formal changes to any of those documents by addendum, change order, or other modification.
  - (c) "Contracting Officer" means the person delegated the authority by the PHA to enter into, administer, and/or terminate this contract and designated as such in writing to the Contractor. The term includes any successor Contracting Officer and any duly authorized representative of the Contracting Officer also designated in writing. The Contracting Officer shall be deemed the authorized agent of the PHA in all dealings with the Contractor.
  - (d) "Contractor" means the person or other entity entering into the contract with the PHA to perform all of the work required under the contract.
  - (e) "Drawings" means the drawings enumerated in the schedule of drawings contained in the Specifications and as described in the contract clause entitled Specifications and Drawings for Construction herein.
  - (f) "HUD" means the United States of America acting through the Department of Housing and Urban Development including the Secretary, or any other person designated to act on its behalf. HUD has agreed, subject to the provisions of an Annual Contributions Contract (ACC), to provide financial assistance to the PHA, which includes assistance in financing the work to be performed under this contract. As defined elsewhere in these General Conditions or the contract documents, the determination of HUD may be required to authorize changes in the work or for release of funds to the PHA for payment to the Contractor. Notwithstanding HUD's role, nothing in this contract shall be construed to create any contractual relationship between the Contractor and HUD.
  - (g) "Project" means the entire project, whether construction or rehabilitation, the work for which is provided for in whole or in part under this contract.
  - (h) "PHA" means the Public Housing Agency organized under applicable state laws which is a party to this contract.
  - (j) "Specifications" means the written description of the technical requirements for construction and includes the criteria and tests for determining whether the requirements are met.
  - (l) "Work" means materials, workmanship, and manufacture and fabrication of components.
- (a) The Contractor shall furnish all necessary labor, materials, tools, equipment, and transportation necessary for performance of the work. The Contractor shall also furnish all necessary water, heat, light, and power not made available to the Contractor by the PHA pursuant to the clause entitled Availability and Use of Utility Services herein.
  - (b) The Contractor shall perform on the site, and with its own organization, work equivalent to at least [ ] (12 percent unless otherwise indicated) of the total amount of work to be performed under the order. This percentage may be reduced by a supplemental agreement to this order if, during performing the work, the Contractor requests a reduction and the Contracting Officer determines that the reduction would be to the advantage of the PHA.
  - (c) At all times during performance of this contract and until the work is completed and accepted, the Contractor shall directly superintend the work or assign and have on the work site a competent superintendent who is satisfactory to the Contracting Officer and has authority to act for the Contractor.
  - (d) The Contractor shall be responsible for all damages to persons or property that occur as a result of the Contractor's fault or negligence, and shall take proper safety and health precautions to protect the work, the workers, the public, and the property of others. The Contractor shall hold and save the PHA, its officers and agents, free and harmless from liability of any nature occasioned by the Contractor's performance. The Contractor shall also be responsible for all materials delivered and work performed until completion and acceptance of the entire work, except for any completed unit of work which may have been accepted under the contract.
  - (e) The Contractor shall lay out the work from base lines and bench marks indicated on the drawings and be responsible for all lines, levels, and measurements of all work executed under the contract. The Contractor shall verify the figures before laying out the work and will be held responsible for any error resulting from its failure to do so.
  - (f) The Contractor shall confine all operations (including storage of materials) on PHA premises to areas authorized or approved by the Contracting Officer.
  - (g) The Contractor shall at all times keep the work area, including storage areas, free from accumulations of waste materials. After completing the work and before final inspection, the Contractor shall (1) remove from the premises all scaffolding, equipment, tools, and materials (including rejected materials) that are not the property of the PHA and all rubbish caused by its work; (2) leave the work area in a clean, neat, and orderly condition satisfactory to the Contracting Officer; (3) perform all specified tests; and, (4) deliver the installation in complete and operating condition.
  - (h) The Contractor's responsibility will terminate when all work has been completed, the final inspection made, and the work accepted by the Contracting Officer. The Contractor will then be released from further obligation except as required by the warranties specified elsewhere in the contract.

## 3. Architect's Duties, Responsibilities, and Authority

- (a) The Architect for this contract, and any successor, shall be designated in writing by the Contracting Officer.

## 2. Contractor's Responsibility for Work



- 
- (b) The Architect shall serve as the Contracting Officer's technical representative with respect to architectural, engineering, and design matters related to the work performed under the contract. The Architect may provide direction on contract performance. Such direction shall be within the scope of the contract and may not be of a nature which: (1) institutes additional work outside the scope of the contract; (2) constitutes a change as defined in the Changes clause herein; (3) causes an increase or decrease in the cost of the contract; (4) alters the Construction Progress Schedule; or (5) changes any of the other express terms or conditions of the contract.
- (c) The Architect's duties and responsibilities may include but shall not be limited to:
- (1) Making periodic visits to the work site, and on the basis of his/her on-site inspections, issuing written reports to the PHA which shall include all observed deficiencies. The Architect shall file a copy of the report with the Contractor's designated representative at the site;
  - (2) Making modifications in drawings and technical specifications and assisting the Contracting Officer in the preparation of change orders and other contract modifications for issuance by the Contracting Officer;
  - (3) Reviewing and making recommendations with respect to - (i) the Contractor's construction progress schedules; (ii) the Contractor's shop and detailed drawings; (iii) the machinery, mechanical and other equipment and materials or other articles proposed for use by the Contractor; and, (iv) the Contractor's price breakdown and progress payment estimates; and,
  - (4) Assisting in inspections, signing Certificates of Completion, and making recommendations with respect to acceptance of work completed under the contract.

#### 4. Other Contracts

The PHA may undertake or award other contracts for additional work at or near the site of the work under this contract. The Contractor shall fully cooperate with the other contractors and with PHA employees and shall carefully adapt scheduling and performing the work under this contract to accommodate the additional work, heeding any direction that may be provided by the Contracting Officer. The Contractor shall not commit or permit any act that will interfere with the performance of work by any other contractor or by PHA employees

### Construction Requirements

#### 5. Pre-construction Conference and Notice to Proceed

- (a) Within ten calendar days of contract execution, and prior to the commencement of work, the Contractor shall attend a preconstruction conference with representatives of the PHA, its Architect, and other interested parties convened by the PHA. The conference will serve to acquaint the participants with the general plan of the construction operation and all other requirements of the contract. The PHA will provide the Contractor with the date, time, and place of the conference.
- (b) The contractor shall begin work upon receipt of a written Notice to Proceed from the Contracting Officer or designee. The Contractor shall not begin work prior to receiving such notice.

#### 6. Construction Progress Schedule

- (a) The Contractor shall, within five days after the work commences on the contract or another period of time determined by the Contracting Officer, prepare and submit to the Contracting Officer for approval three copies of a practicable schedule showing the order in which the Contractor proposes to perform the work, and the dates on which the Contractor contemplates starting and completing the several salient features of the work (including acquiring labor, materials, and equipment). The schedule shall be in the form of a progress chart of suitable scale to indicate appropriately the percentage of work scheduled for completion by any given date during the period. If the Contractor fails to submit a schedule within the time prescribed, the Contracting Officer may withhold approval of progress payments or take other remedies under the contract until the Contractor submits the required schedule.
- (b) The Contractor shall enter the actual progress on the chart as required by the Contracting Officer, and immediately deliver three copies of the annotated schedule to the Contracting Officer. If the Contracting Officer determines, upon the basis of inspection conducted pursuant to the clause entitled Inspection and Acceptance of Construction, herein that the Contractor is not meeting the approved schedule, the Contractor shall take steps necessary to improve its progress, including those that may be required by the Contracting Officer, without additional cost to the PHA. In this circumstance, the Contracting Officer may require the Contractor to increase the number of shifts, overtime operations, days of work, and/or the amount of construction plant, and to submit for approval any supplementary schedule or schedules in chart form as the Contracting Officer deems necessary to demonstrate how the approved rate of progress will be regained.
- (c) Failure of the Contractor to comply with the requirements of the Contracting Officer under this clause shall be grounds for a determination by the Contracting Officer that the Contractor is not prosecuting the work with sufficient diligence to ensure completion within the time specified in the Contract. Upon making this determination, the Contracting Officer may terminate the Contractor's right to proceed with the work, or any separable part of it, in accordance with the Default clause of this contract.

#### 7. Site Investigation and Conditions Affecting the Work

- (a) The Contractor acknowledges that it has taken steps reasonably necessary to ascertain the nature and location of the work, and that it has investigated and satisfied itself as to the general and local conditions which can affect the work or its cost, including but not limited to, (1) conditions bearing upon transportation, disposal, handling, and storage of materials; (2) the availability of labor, water, electric power, and roads; (3) uncertainties of weather, river stages, tides, or similar physical conditions at the site; (4) the conformation and conditions of the ground; and (5) the character of equipment and facilities needed preliminary to and during work performance. The Contractor also acknowledges that it has satisfied itself as to the character, quality, and quantity of surface and subsurface materials or obstacles to be encountered insofar as this information is

---

reasonably ascertainable from an inspection of the site, including all exploratory work done by the PHA, as well as from the drawings and specifications made a part of this contract. Any failure of the Contractor to take the actions described and acknowledged in this paragraph will not relieve the Contractor from responsibility for estimating properly the difficulty and cost of successfully performing the work, or for proceeding to successfully perform the work without additional expense to the PHA.

- (b) The PHA assumes no responsibility for any conclusions or interpretations made by the Contractor based on the information made available by the PHA. Nor does the PHA assume responsibility for any understanding reached or representation made concerning conditions which can affect the work by any of its officers or agents before the execution of this contract, unless that understanding or representation is expressly stated in this contract.

### 8. Differing Site Conditions

- (a) The Contractor shall promptly, and before the conditions are disturbed, give a written notice to the Contracting Officer of (1) subsurface or latent physical conditions at the site which differ materially from those indicated in this contract, or (2) unknown physical conditions at the site(s), of an unusual nature, which differ materially from those ordinarily encountered and generally recognized as inhering in work of the character provided for in the contract.
- (b) The Contracting Officer shall investigate the site conditions promptly after receiving the notice. Work shall not proceed at the affected site, except at the Contractor's risk, until the Contracting Officer has provided written instructions to the Contractor. If the conditions do materially so differ and cause an increase or decrease in the Contractor's cost of, or the time required for, performing any part of the work under this contract, whether or not changed as a result of the conditions, the Contractor shall file a claim in writing to the PHA within ten days after receipt of such instructions and, in any event, before proceeding with the work. An equitable adjustment in the contract price, the delivery schedule, or both shall be made under this clause and the contract modified in writing accordingly.
- (c) No request by the Contractor for an equitable adjustment to the contract under this clause shall be allowed, unless the Contractor has given the written notice required; provided, that the time prescribed in (a) above for giving written notice may be extended by the Contracting Officer.
- (d) No request by the Contractor for an equitable adjustment to the contract for differing site conditions shall be allowed if made after final payment under this contract.

### 9. Specifications and Drawings for Construction

- (a) The Contractor shall keep on the work site a copy of the drawings and specifications and shall at all times give the Contracting Officer access thereto. Anything mentioned in the specifications and not shown on the drawings, or shown on the drawings and not mentioned in the specifications, shall be of like effect as if shown or mentioned in both. In case of difference between drawings and specifications, the specifications shall govern. In case of discrepancy in the figures, in the drawings, or in the specifications, the matter shall be

promptly submitted to the Contracting Officer, who shall promptly make a determination in writing. Any adjustment by the Contractor without such a determination shall be at its own risk and expense. The Contracting Officer shall furnish from time to time such detailed drawings and other information as considered necessary, unless otherwise provided.

- (b) Wherever in the specifications or upon the drawings the words "directed", "required", "ordered", "designated", "prescribed", or words of like import are used, it shall be understood that the "direction", "requirement", "order", "designation", or "prescription", of the Contracting Officer is intended and similarly the words "approved", "acceptable", "satisfactory", or words of like import shall mean "approved by", or "acceptable to", or "satisfactory to" the Contracting Officer, unless otherwise expressly stated.
- (c) Where "as shown" "as indicated", "as detailed", or of similar import are used, it shall be understood that the reference is made to the drawings accompanying this contract unless stated otherwise. The word "provided" as used herein shall be understood to mean "provide complete in place" that is "furnished and installed".
- (d) "Shop drawings" means drawings, submitted to the PHA by the Contractor, subcontractor, or any lower tier subcontractor, showing in detail (1) the proposed fabrication and assembly of structural elements and (2) the installation (i.e., form, fit, and attachment details) of materials of equipment. It includes drawings, diagrams, layouts, schematics, descriptive literature, illustrations, schedules, performance and test data, and similar materials furnished by the Contractor to explain in detail specific portions of the work required by the contract. The PHA may duplicate, use, and disclose in any manner and for any purpose shop drawings delivered under this contract.
- (e) If this contract requires shop drawings, the Contractor shall coordinate all such drawings, and review them for accuracy, completeness, and compliance with other contract requirements and shall indicate its approval thereon as evidence of such coordination and review. Shop drawings submitted to the Contracting Officer without evidence of the Contractor's approval may be returned for resubmission. The Contracting Officer will indicate an approval or disapproval of the shop drawings and if not approved as submitted shall indicate the PHA's reasons therefore. Any work done before such approval shall be at the Contractor's risk. Approval by the Contracting Officer shall not relieve the Contractor from responsibility for any errors or omissions in such drawings, nor from responsibility for complying with the requirements of this contract, except with respect to variations described and approved in accordance with (f) below.
- (f) If shop drawings show variations from the contract requirements, the Contractor shall describe such variations in writing, separate from the drawings, at the time of submission. If the Architect approves any such variation and the Contracting Officer concurs, the Contracting Officer shall issue an appropriate modification to the contract, except that, if the variation is minor or does not involve a change in price or in time of performance, a modification need not be issued.
- (g) It shall be the responsibility of the Contractor to make timely requests of the PHA for such large scale and full size drawings, color schemes, and other additional information, not already in his possession, which shall be

---

required in the planning and production of the work. Such requests may be submitted as the need arises, but each such request shall be filed in ample time to permit appropriate action to be taken by all parties involved so as to avoid delay.

- (h) The Contractor shall submit to the Contracting Officer for approval four copies (unless otherwise indicated) of all shop drawings as called for under the various headings of these specifications. Three sets (unless otherwise indicated) of all shop drawings, will be retained by the PHA and one set will be returned to the Contractor. As required by the Contracting Officer, the Contractor, upon completing the work under this contract, shall furnish a complete set of all shop drawings as finally approved. These drawings shall show all changes and revisions made up to the time the work is completed and accepted.
- (i) This clause shall be included in all subcontracts at any tier. It shall be the responsibility of the Contractor to ensure that all shop drawings prepared by subcontractors are submitted to the Contracting Officer.

#### 10. As-Built Drawings

- (a) "As-built drawings," as used in this clause, means drawings submitted by the Contractor or subcontractor at any tier to show the construction of a particular structure or work as actually completed under the contract. "As-built drawings" shall be synonymous with "Record drawings."
- (b) As required by the Contracting Officer, the Contractor shall provide the Contracting Officer accurate information to be used in the preparation of permanent as-built drawings. For this purpose, the Contractor shall record on one set of contract drawings all changes from the installations originally indicated, and record final locations of underground lines by depth from finish grade and by accurate horizontal offset distances to permanent surface improvements such as buildings, curbs, or edges of walks.
- (c) This clause shall be included in all subcontracts at any tier. It shall be the responsibility of the Contractor to ensure that all as-built drawings prepared by subcontractors are submitted to the Contracting Officer.

#### 11. Material and Workmanship

- (a) All equipment, material, and articles furnished under this contract shall be new and of the most suitable grade for the purpose intended, unless otherwise specifically provided in this contract. References in the contract to equipment, material, articles, or patented processes by trade name, make, or catalog number, shall be regarded as establishing a standard of quality and shall not be construed as limiting competition. The Contractor may, at its option, use any equipment, material, article, or process that, in the judgment of, and as approved by the Contracting Officer, is equal to that named in the specifications, unless otherwise specifically provided in this contract.
- (b) Approval of equipment and materials.
  - (1) The Contractor shall obtain the Contracting Officer's approval of the machinery and mechanical and other equipment to be incorporated into the work. When requesting approval, the Contractor shall furnish to the Contracting Officer the name of the manufacturer, the model number, and other information concerning the performance, capacity, nature, and rating of the

machinery and mechanical and other equipment. When required by this contract or by the Contracting Officer, the Contractor shall also obtain the Contracting Officer's approval of the material or articles which the Contractor contemplates incorporating into the work. When requesting approval, the Contractor shall provide full information concerning the material or articles. Machinery, equipment, material, and articles that do not have the required approval shall be installed or used at the risk of subsequent rejection.

- (2) When required by the specifications or the Contracting Officer, the Contractor shall submit appropriately marked samples (and certificates related to them) for approval at the Contractor's expense, with all shipping charges prepaid. The Contractor shall label, or otherwise properly mark on the container, the material or product represented, its place of origin, the name of the producer, the Contractor's name, and the identification of the construction project for which the material or product is intended to be used.
- (3) Certificates shall be submitted in triplicate, describing each sample submitted for approval and certifying that the material, equipment or accessory complies with contract requirements. The certificates shall include the name and brand of the product, name of manufacturer, and the location where produced.
- (4) Approval of a sample shall not constitute a waiver of the PHA right to demand full compliance with contract requirements. Materials, equipment and accessories may be rejected for cause even though samples have been approved.
- (5) Wherever materials are required to comply with recognized standards or specifications, such specifications shall be accepted as establishing the technical qualities and testing methods, but shall not govern the number of tests required to be made nor modify other contract requirements. The Contracting Officer may require laboratory test reports on items submitted for approval or may approve materials on the basis of data submitted in certificates with samples. Check tests will be made on materials delivered for use only as frequently as the Contracting Officer determines necessary to insure compliance of materials with the specifications. The Contractor will assume all costs of retesting materials which fail to meet contract requirements and/or testing materials offered in substitution for those found deficient.
- (6) After approval, samples will be kept in the Project office until completion of work. They may be built into the work after a substantial quantity of the materials they represent has been built in and accepted.
- (c) Requirements concerning lead-based paint. The Contractor shall comply with the requirements concerning lead-based paint contained in the Lead-Based Paint Poisoning Prevention Act (42 U.S.C. 4821-4846) as implemented by 24 CFR Part 35.

#### 12. Permits and Codes

- (a) The Contractor shall give all notices and comply with all applicable laws, ordinances, codes, rules and regulations. Notwithstanding the requirement of the Contractor to comply with the drawings and specifications in the contract, all work installed shall comply with all applicable codes and regulations as amended by any

---

waivers. Before installing the work, the Contractor shall examine the drawings and the specifications for compliance with applicable codes and regulations bearing on the work and shall immediately report any discrepancy it may discover to the Contracting Officer. Where the requirements of the drawings and specifications fail to comply with the applicable code or regulation, the Contracting Officer shall modify the contract by change order pursuant to the clause entitled Changes herein to conform to the code or regulation.

- (b) The Contractor shall secure and pay for all permits, fees, and licenses necessary for the proper execution and completion of the work. Where the PHA can arrange for the issuance of all or part of these permits, fees and licenses, without cost to the Contractor, the contract amount shall be reduced accordingly.

### 13. Health, Safety, and Accident Prevention

- (a) In performing this contract, the Contractor shall:
- (1) Ensure that no laborer or mechanic shall be required to work in surroundings or under working conditions which are unsanitary, hazardous, or dangerous to his/her health and/or safety as determined under construction safety and health standards promulgated by the Secretary of Labor by regulation;
  - (2) Protect the lives, health, and safety of other persons;
  - (3) Prevent damage to property, materials, supplies, and equipment; and,
  - (4) Avoid work interruptions.
- (b) For these purposes, the Contractor shall:
- (1) Comply with regulations and standards issued by the Secretary of Labor at 29 CFR Part 1926. Failure to comply may result in imposition of sanctions pursuant to the Contract Work Hours and Safety Standards Act (Public Law 91-54, 83 Stat. 96), 40 U.S.C. 3701 et seq.; and
  - (2) Include the terms of this clause in every subcontract so that such terms will be binding on each subcontractor.
- (c) The Contractor shall maintain an accurate record of exposure data on all accidents incident to work performed under this contract resulting in death, traumatic injury, occupational disease, or damage to property, materials, supplies, or equipment, and shall report this data in the manner prescribed by 29 CFR Part 1904.
- (d) The Contracting Officer shall notify the Contractor of any noncompliance with these requirements and of the corrective action required. This notice, when delivered to the Contractor or the Contractor's representative at the site of the work, shall be deemed sufficient notice of the noncompliance and corrective action required. After receiving the notice, the Contractor shall immediately take corrective action. If the Contractor fails or refuses to take corrective action promptly, the Contracting Officer may issue an order stopping all or part of the work until satisfactory corrective action has been taken. The Contractor shall not base any claim or request for equitable adjustment for additional time or money on any stop order issued under these circumstances.
- (e) The Contractor shall be responsible for its subcontractors' compliance with the provisions of this clause. The Contractor shall take such action with respect to any subcontract as the PHA, the Secretary of Housing and Urban Development, or the Secretary of Labor shall direct as a means of enforcing such provisions.

### 14. Temporary Heating

The Contractor shall provide and pay for temporary heating, covering, and enclosures necessary to properly protect all work and materials against damage by dampness and cold, to dry out the work, and to facilitate the completion of the work. Any permanent heating equipment used shall be turned over to the PHA in the condition and at the time required by the specifications.

### 15. Availability and Use of Utility Services

- (a) The PHA shall make all reasonably required amounts of utilities available to the Contractor from existing outlets and supplies, as specified in the contract. Unless otherwise provided in the contract, the amount of each utility service consumed shall be charged to or paid for by the Contractor at prevailing rates charged to the PHA or, where the utility is produced by the PHA, at reasonable rates determined by the Contracting Officer. The Contractor shall carefully conserve any utilities furnished without charge.
- (b) The Contractor, at its expense and in a manner satisfactory to the Contracting Officer, shall install and maintain all necessary temporary connections and distribution lines, and all meters required to measure the amount of each utility used for the purpose of determining charges. Before final acceptance of the work by the PHA, the Contractor shall remove all the temporary connections, distribution lines, meters, and associated paraphernalia.

### 16. Protection of Existing Vegetation, Structures, Equipment, Utilities, and Improvements

- (a) The Contractor shall preserve and protect all structures, equipment, and vegetation (such as trees, shrubs, and grass) on or adjacent to the work site, which are not to be removed under this contract, and which do not unreasonably interfere with the work required under this contract.
- (b) The Contractor shall only remove trees when specifically authorized to do so, and shall avoid damaging vegetation that will remain in place. If any limbs or branches of trees are broken during performance of this contract, or by the careless operation of equipment, or by workmen, the Contractor shall trim those limbs or branches with a clean cut and paint the cut with a tree-pruning compound as directed by the Contracting Officer.
- (c) The Contractor shall protect from damage all existing improvements and utilities (1) at or near the work site and (2) on adjacent property of a third party, the locations of which are made known to or should be known by the Contractor. Prior to disturbing the ground at the construction site, the Contractor shall ensure that all underground utility lines are clearly marked.
- (d) The Contractor shall shore up, brace, underpin, secure, and protect as necessary all foundations and other parts of existing structures adjacent to, adjoining, and in the vicinity of the site, which may be affected by the excavations or other operations connected with the construction of the project.
- (e) Any equipment temporarily removed as a result of work under this contract shall be protected, cleaned, and replaced in the same condition as at the time of award of this contract.

- (f) New work which connects to existing work shall correspond in all respects with that to which it connects and/or be similar to existing work unless otherwise required by the specifications.
- (g) No structural members shall be altered or in any way weakened without the written authorization of the Contracting Officer, unless such work is clearly specified in the plans or specifications.
- (h) If the removal of the existing work exposes discolored or unfinished surfaces, or work out of alignment, such surfaces shall be refinished, or the material replaced as necessary to make the continuous work uniform and harmonious. This, however, shall not be construed to require the refinishing or reconstruction of dissimilar finishes previously exposed, or finished surfaces in good condition, but in different planes or on different levels when brought together by the removal of intervening work, unless such refinishing or reconstruction is specified in the plans or specifications.
- (i) The Contractor shall give all required notices to any adjoining or adjacent property owner or other party before the commencement of any work.
- (j) The Contractor shall indemnify and save harmless the PHA from any damages on account of settlement or the loss of lateral support of adjoining property, any damages from changes in topography affecting drainage, and from all loss or expense and all damages for which the PHA may become liable in consequence of such injury or damage to adjoining and adjacent structures and their premises.
- (k) The Contractor shall repair any damage to vegetation, structures, equipment, utilities, or improvements, including those that are the property of a third party, resulting from failure to comply with the requirements of this contract or failure to exercise reasonable care in performing the work. If the Contractor fails or refuses to repair the damage promptly, the Contracting Officer may have the necessary work performed and charge the cost to the Contractor.

#### **17. Temporary Buildings and Transportation of Materials**

- (a) Temporary buildings (e.g., storage sheds, shops, offices, sanitary facilities) and utilities may be erected by the Contractor only with the approval of the Contracting Officer and shall be built with labor and materials furnished by the Contractor without expense to the PHA. The temporary buildings and utilities shall remain the property of the Contractor and shall be removed by the Contractor at its expense upon completion of the work. With the written consent of the Contracting Officer, the buildings and utilities may be abandoned and need not be removed.
- (b) The Contractor shall, as directed by the Contracting Officer, use only established roadways, or use temporary roadways constructed by the Contractor when and as authorized by the Contracting Officer. When materials are transported in prosecuting the work, vehicles shall not be loaded beyond the loading capacity recommended by the manufacturer of the vehicle or prescribed by any federal, state, or local law or regulation. When it is necessary to cross curbs or sidewalks, the Contractor shall protect them from damage. The Contractor shall repair or pay for the repair of any damaged curbs, sidewalks, or roads.

#### **18. Clean Air and Water**

The contractor shall comply with the Clean Air Act, as amended, 42 USC 7401 et seq., the Federal Water Pollution Control Water Act, as amended, 33 U.S.C. 1251 et seq., and standards issued pursuant thereto in the facilities in which this contract is to be performed.

#### **19. Energy Efficiency**

The Contractor shall comply with mandatory standards and policies relating to energy efficiency which are contained in the energy conservation plan issued in compliance with the Energy Policy and Conservation Act (Pub.L. 94-163) for the State in which the work under the contract is performed.

#### **20. Inspection and Acceptance of Construction**

- (a) Definitions. As used in this clause -
  - (1) "Acceptance" means the act of an authorized representative of the PHA by which the PHA approves and assumes ownership of the work performed under this contract. Acceptance may be partial or complete.
  - (2) "Inspection" means examining and testing the work performed under the contract (including, when appropriate, raw materials, equipment, components, and intermediate assemblies) to determine whether it conforms to contract requirements.
  - (3) "Testing" means that element of inspection that determines the properties or elements, including functional operation of materials, equipment, or their components, by the application of established scientific principles and procedures.
- (b) The Contractor shall maintain an adequate inspection system and perform such inspections as will ensure that the work performed under the contract conforms to contract requirements. All work is subject to PHA inspection and test at all places and at all reasonable times before acceptance to ensure strict compliance with the terms of the contract.
- (c) PHA inspections and tests are for the sole benefit of the PHA and do not: (1) relieve the Contractor of responsibility for providing adequate quality control measures; (2) relieve the Contractor of responsibility for loss or damage of the material before acceptance; (3) constitute or imply acceptance; or, (4) affect the continuing rights of the PHA after acceptance of the completed work under paragraph (j) below.
- (d) The presence or absence of the PHA inspector does not relieve the Contractor from any contract requirement, nor is the inspector authorized to change any term or condition of the specifications without the Contracting Officer's written authorization. All instructions and approvals with respect to the work shall be given to the Contractor by the Contracting Officer.
- (e) The Contractor shall promptly furnish, without additional charge, all facilities, labor, and material reasonably needed for performing such safe and convenient inspections and tests as may be required by the Contracting Officer. The PHA may charge to the Contractor any additional cost of inspection or test when work is not ready at the time specified by the Contractor for inspection or test, or when prior rejection makes reinspection or retest necessary. The PHA shall perform all inspections and tests in a manner that will not unnecessarily delay the work. Special, full size, and performance tests shall be performed as described in the contract.

- (f) The PHA may conduct routine inspections of the construction site on a daily basis.
- (g) The Contractor shall, without charge, replace or correct work found by the PHA not to conform to contract requirements, unless the PHA decides that it is in its interest to accept the work with an appropriate adjustment in contract price. The Contractor shall promptly segregate and remove rejected material from the premises.
- (h) If the Contractor does not promptly replace or correct rejected work, the PHA may (1) by contract or otherwise, replace or correct the work and charge the cost to the Contractor, or (2) terminate for default the Contractor's right to proceed.
- (i) If any work requiring inspection is covered up without approval of the PHA, it must, if requested by the Contracting Officer, be uncovered at the expense of the Contractor. If at any time before final acceptance of the entire work, the PHA considers it necessary or advisable, to examine work already completed by removing or tearing it out, the Contractor, shall on request, promptly furnish all necessary facilities, labor, and material. If such work is found to be defective or nonconforming in any material respect due to the fault of the Contractor or its subcontractors, the Contractor shall defray all the expenses of the examination and of satisfactory reconstruction. If, however, such work is found to meet the requirements of the contract, the Contracting Officer shall make an equitable adjustment to cover the cost of the examination and reconstruction, including, if completion of the work was thereby delayed, an extension of time.
- (j) The Contractor shall notify the Contracting Officer, in writing, as to the date when in its opinion all or a designated portion of the work will be substantially completed and ready for inspection. If the Architect determines that the state of preparedness is as represented, the PHA will promptly arrange for the inspection. Unless otherwise specified in the contract, the PHA shall accept, as soon as practicable after completion and inspection, all work required by the contract or that portion of the work the Contracting Officer determines and designates can be accepted separately. Acceptance shall be final and conclusive except for latent defects, fraud, gross mistakes amounting to fraud, or the PHA's right under any warranty or guarantee.

## 21. Use and Possession Prior to Completion

- (a) The PHA shall have the right to take possession of or use any completed or partially completed part of the work. Before taking possession of or using any work, the Contracting Officer shall furnish the Contractor a list of items of work remaining to be performed or corrected on those portions of the work that the PHA intends to take possession of or use. However, failure of the Contracting Officer to list any item of work shall not relieve the Contractor of responsibility for complying with the terms of the contract. The PHA's possession or use shall not be deemed an acceptance of any work under the contract.
- (b) While the PHA has such possession or use, the Contractor shall be relieved of the responsibility for (1) the loss of or damage to the work resulting from the PHA's possession or use, notwithstanding the terms of the clause entitled Permits and Codes herein; (2) all maintenance costs on the areas occupied; and, (3) furnishing heat, light, power, and water used in the areas

occupied without proper remuneration therefore. If prior possession or use by the PHA delays the progress of the work or causes additional expense to the Contractor, an equitable adjustment shall be made in the contract price or the time of completion, and the contract shall be modified in writing accordingly.

## 22. Warranty of Title

The Contractor warrants good title to all materials, supplies, and equipment incorporated in the work and agrees to deliver the premises together with all improvements thereon free from any claims, liens or charges, and agrees further that neither it nor any other person, firm or corporation shall have any right to a lien upon the premises or anything appurtenant thereto.

## 23. Warranty of Construction

- (a) In addition to any other warranties in this contract, the Contractor warrants, except as provided in paragraph (j) of this clause, that work performed under this contract conforms to the contract requirements and is free of any defect in equipment, material, or workmanship performed by the Contractor or any subcontractor or supplier at any tier. This warranty shall continue for a period of **18 Months** (one year unless otherwise indicated) from the date of final acceptance of the work. If the PHA takes possession of any part of the work before final acceptance, this warranty shall continue for a period of (one year unless otherwise indicated) from the date that the PHA takes possession.
- (b) The Contractor shall remedy, at the Contractor's expense, any failure to conform, or any defect. In addition, the Contractor shall remedy, at the Contractor's expense, any damage to PHA-owned or controlled real or personal property when the damage is the result of—
  - (1) The Contractor's failure to conform to contract requirements; or
  - (2) Any defects of equipment, material, workmanship or design furnished by the Contractor.
- (c) The Contractor shall restore any work damaged in fulfilling the terms and conditions of this clause. The Contractor's warranty with respect to work repaired or replaced will run for (one year unless otherwise indicated) from the date of repair or replacement.
- (d) The Contracting Officer shall notify the Contractor, in writing, within a reasonable time after the discovery of any failure, defect or damage.
- (e) If the Contractor fails to remedy any failure, defect, or damage within a reasonable time after receipt of notice, the PHA shall have the right to replace, repair or otherwise remedy the failure, defect, or damage at the Contractor's expense.
- (f) With respect to all warranties, express or implied, from subcontractors, manufacturers, or suppliers for work performed and materials furnished under this contract, the Contractor shall:
  - (1) Obtain all warranties that would be given in normal commercial practice;
  - (2) Require all warranties to be executed in writing, for the benefit of the PHA; and,
  - (3) Enforce all warranties for the benefit of the PHA.
- (g) In the event the Contractor's warranty under paragraph (a) of this clause has expired, the PHA may bring suit at its own expense to enforce a subcontractor's, manufacturer's or supplier's warranty.

- (h) Unless a defect is caused by the negligence of the Contractor or subcontractor or supplier at any tier, the Contractor shall not be liable for the repair of any defect of material or design furnished by the PHA nor for the repair of any damage that results from any defect in PHA furnished material or design.
- (i) Notwithstanding any provisions herein to the contrary, the establishment of the time periods in paragraphs (a) and (c) above relate only to the specific obligation of the Contractor to correct the work, and have no relationship to the time within which its obligation to comply with the contract may be sought to be enforced, nor to the time within which proceedings may be commenced to establish the Contractor's liability with respect to its obligation other than specifically to correct the work.
- (j) This warranty shall not limit the PHA's rights under the Inspection and Acceptance of Construction clause of this contract with respect to latent defects, gross mistakes or fraud.

**24. Prohibition Against Liens**

The Contractor is prohibited from placing a lien on the PHA's property. This prohibition shall apply to all subcontractors at any tier and all materials suppliers.

**Administrative Requirements**

**25. Contract Period**

The Contractor shall complete all work required under this this contract within **see special conditions** calendar days of the effective date of the contract, or within the time schedule established in the notice to proceed issued by the Contracting Officer.

**26. Order of Provisions**

In the event of a conflict between these General Conditions and the Specifications, the General Conditions shall prevail. In the event of a conflict between the contract and any applicable state or local law or regulation, the state or local law or regulation shall prevail; provided that such state or local law or regulation does not conflict with, or is less restrictive than applicable federal law, regulation, or Executive Order. In the event of such a conflict, applicable federal law, regulation, and Executive Order shall prevail.

**27. Payments**

- (a) The PHA shall pay the Contractor the price as provided in this contract.
- (b) The PHA shall make progress payments approximately every 30 days as the work proceeds, on estimates of work accomplished which meets the standards of quality established under the contract, as approved by the Contracting Officer. The PHA may, subject to written determination and approval of the Contracting Officer, make more frequent payments to contractors which are qualified small businesses.
- (c) Before the first progress payment under this contract, the Contractor shall furnish, in such detail as requested by the Contracting Officer, a breakdown of the total contract price showing the amount included therein for each principal category of the work, which shall substantiate

basis for determining progress payments. The breakdown shall be approved by the Contracting Officer and must be acceptable to HUD. If the contract covers more than one project, the Contractor shall furnish a separate breakdown for each. The values and quantities employed in making up this breakdown are for determining the amount of progress payments and shall not be construed as a basis for additions to or deductions from the contract price. The Contractor shall prorate its overhead and profit over the construction period of the contract.

- (d) The Contractor shall submit, on forms provided by the PHA, periodic estimates showing the value of the work performed during each period based upon the approved submitted not later than **10** days in advance of the date set for payment and are subject to correction and revision as required. The estimates must be approved by the Contracting Officer with the concurrence of the Architect prior to payment. If the contract covers more than one project, the Contractor shall furnish a separate progress payment estimate for each.
- (e) Along with each request for progress payments and the required estimates, the Contractor shall furnish the following certification, or payment shall not be made: I hereby certify, to the best of my knowledge and belief, that:
  - (1) The amounts requested are only for performance in accordance with the specifications, terms, and conditions of the contract;
  - (2) Payments to subcontractors and suppliers have been made from previous payments received under the contract, and timely payments will be made from the proceeds of the payment covered by this certification, in accordance with subcontract agreements; and,
  - (3) This request for progress payments does not include any amounts which the prime contractor intends to withhold or retain from a subcontractor or supplier in accordance with the terms and conditions of the subcontract.

\_\_\_\_\_  
Name:

\_\_\_\_\_  
Title:

\_\_\_\_\_  
Date:

- (f) Except as otherwise provided in State law, the PHA shall retain ten (10) percent of the amount of progress payments until completion and acceptance of all work under the contract; except, that if upon completion of 50 percent of the work, the Contracting Officer, after consulting with the Architect, determines that the Contractor's performance and progress are satisfactory, the PHA may make the remaining payments in full for the work subsequently completed. If the Contracting Officer subsequently determines that the Contractor's performance and progress are unsatisfactory, the PHA shall reinstate the ten (10) percent (or other percentage as provided in State law) retainage until such time as the Contracting Officer determines that performance and progress are satisfactory.
- (g) The Contracting Officer may authorize material delivered on the site and preparatory work done to be taken into consideration when computing progress payments.

Material delivered to the Contractor at locations other than the site may also be taken into consideration if the Contractor furnishes satisfactory evidence that (1) it has acquired title to such material; (2) the material is properly stored in a bonded warehouse, storage yard, or similar suitable place as may be approved by the Contracting Officer; (3) the material is insured to cover its full value; and (4) the material will be used to perform this contract. Before any progress payment which includes delivered material is made, the Contractor shall furnish such documentation as the Contracting Officer may require to assure the protection of the PHA's interest in such materials. The Contractor shall remain responsible for such stored material notwithstanding the transfer of title to the PHA.

- (h) All material and work covered by progress payments made shall, at the time of payment become the sole property of the PHA, but this shall not be construed as (1) relieving the Contractor from the sole responsibility for all material and work upon which payments have been made or the restoration of any damaged work; or, (2) waiving the right of the PHA to require the fulfillment of all of the terms of the contract. In the event the work of the Contractor has been damaged by other contractors or persons other than employees of the PHA in the course of their employment, the Contractor shall restore such damaged work without cost to the PHA and to seek redress for its damage only from those who directly caused it.
- (i) The PHA shall make the final payment due the Contractor under this contract after (1) completion and final acceptance of all work; and (2) presentation of release of all claims against the PHA arising by virtue of this contract, other than claims, in stated amounts, that the Contractor has specifically excepted from the operation of the release. Each such exception shall embrace no more than one claim, the basis and scope of which shall be clearly defined. The amounts for such excepted claims shall not be included in the request for final payment. A release may also be required of the assignee if the Contractor's claim to amounts payable under this contract has been assigned.
- (j) Prior to making any payment, the Contracting Officer may require the Contractor to furnish receipts or other evidence of payment from all persons performing work and supplying material to the Contractor, if the Contracting Officer determines such evidence is necessary to substantiate claimed costs.
- (k) The PHA shall not; (1) determine or adjust any claims for payment or disputes arising there under between the Contractor and its subcontractors or material suppliers; or, (2) withhold any moneys for the protection of the subcontractors or material suppliers. The failure or refusal of the PHA to withhold moneys from the Contractor shall in no wise impair the obligations of any surety or sureties under any bonds furnished under this contract.

## 28. Contract Modifications

- (a) Only the Contracting Officer has authority to modify any term or condition of this contract. Any contract modification shall be authorized in writing.
- (b) The Contracting Officer may modify the contract unilaterally (1) pursuant to a specific authorization stated in a contract clause (e.g., Changes); or (2) for administrative matters which do not change the rights or

responsibilities of the parties (e.g., change in the PHA address). All other contract modifications shall be in the form of supplemental agreements signed by the Contractor and the Contracting Officer.

- (c) When a proposed modification requires the approval of HUD prior to its issuance (e.g., a change order that exceeds the PHA's approved threshold), such modification shall not be effective until the required approval is received by the PHA.

## 29. Changes

- (a) The Contracting Officer may, at any time, without notice to the sureties, by written order designated or indicated to be a change order, make changes in the work within the general scope of the contract including changes:
  - (1) In the specifications (including drawings and designs);
  - (2) In the method or manner of performance of the work;
  - (3) PHA-furnished facilities, equipment, materials, services, or site; or,
  - (4) Directing the acceleration in the performance of the work.
- (b) Any other written order or oral order (which, as used in this paragraph (b), includes direction, instruction, interpretation, or determination) from the Contracting Officer that causes a change shall be treated as a change order under this clause; provided, that the Contractor gives the Contracting Officer written notice stating (1) the date, circumstances and source of the order and (2) that the Contractor regards the order as a change order.
- (c) Except as provided in this clause, no order, statement or conduct of the Contracting Officer shall be treated as a change under this clause or entitle the Contractor to an equitable adjustment.
- (d) If any change under this clause causes an increase or decrease in the Contractor's cost of, or the time required for the performance of any part of the work under this contract, whether or not changed by any such order, the Contracting Officer shall make an equitable adjustment and modify the contract in writing. However, except for a adjustment based on defective specifications, no proposal for any change under paragraph (b) above shall be allowed for any costs incurred more than 20 days (5 days for oral orders) before the Contractor gives written notice as required. In the case of defective specifications for which the PHA is responsible, the equitable adjustment shall include any increased cost reasonably incurred by the Contractor in attempting to comply with the defective specifications.
- (e) The Contractor must assert its right to an adjustment under this clause within 30 days after (1) receipt of a written change order under paragraph (a) of this clause, or (2) the furnishing of a written notice under paragraph (b) of this clause, by submitting a written statement describing the general nature and the amount of the proposal. If the facts justify it, the Contracting Officer may extend the period for submission. The proposal may be included in the notice required under paragraph (b) above. No proposal by the Contractor for an equitable adjustment shall be allowed if asserted after final payment under this contract.
- (f) The Contractor's written proposal for equitable adjustment shall be submitted in the form of a lump sum proposal supported with an itemized breakdown of all increases and decreases in the contract in at least the following details:



- (1) Direct Costs. Materials (list individual items, the quantity and unit cost of each, and the aggregate cost); Transportation and delivery costs associated with materials; Labor breakdowns by hours or unit costs (identified with specific work to be performed); Construction equipment exclusively necessary for the change; Costs of preparation and/ or revision to shop drawings resulting from the change; Worker's Compensation and Public Liability Insurance; Employment taxes under FICA and FUTA; and, Bond Costs when size of change warrants revision.
- (2) Indirect Costs. Indirect costs may include overhead, general and administrative expenses, and fringe benefits not normally treated as direct costs.
- (3) Profit. The amount of profit shall be negotiated and may vary according to the nature, extent, and complexity of the work required by the change. The allowability of the direct and indirect costs shall be determined in accordance with the Contract Cost Principles and Procedures for Commercial Firms in Part 31 of the Federal Acquisition Regulation (48 CFR 1-31), as implemented by HUD Handbook 2210.18, in effect on the date of this contract. The Contractor shall not be allowed a profit on the profit received by any subcontractor. Equitable adjustments for deleted work shall include a credit for profit and may include a credit for indirect costs. On proposals covering both increases and decreases in the amount of the contract, the application of indirect costs and profit shall be on the net-change in direct costs for the Contractor or subcontractor performing the work.
- (g) The Contractor shall include in the proposal its request for time extension (if any), and shall include sufficient information and dates to demonstrate whether and to what extent the change will delay the completion of the contract in its entirety.
- (h) The Contracting Officer shall act on proposals within 30 days after their receipt, or notify the Contractor of the date when such action will be taken.
- (i) Failure to reach an agreement on any proposal shall be a dispute under the clause entitled Disputes herein. Nothing in this clause, however, shall excuse the Contractor from proceeding with the contract as changed.
- (j) Except in an emergency endangering life or property, no change shall be made by the Contractor without a prior order from the Contracting Officer.

### 30. Suspension of Work

- (a) The Contracting Officer may order the Contractor in writing to suspend, delay, or interrupt all or any part of the work of this contract for the period of time that the Contracting Officer determines appropriate for the convenience of the PHA.
- (b) If the performance of all or any part of the work is, for an unreasonable period of time, suspended, delayed, or interrupted (1) by an act of the Contracting Officer in the administration of this contract, or (2) by the Contracting Officer's failure to act within the time specified (or within a reasonable time if not specified) in this contract an adjustment shall be made for any increase in the cost of performance of the contract (excluding profit) necessarily caused by such unreasonable suspension, delay, or interruption and the contract modified in writing accordingly. However, no adjustment shall be made under this clause for any suspension, delay, or interruption to the extent that performance would have

been so suspended, delayed, or interrupted by any other cause, including the fault or negligence of the Contractor or for which any equitable adjustment is provided for or excluded under any other provision of this contract.

- (c) A claim under this clause shall not be allowed (1) for any costs incurred more than 20 days before the Contractor shall have notified the Contracting Officer in writing of the act or failure to act involved (but this requirement shall not apply as to a claim resulting from a suspension order); and, (2) unless the claim, in an amount stated, is asserted in writing as soon as practicable after the termination of the suspension, delay, or interruption, but not later than the date of final payment under the contract.

### 31. Disputes

- (a) "Claim," as used in this clause, means a written demand or written assertion by one of the contracting parties seeking, as a matter of right, the payment of money in a sum certain, the adjustment or interpretation of contract terms, or other relief arising under or relating to the contract. A claim arising under the contract, unlike a claim relating to the contract, is a claim that can be resolved under a contract clause that provides for the relief sought by the claimant. A voucher, invoice, or other routine request for payment that is not in dispute when submitted is not a claim. The submission may be converted to a claim by complying with the requirements of this clause, if it is disputed either as to liability or amount or is not acted upon in a reasonable time.
- (b) Except for disputes arising under the clauses entitled Labor Standards - Davis Bacon and Related Acts, herein, all disputes arising under or relating to this contract, including any claims for damages for the alleged breach thereof which are not disposed of by agreement, shall be resolved under this clause.
- (c) All claims by the Contractor shall be made in writing and submitted to the Contracting Officer for a written decision. A claim by the PHA against the Contractor shall be subject to a written decision by the Contracting Officer.
- (d) The Contracting Officer shall, within 60 (unless otherwise indicated) days after receipt of the request, decide the claim or notify the Contractor of the date by which the decision will be made.
- (e) The Contracting Officer's decision shall be final unless the Contractor (1) appeals in writing to a higher level in the PHA in accordance with the PHA's policy and procedures, (2) refers the appeal to an independent mediator or arbitrator, or (3) files suit in a court of competent jurisdiction. Such appeal must be made within (30 unless otherwise indicated) days after receipt of the Contracting Officer's decision.
- (f) The Contractor shall proceed diligently with performance of this contract, pending final resolution of any request for relief, claim, appeal, or action arising under or relating to the contract, and comply with any decision of the Contracting Officer.

### 32. Default

- (a) If the Contractor refuses or fails to prosecute the work, or any separable part thereof, with the diligence that will insure its completion within the time specified in this contract, or any extension thereof, or fails to complete said work within this time, the Contracting Officer may, by written notice to the Contractor, terminate the right to

proceed with the work (or separable part of the work) that has been delayed. In this event, the PHA may take over the work and complete it, by contract or otherwise, and may take possession of and use any materials, equipment, and plant on the work site necessary for completing the work. The Contractor and its sureties shall be liable for any damage to the PHA resulting from the Contractor's refusal or failure to complete the work within the specified time, whether or not the Contractor's right to proceed with the work is terminated. This liability includes any increased costs incurred by the PHA in completing the work.

- (b) The Contractor's right to proceed shall not be terminated or the Contractor charged with damages under this clause if—
- (1) The delay in completing the work arises from unforeseeable causes beyond the control and without the fault or negligence of the Contractor. Examples of such causes include (i) acts of God, or of the public enemy, (ii) acts of the PHA or other governmental entity in either its sovereign or contractual capacity, (iii) acts of another contractor in the performance of a contract with the PHA, (iv) fires, (v) floods, (vi) epidemics, (vii) quarantine restrictions, (viii) strikes, (ix) freight embargoes, (x) unusually severe weather, or (xi) delays of subcontractors or suppliers at any tier arising from unforeseeable causes beyond the control and without the fault or negligence of both the Contractor and the subcontractors or suppliers; and
  - (2) The Contractor, within days (10 days unless otherwise indicated) from the beginning of such delay (unless extended by the Contracting Officer) notifies the Contracting Officer in writing of the causes of delay. The Contracting Officer shall ascertain the facts and the extent of the delay. If, in the judgment of the Contracting Officer, the findings of fact warrant such action, time for completing the work shall be extended by written modification to the contract. The findings of the Contracting Officer shall be reduced to a written decision which shall be subject to the provisions of the Disputes clause of this contract.
- (c) If, after termination of the Contractor's right to proceed, it is determined that the Contractor was not in default, or that the delay was excusable, the rights and obligations of the parties will be the same as if the termination had been for convenience of the PHA.

### 33. Liquidated Damages

- (a) If the Contractor fails to complete the work within the time specified in the contract, or any extension, as specified in the clause entitled Default of this contract, the Contractor shall pay to the PHA as liquidated damages, the sum of \$ 150.00 [Contracting Officer insert amount] for each day of delay. If different completion dates are specified in the contract for separate parts or stages of the work, the amount of liquidated damages shall be assessed on those parts or stages which are delayed. To the extent that the Contractor's delay or nonperformance is excused under another clause in this contract, liquidated damages shall not be due the PHA. The Contractor remains liable for damages caused other than by delay.
- (b) If the PHA terminates the Contractor's right to proceed, the resulting damage will consist of liquidated damages until such reasonable time as may be required for final

completion of the work together with any increased costs occasioned the PHA in completing the work.

- (c) If the PHA does not terminate the Contractor's right to proceed, the resulting damage will consist of liquidated damages until the work is completed or accepted.

### 34. Termination for Convenience

- (a) The Contracting Officer may terminate this contract in whole, or in part, whenever the Contracting Officer determines that such termination is in the best interest of the PHA. Any such termination shall be effected by delivery to the Contractor of a Notice of Termination specifying the extent to which the performance of the work under the contract is terminated, and the date upon which such termination becomes effective.
- (b) If the performance of the work is terminated, either in whole or in part, the PHA shall be liable to the Contractor for reasonable and proper costs resulting from such termination upon the receipt by the PHA of a properly presented claim setting out in detail: (1) the total cost of the work performed to date of termination less the total amount of contract payments made to the Contractor; (2) the cost (including reasonable profit) of settling and paying claims under subcontracts and material orders for work performed and materials and supplies delivered to the site, payment for which has not been made by the PHA to the Contractor or by the Contractor to the subcontractor or supplier; (3) the cost of preserving and protecting the work already performed until the PHA or assignee takes possession thereof or assumes responsibility therefore; (4) the actual or estimated cost of legal and accounting services reasonably necessary to prepare and present the termination claim to the PHA; and (5) an amount constituting a reasonable profit on the value of the work performed by the Contractor.
- (c) The Contracting Officer will act on the Contractor's claim within days (60 days unless otherwise indicated) of receipt of the Contractor's claim.
- (d) Any disputes with regard to this clause are expressly made subject to the provisions of the Disputes clause of this contract.

### 35. Assignment of Contract

The Contractor shall not assign or transfer any interest in this contract; except that claims for monies due or to become due from the PHA under the contract may be assigned to a bank, trust company, or other financial institution. Such assignments of claims shall only be made with the written concurrence of the Contracting Officer. If the Contractor is a partnership, this contract shall inure to the benefit of the surviving or remaining member(s) of such partnership as approved by the Contracting Officer.

### 36. Insurance

- (a) Before commencing work, the Contractor and each subcontractor shall furnish the PHA with certificates of insurance showing the following insurance is in force and will insure all operations under the Contract:
- (1) Workers' Compensation, in accordance with state or Territorial Workers' Compensation laws.
  - (2) Commercial General Liability with a combined single limit for bodily injury and property damage of not less than \$ 1,000,000.00 [Contracting Officer insert amount]

per occurrence to protect the Contractor and each subcontractor against claims for bodily injury or death and damage to the property of others. This shall cover the use of all equipment, hoists, and vehicles on the site(s) not covered by Automobile Liability under (3) below. If the Contractor has a "claims made" policy, then the following additional requirements apply: the policy must provide a "retroactive date" which must be on or before the execution date of the Contract; and the extended reporting period may not be less than five years following the completion date of the Contract.

- (3) Automobile Liability on owned and non-owned motor vehicles used on the site(s) or in connection therewith for a combined single limit for bodily injury and property damage of not less than \$ 500,000.00 [Contracting Officer insert amount] per occurrence.
- (b) Before commencing work, the Contractor shall furnish the PHA with a certificate of insurance evidencing that Builder's Risk (fire and extended coverage) Insurance on all work in place and/or materials stored at the building site(s), including foundations and building equipment, is in force. The Builder's Risk Insurance shall be for the benefit of the Contractor and the PHA as their interests may appear and each shall be named in the policy or policies as an insured. The Contractor in installing equipment supplied by the PHA shall carry insurance on such equipment from the time the Contractor takes possession thereof until the Contract work is accepted by the PHA. The Builder's Risk Insurance need not be carried on excavations, piers, footings, or foundations until such time as work on the superstructure is started. It need not be carried on landscape work. Policies shall furnish coverage at all times for the full cash value of all completed construction, as well as materials in place and/or stored at the site(s), whether or not partial payment has been made by the PHA. The Contractor may terminate this insurance on buildings as of the date taken over for occupancy by the PHA. The Contractor is not required to carry Builder's Risk Insurance for modernization work which does not involve structural alterations or additions and where the PHA's existing fire and extended coverage policy can be endorsed to include such work.
- (c) All insurance shall be carried with companies which are financially responsible and admitted to do business in the State in which the project is located. If any such insurance is due to expire during the construction period, the Contractor (including subcontractors, as applicable) shall not permit the coverage to lapse and shall furnish evidence of coverage to the Contracting Officer. All certificates of insurance, as evidence of coverage, shall provide that no coverage may be canceled or non-renewed by the insurance company until at least 30 days prior written notice has been given to the Contracting Officer.

### 37. Subcontracts

- (a) Definitions. As used in this contract -
- (1) "Subcontract" means any contract, purchase order, or other purchase agreement, including modifications and change orders to the foregoing, entered into by a subcontractor to furnish supplies, materials, equipment, and services for the performance of the prime contractor or a subcontract.

(2) "Subcontractor" means any supplier, vendor, or firm that furnishes supplies, materials, equipment, or services to or for the Contractor or another subcontractor.

- (b) The Contractor shall not enter into any subcontract with any subcontractor who has been temporarily denied participation in a HUD program or who has been suspended or debarred from participating in contracting programs by any agency of the United States Government or of the state in which the work under this contract is to be performed.
- (c) The Contractor shall be as fully responsible for the acts or omissions of its subcontractors, and of persons either directly or indirectly employed by them as for the acts or omissions of persons directly employed by the Contractor.
- (d) The Contractor shall insert appropriate clauses in all subcontracts to bind subcontractors to the terms and conditions of this contract insofar as they are applicable to the work of subcontractors.
- (e) Nothing contained in this contract shall create any contractual relationship between any subcontractor and the PHA or between the subcontractor and HUD.

### 38. Subcontracting with Small and Minority Firms, Women's Business Enterprise, and Labor Surplus Area Firms

The Contractor shall take the following steps to ensure that, whenever possible, subcontracts are awarded to small business firms, minority firms, women's business enterprises, and labor surplus area firms:

- (a) Placing qualified small and minority businesses and women's business enterprises on solicitation lists;
- (b) Ensuring that small and minority businesses and women's business enterprises are solicited whenever they are potential sources;
- (c) Dividing total requirements, when economically feasible, into smaller tasks or quantities to permit maximum participation by small and minority businesses and women's business enterprises;
- (d) Establishing delivery schedules, where the requirements of the contract permit, which encourage participation by small and minority businesses and women's business enterprises; and
- (e) Using the services and assistance of the U.S. Small Business Administration, the Minority Business Development Agency of the U.S. Department of Commerce, and State and local governmental small business agencies.

### 39. Equal Employment Opportunity

During the performance of this contract, the Contractor agrees as follows:

- (a) The Contractor shall not discriminate against any employee or applicant for employment because of race, color, religion, sex, national origin, or handicap.
- (b) The Contractor shall take affirmative action to ensure that applicants are employed, and that employees are treated during employment without regard to their race, color, religion, sex, national origin, or handicap. Such action shall include, but not be limited to, (1) employment, (2) upgrading, (3) demotion, (4) transfer, (5) recruitment or recruitment advertising, (6) layoff or termination, (7) rates of pay or other forms of compensation, and (8) selection for training, including apprenticeship.

- (c) The Contractor shall post in conspicuous places available to employees and applicants for employment the notices to be provided by the Contracting Officer that explain this clause.
- (d) The Contractor shall, in all solicitations or advertisements for employees placed by or on behalf of the Contractor, state that all qualified applicants will receive consideration for employment without regard to race, color, religion, sex, national origin, or handicap.
- (e) The Contractor shall send, to each labor union or representative of workers with which it has a collective bargaining agreement or other contract or understanding, the notice to be provided by the Contracting Officer advising the labor union or workers' representative of the Contractor's commitments under this clause, and post copies of the notice in conspicuous places available to employees and applicants for employment.
- (f) The Contractor shall comply with Executive Order 11246, as amended, and the rules, regulations, and orders of the Secretary of Labor.
- (g) The Contractor shall furnish all information and reports required by Executive Order 11246, as amended, Section 503 of the Rehabilitation Act of 1973, as amended, and by rules, regulations, and orders of the Secretary of Labor, or pursuant thereto. The Contractor shall permit access to its books, records, and accounts by the Secretary of Labor for purposes of investigation to ascertain compliance with such rules, regulations, and orders.
- (h) In the event of a determination that the Contractor is not in compliance with this clause or any rule, regulation, or order of the Secretary of Labor, this contract may be canceled, terminated, or suspended in whole or in part, and the Contractor may be declared ineligible for further Government contracts, or Federally assisted construction contracts under the procedures authorized in Executive Order 11246, as amended. In addition, sanctions may be imposed and remedies invoked against the Contractor as provided in Executive Order 11246, as amended, the rules, regulations, and orders of the Secretary of Labor, or as otherwise provided by law.
- (i) The Contractor shall include the terms and conditions of this clause in every subcontract or purchase order unless exempted by the rules, regulations, or orders of the Secretary of Labor issued under Executive Order 11246, as amended, so that these terms and conditions will be binding upon each subcontractor or vendor. The Contractor shall take such action with respect to any subcontract or purchase order as the Secretary of Housing and Urban Development or the Secretary of Labor may direct as a means of enforcing such provisions, including sanctions for noncompliance; provided that if the Contractor becomes involved in, or is threatened with, litigation with a subcontractor or vendor as a result of such direction, the Contractor may request the United States to enter into the litigation to protect the interests of the United States.
- (j) Compliance with the requirements of this clause shall be to the maximum extent consistent with, but not in derogation of, compliance with section 7(b) of the Indian Self-Determination and Education Assistance Act and the Indian Preference clause of this contract.
- 40. Employment, Training, and Contracting Opportunities for Low-Income Persons, Section 3 of the Housing and Urban Development Act of 1968.**
- (a) The work to be performed under this contract is subject to the requirements of section 3 of the Housing and Urban Development Act of 1968, as amended, 12 U.S.C. 1701u (section 3). The purpose of section 3 is to ensure that employment and other economic opportunities generated by HUD assistance or HUD-assisted projects covered by section 3, shall, to the greatest extent feasible, be directed to low- and very low-income persons, particularly persons who are recipients of HUD assistance for housing.
- (b) The parties to this contract agree to comply with HUD's regulations in 24 CFR Part 135, which implement section 3. As evidenced by their execution of this contract, the parties to this contract certify that they are under no contractual or other impediment that would prevent them from complying with the Part 135 regulations.
- (c) The contractor agrees to send to each labor organization or representative of workers with which the contractor has a collective bargaining agreement or other understanding, if any, a notice advising the labor organization or workers' representative of the contractor's commitments under this section 3 clause, and will post copies of the notice in conspicuous places at the work site where both employees and applicants for training and employment positions can see the notice. The notice shall describe the section 3 preference, shall set forth minimum number and job titles subject to hire, availability of apprenticeship and training positions, the qualifications for each; and the name and location of the person(s) taking applications for each of the positions; and the anticipated date the work shall begin.
- (d) The contractor agrees to include this section 3 clause in every subcontract subject to compliance with regulations in 24 CFR Part 135, and agrees to take appropriate action, as provided in an applicable provision of the subcontract or in this section 3 clause, upon a finding that the subcontractor is in violation of the regulations in 24 CFR Part 135. The contractor will not subcontract with any subcontractor where the contractor has notice or knowledge that the subcontractor has been found in violation of the regulations in 24 CFR Part 135.
- (e) The contractor will certify that any vacant employment positions, including training positions, that are filled (1) after the contractor is selected but before the contract is executed, and (2) with persons other than those to whom the regulations of 24 CFR Part 135 require employment opportunities to be directed, were not filled to circumvent the contractor's obligations under 24 CFR Part 135.
- (f) Noncompliance with HUD's regulations in 24 CFR Part 135 may result in sanctions, termination of this contract for default, and debarment or suspension from future HUD assisted contracts.
- (g) With respect to work performed in connection with section 3 covered Indian housing assistance, section 7(b) of the Indian Self-Determination and Education Assistance Act (25 U.S.C. 450e) also applies to the work to be performed under this contract. Section 7(b) requires that to the greatest extent feasible (i) preference and opportunities for training and employment shall be given to Indians, and (ii) preference in the award of contracts and subcontracts shall be given to Indian organizations and Indian-owned Economic Enterprises. Parties to this contract that are subject to the provisions of section 3 and section 7(b) agree to comply with section 3 to the maximum extent feasible, but not in derogation of compliance with section 7(b).

---

#### 41. Interest of Members of Congress

No member of or delegate to the Congress of the United States of America shall be admitted to any share or part of this contract or to any benefit that may arise therefrom.

#### 42. Interest of Members, Officers, or Employees and Former Members, Officers, or Employees

No member, officer, or employee of the PHA, no member of the governing body of the locality in which the project is situated, no member of the governing body of the locality in which the PHA was activated, and no other public official of such locality or localities who exercises any functions or responsibilities with respect to the project, shall, during his or her tenure, or for one year thereafter, have any interest, direct or indirect, in this contract or the proceeds thereof.

#### 43. Limitations on Payments made to Influence Certain Federal Financial Transactions

- (a) The Contractor agrees to comply with Section 1352 of Title 31, United States Code which prohibits the use of Federal appropriated funds to pay any person for influencing or attempting to influence an officer or employee of any agency, a Member of Congress, and officer or employee of Congress, or an employee of a Member of Congress in connection with any of the following covered Federal actions: the awarding of any Federal contract; the making of any Federal grant; the making of any Federal loan; the entering into of any cooperative agreement; or the modification of any Federal contract, grant, loan, or cooperative agreement.
- (b) The Contractor further agrees to comply with the requirement of the Act to furnish a disclosure (OMB Standard Form LLL, Disclosure of Lobbying Activities) if any funds other than Federal appropriated funds (including profit or fee received under a covered Federal transaction) have been paid, or will be paid, to any person for influencing or attempting to influence an officer or employee of any agency, a Member of Congress, an officer or employee of Congress, or an employee of a Member of Congress in connection with a Federal contract, grant, loan, or cooperative agreement.

#### 44. Royalties and Patents

The Contractor shall pay all royalties and license fees. It shall defend all suits or claims for infringement of any patent rights and shall save the PHA harmless from loss on account thereof; except that the PHA shall be responsible for all such loss when a particular design, process or the product of a particular manufacturer or manufacturers is specified and the Contractor has no reason to believe that the specified design, process, or product is an infringement. If, however, the Contractor has reason to believe that any design, process or product specified is an infringement of a patent, the Contractor shall promptly notify the Contracting Officer. Failure to give such notice shall make the Contractor responsible for resultant loss.

#### 45. Examination and Retention of Contractor's Records

- (a) The PHA, HUD, or Comptroller General of the United States, or any of their duly authorized representatives shall, until 3 years after final payment under this contract, have access to and the right to examine any of the Contractor's directly pertinent books, documents, papers, or other records involving transactions related to this contract for the purpose of making audit, examination, excerpts, and transcriptions.
- (b) The Contractor agrees to include in first-tier subcontracts under this contract a clause substantially the same as paragraph (a) above. "Subcontract," as used in this clause, excludes purchase orders not exceeding \$10,000.
- (c) The periods of access and examination in paragraphs (a) and (b) above for records relating to (1) appeals under the Disputes clause of this contract, (2) litigation or settlement of claims arising from the performance of this contract, or (3) costs and expenses of this contract to which the PHA, HUD, or Comptroller General or any of their duly authorized representatives has taken exception shall continue until disposition of such appeals, litigation, claims, or exceptions.

#### 46. Labor Standards - Davis-Bacon and Related Acts

If the total amount of this contract exceeds \$2,000, the Federal labor standards set forth in the clause below shall apply to the development or construction work to be performed under the contract.

- (a) Minimum Wages.
  - (1) All laborers and mechanics employed under this contract in the development or construction of the project(s) involved will be paid unconditionally and not less often than once a week, and without subsequent deduction or rebate on any account (except such payroll deductions as are permitted by regulations issued by the Secretary of Labor under the Copeland Act (29 CFR Part 3)), the full amount of wages and bona fide fringe benefits (or cash equivalents thereof) due at time of payment computed at rates not less than those contained in the wage determination of the Secretary of Labor which is attached hereto and made a part hereof, regardless of any contractual relationship which may be alleged to exist between the Contractor and such laborers and mechanics. Contributions made or costs reasonably anticipated for bona fide fringe benefits under Section 1(b)(2) of the Davis-Bacon Act on behalf of laborers or mechanics are considered wages paid to such laborers or mechanics, subject to the provisions of 29 CFR 5.5(a)(1)(iv); also, regular contributions made or costs incurred for more than a weekly period (but not less often than quarterly) under plans, funds, or programs which cover the regular weekly period, are deemed to be constructively made or incurred during such weekly period. Such laborers and mechanics shall be paid the appropriate wage rate and fringe benefits in the wage determination for the classification of work actually performed, without regard to skill, except as provided in 29 CFR 5.5(a)(4). Laborers or mechanics performing work in more than one classification may be compensated at the rate specified for each classification for the time actually worked therein; provided, that the employer's payroll records accurately set forth the time spent in each classification in which work is performed. The wage determination (including any additional classification and wage rates conformed under 29 CFR 5.5(a)(1)(ii) and the Davis-Bacon poster (WH-1321) shall

---

be posted at all times by the Contractor and its subcontractors at the site of the work in a prominent and accessible place where it can be easily seen by the workers.

- (2) (i) Any class of laborers or mechanics, including helpers, which is not listed in the wage determination and which is to be employed under the contract shall be classified in conformance with the wage determination. HUD shall approve an additional classification and wage rate and fringe benefits therefor only when all the following criteria have been met: (A) The work to be performed by the classification requested is not performed by a classification in the wage determination; and (B) The classification is utilized in the area by the construction industry; and (C) The proposed wage rate, including any bona fide fringe benefits, bears a reasonable relationship to the wage rates contained in the wage determination.
- (ii) If the Contractor and the laborers and mechanics to be employed in the classification (if known), or their representatives, and HUD or its designee agree on the classification and wage rate (including the amount designated for fringe benefits where appropriate), a report of the action taken shall be sent by HUD or its designee to the Administrator of the Wage and Hour Division, Employee Standards Administration, U.S. Department of Labor, Washington, DC 20210. The Administrator, or an authorized representative, will approve, modify, or disapprove every additional classification action within 30 days of receipt and so advise HUD or its designee or will notify HUD or its designee within the 30-day period that additional time is necessary.
- (iii) In the event the Contractor, the laborers or mechanics to be employed in the classification or their representatives, and HUD or its designee do not agree on the proposed classification and wage rate (including the amount designated for fringe benefits, where appropriate), HUD or its designee shall refer the questions, including the views of all interested parties and the recommendation of HUD or its designee, to the Administrator of the Wage and Hour Division for determination. The Administrator, or an authorized representative, will issue a determination within 30 days of receipt and so advise HUD or its designee or will notify HUD or its designee within the 30-day period that additional time is necessary.
- (iv) The wage rate (including fringe benefits where appropriate) determined pursuant to subparagraphs (a)(2)(ii) or (iii) of this clause shall be paid to all workers performing work in the classification under this contract from the first day on which work is performed in classification.
- (3) Whenever the minimum wage rate prescribed in the contract for a class of laborers or mechanics includes a fringe benefit which is not expressed as an hourly rate, the Contractor shall either pay the benefit as stated in the wage determination or shall pay another bona fide fringe benefit or an hourly cash equivalent thereof.
- (4) If the Contractor does not make payments to a trustee or other third person, the Contractor may consider as part of the wages of any laborer or mechanic the

amount of any costs reasonably anticipated in providing bona fide fringe benefits under a plan or program; provided, that the Secretary of Labor has found, upon the written request of the Contractor, that the applicable standards of the Davis-Bacon Act have been met. The Secretary of Labor may require the Contractor to set aside in a separate account assets for the meeting of obligations under the plan or program.

- (b) Withholding of funds. HUD or its designee shall, upon its own action or upon written request of an authorized representative of the Department of Labor, withhold or cause to be withheld from the Contractor under this contract or any other Federal contract with the same prime Contractor, or any other Federally-assisted contract subject to Davis-Bacon prevailing wage requirements, which is held by the same prime Contractor, so much of the accrued payments or advances as may be considered necessary to pay laborers and mechanics, including apprentices, trainees, and helpers, employed by the Contractor or any subcontractor the full amount of wages required by the contract. In the event of failure to pay any laborer or mechanic, including any apprentice, trainee, or helper, employed or working in the construction or development of the project, all or part of the wages required by the contract, HUD or its designee may, after written notice to the Contractor, take such action as may be necessary to cause the suspension of any further payment, advance, or guarantee of funds until such violations have ceased. HUD or its designee may, after written notice to the Contractor, disburse such amounts withheld for and on account of the Contractor or subcontractor to the respective employees to whom they are due.
- (c) Payrolls and basic records.
- (1) Payrolls and basic records relating thereto shall be maintained by the Contractor during the course of the work and preserved for a period of three years thereafter for all laborers and mechanics working in the construction or development of the project. Such records shall contain the name, address, and social security number of each such worker, his or her correct classification, hourly rates of wages paid (including rates of contributions or costs anticipated for bona fide fringe benefits or cash equivalents thereof of the types described in section 1(b)(2)(B) of the Davis-Bacon Act), daily and weekly number of hours worked, deductions made, and actual wages paid. Whenever the Secretary of Labor has found, under 29 CFR 5.5(a)(1)(iv), that the wages of any laborer or mechanic include the amount of costs reasonably anticipated in providing benefits under a plan or program described in section 1(b)(2)(B) of the Davis-Bacon Act, the Contractor shall maintain records which show that the commitment to provide such benefits is enforceable, that the plan or program is financially responsible, and that the plan or program has been communicated in writing to the laborers or mechanics affected, and records which show the costs anticipated or the actual cost incurred in providing such benefits. Contractors employing apprentices or trainees under approved programs shall maintain written evidence of the registration of apprenticeship programs and certification of trainee programs, the registration of the apprentices and trainees, and the ratios and wage rates prescribed in the applicable programs.

- (2) (i) The Contractor shall submit weekly for each week in which any contract work is performed a copy of all payrolls to the Contracting Officer for transmission to HUD or its designee. The payrolls submitted shall set out accurately and completely all of the information required to be maintained under subparagraph (c)(1) of this clause. This information may be submitted in any form desired. Optional Form WH-347 (Federal Stock Number 029-005-00014-1) is available for this purpose and may be purchased from the Superintendent of Documents, U.S. Government Printing Office, Washington, D.C. 20402. The Contractor is responsible for the submission of copies of payrolls by all subcontractors. (Approved by the Office of Management and Budget under OMB Control Number 1214-0149.)
- (ii) Each payroll submitted shall be accompanied by a "Statement of Compliance," signed by the Contractor or subcontractor or his or her agent who pays or supervises the payment of the persons employed under the contract and shall certify the following:
- (A) That the payroll for the payroll period contains the information required to be maintained under paragraph (c) (1) of this clause and that such information is correct and complete;
- (B) That each laborer or mechanic (including each helper, apprentice, and trainee) employed on the contract during the payroll period has been paid the full weekly wages earned, without rebate, either directly or indirectly, and that no deductions have been made either directly or indirectly from the full wages earned, other than permissible deductions as set forth in 29 CFR Part 3; and
- (C) That each laborer or mechanic has been paid not less than the applicable wage rates and fringe benefits or cash equivalents for the classification of work performed, as specified in the applicable wage determination incorporated into the contract.
- (iii) The weekly submission of a properly executed certification set forth on the reverse side of Optional Form WH-347 shall satisfy the requirements for submission of the "Statement of Compliance" required by subparagraph (c)(2)(ii) of this clause.
- (iv) The falsification of any of the above certifications may subject the Contractor or subcontractor to civil or criminal prosecution under Section 1001 of Title 18 and Section 3729 of Title 31 of the United States Code.
- (3) The Contractor or subcontractor shall make the records required under subparagraph (c)(1) available for inspection, copying, or transcription by authorized representatives of HUD or its designee, the Contracting Officer, or the Department of Labor and shall permit such representatives to interview employees during working hours on the job. If the Contractor or subcontractor fails to submit the required records or to make them available, HUD or its designee may, after written notice to the Contractor, take such action as may be necessary to cause the suspension of any further payment, advance, or guarantee of funds. Furthermore, failure to submit the required records upon request or to

make such records available may be grounds for debarment action pursuant to 29 CFR 5.12.

- (d) (1) Apprentices. Apprentices will be permitted to work at less than the predetermined rate for the work they performed when they are employed pursuant to and individually registered in a bona fide apprenticeship program registered with the U.S. Department of Labor, Employment and Training Administration, Office of Apprenticeship and Training, Employer and Labor Services (OATELS), or with a State Apprenticeship Agency recognized by OATELS, or if a person is employed in his or her first 90 days of probationary employment as an apprentice in such an apprenticeship program, who is not individually registered in the program, but who has been certified by OATELS or a State Apprenticeship Agency (where appropriate) to be eligible for probationary employment as an apprentice. The allowable ratio of apprentices to journeymen on the job site in any craft classification shall not be greater than the ratio permitted to the Contractor as to the entire work force under the registered program. Any worker listed on a payroll at an apprentice wage rate, who is not registered or otherwise employed as stated in this paragraph, shall be paid not less than the applicable wage rate on the wage determination for the classification of work actually performed. In addition, any apprentice performing work on the job site in excess of the ratio permitted under the registered program shall be paid not less than the applicable wage rate on the wage determination for the work actually performed. Where a contractor is performing construction on a project in a locality other than that in which its program is registered, the ratios and wage rates (expressed in percentages of the journeyman's hourly rate) specified in the Contractor's or subcontractor's registered program shall be observed. Every apprentice must be paid at not less than the rate specified in the registered program for the apprentice's level of progress, expressed as a percentage of the journeyman hourly rate specified in the applicable wage determination. Apprentices shall be paid fringe benefits in accordance with the provisions of the apprenticeship program. If the apprenticeship program does not specify fringe benefits, apprentices must be paid the full amount of fringe benefits listed on the wage determination for the applicable classification. If the Administrator of the Wage and Hour Division determines that a different practice prevails for the applicable apprentice classification, fringes shall be paid in accordance with that determination. In the event OATELS, or a State Apprenticeship Agency recognized by OATELS, withdraws approval of an apprenticeship program, the Contractor will no longer be permitted to utilize apprentices at less than the applicable predetermined rate for the work performed until an acceptable program is approved.
- (2) Trainees. Except as provided in 29 CFR 5.16, trainees will not be permitted to work at less than the predetermined rate for the work performed unless they are employed pursuant to and individually registered in a program which has received prior approval, evidenced by formal certification by the U.S. Department of Labor, Employment and Training Administration. The ratio of trainees to journeymen on the job site shall not be greater than permitted under

the plan approved by the Employment and Training Administration. Every trainee must be paid at not less than the rate specified in the approved program for the trainee's level of progress, expressed as a percentage of the journeyman hourly rate specified in the applicable wage determination. Trainees shall be paid fringe benefits in accordance with the provisions of the trainee program. If the trainee program does not mention fringe benefits, trainees shall be paid the full amount of fringe benefits listed in the wage determination unless the Administrator of the Wage and Hour Division determines that there is an apprenticeship program associated with the corresponding journeyman wage rate in the wage determination which provides for less than full fringe benefits for apprentices. Any employee listed on the payroll at a trainee rate who is not registered and participating in a training plan approved by the Employment and Training Administration shall be paid not less than the applicable wage rate in the wage determination for the classification of work actually performed. In addition, any trainee performing work on the job site in excess of the ratio permitted under the registered program shall be paid not less than the applicable wage rate in the wage determination for the work actually performed. In the event the Employment and Training Administration withdraws approval of a training program, the Contractor will no longer be permitted to utilize trainees at less than the applicable predetermined rate for the work performed until an acceptable program is approved.

- (3) Equal employment opportunity. The utilization of apprentices, trainees, and journeymen under this clause shall be in conformity with the equal employment opportunity requirements of Executive Order 11246, as amended, and 29 CFR Part 30.
- (e) Compliance with Copeland Act requirements. The Contractor shall comply with the requirements of 29 CFR Part 3, which are hereby incorporated by reference in this contract.
- (f) Contract termination; debarment. A breach of this contract clause may be grounds for termination of the contract and for debarment as a Contractor and a subcontractor as provided in 29 CFR 5.12.
- (g) Compliance with Davis-Bacon and related Act requirements. All rulings and interpretations of the Davis-Bacon and related Acts contained in 29 CFR Parts 1, 3, and 5 are herein incorporated by reference in this contract.
- (h) Disputes concerning labor standards. Disputes arising out of the labor standards provisions of this clause shall not be subject to the general disputes clause of this contract. Such disputes shall be resolved in accordance with the procedures of the Department of Labor set forth in 29 CFR Parts 5, 6, and 7. Disputes within the meaning of this clause include disputes between the Contractor (or any of its subcontractors) and the PHA, HUD, the U.S. Department of Labor, or the employees or their representatives.
- (i) Certification of eligibility.
  - (1) By entering into this contract, the Contractor certifies that neither it (nor he or she) nor any person or firm who has an interest in the Contractor's firm is a person or firm ineligible to be awarded contracts by the United States Government by virtue of section 3(a) of the Davis-Bacon Act or 29 CFR 5.12(a)(1).

- (2) No part of this contract shall be subcontracted to any person or firm ineligible for award of a United States Government contract by virtue of section 3(a) of the Davis-Bacon Act or 29 CFR 5.12(a)(1).
  - (3) The penalty for making false statements is prescribed in the U. S. Criminal Code, 18 U.S.C. 1001.
- (j) Contract Work Hours and Safety Standards Act. As used in this paragraph, the terms "laborers" and "mechanics" include watchmen and guards.
- (1) Overtime requirements. No contractor or subcontractor contracting for any part of the contract work which may require or involve the employment of laborers or mechanics, including watchmen and guards, shall require or permit any such laborer or mechanic in any workweek in which the individual is employed on such work to work in excess of 40 hours in such workweek unless such laborer or mechanic receives compensation at a rate not less than one and one-half times the basic rate of pay for all hours worked in excess of 40 hours in such workweek.
  - (2) Violation; liability for unpaid wages; liquidated damages. In the event of any violation of the provisions set forth in subparagraph (j)(1) of this clause, the Contractor and any subcontractor responsible therefor shall be liable for the unpaid wages. In addition, such Contractor and subcontractor shall be liable to the United States (in the case of work done under contract for the District of Columbia or a territory, to such District or to such territory), for liquidated damages. Such liquidated damages shall be computed with respect to each individual laborer or mechanic (including watchmen and guards) employed in violation of the provisions set forth in subparagraph (j)(1) of this clause, in the sum of \$10 for each calendar day on which such individual was required or permitted to work in excess of the standard workweek of 40 hours without payment of the overtime wages required by provisions set forth in subparagraph (j)(1) of this clause.
  - (3) Withholding for unpaid wages and liquidated damages. HUD or its designee shall upon its own action or upon written request of an authorized representative of the Department of Labor withhold or cause to be withheld, from any moneys payable on account of work performed by the Contractor or subcontractor under any such contract or any Federal contract with the same prime Contractor, or any other Federally-assisted contract subject to the Contract Work Hours and Safety Standards Act, which is held by the same prime Contractor, such sums as may be determined to be necessary to satisfy any liabilities of such Contractor or subcontractor for unpaid wages and liquidated damages as provided in the provisions set forth in subparagraph (j)(2) of this clause.
- (k) Subcontracts. The Contractor or subcontractor shall insert in any subcontracts all the provisions contained in this clause, and such other clauses as HUD or its designee may by appropriate instructions require, and also a clause requiring the subcontractors to include these provisions in any lower tier subcontracts. The prime Contractor shall be responsible for the compliance by any subcontractor or lower tier subcontractor with all these provisions.



**Requirements for Compliance with Requirements of Section 3 of the Housing and Urban Development Act of 1968 (12 U.S.C. 1701u) (Section 3) Part 135 - Economic Opportunities for Low- and Very Low-Income Persons.**

**Purpose:** The purpose of Section 3 of the Housing and Urban Development of 1968 (12 U.S.C. 1701u) (Section 3) is to ensure that employment and other economic and business opportunities generated by HUD Financial Assistance shall be directed to Housing Authority Residents and other low- and very low-income persons, particularly those who are recipients of government housing assistance and to business concerns which provide economic opportunities to Guam Housing and Urban Renewal Authority (GHURA) Residents and other low- and very low-income persons.

**General Policy Statement:** It is the declared policy of GHURA that Equal Employment Opportunities shall be provided for every employee and applicant for employment regardless of race, color, religion, sex, national origin, handicap, or economic status; and, that through the award of contracts to contractors, vendors, and suppliers, that employment and business opportunities be created for residents of GHURA properties and other qualified low- and very low-income persons residing on the island of Guam. This policy does not end with the mere prohibition of discriminatory practices by programs receiving HUD financial assistance or contractors, subcontractors, and vendors contracting with GHURA. GHURA recognizes its obligation as well as the obligation of potential contractors, subcontractors, and vendors, to develop practical steps to achieve the goal of providing meaningful, full-time permanent employment opportunities, as well as business opportunities to GHURA Residents and other Section 3 eligible persons.

Such obligation shall be demonstrated not merely through inclusion of positive or “best effort” steps, but shall result in a reasonable level of success in the recruitment, employment, and utilization of GHURA Residents and other Section 3 eligible persons and businesses in the workforce and subcontracting of work resulting out of the expenditure of HUD funding. GHURA’s Board of Commission, through official resolution, shall examine and consider a contractor/vendor’s success in providing employment and business opportunities to Authority Residents prior to acting on any proposed contract award.

**Numerical Goals for Section 3 Compliance:** Consistent with 24 CFR 85.36 (c)(2), Section 3 is a federal statute that expressly encourages, to the maximum extent feasible, a geographic preference in the evaluation of bids or proposals. To that end, GHURA has adopted the following numerical goals for meeting the greatest extent feasible requirement to provide economic opportunities to Section 3 Residents and Section 3 Business Concerns in the procurement and awarding of modernization-funded construction and professional service contracts:

**Numerical Goals for Section 3 Compliance**

Areas of Focus (Applies to all contracts)	Numerical Goal
Contractor and Sub-contractor Hiring (full-time, part-time, temporary, seasonal) applies to construction and professional service contracts.	30%
Contract Awards (applies to construction contracts.	30%
ALL Other Contract Awards (i.e., services, supplies, professional services)	30%

Recipients and Contractors may demonstrate compliance with the “greatest extent feasible” requirement of Section 3 by meeting the numerical goals set forth in this Section 3 Program for providing training, employment, and contracting opportunities to Section 3 Residents and Section Business Concerns. Efforts to employ Section 3 Residents to the greatest extent feasible should be made at all job levels.

GHURA, in its own operations, shall endeavor to achieve the goals of Section 3 and shall provide equal responsibility to its contractors, vendors, and suppliers to implement progressive efforts to also attain compliance. In doing so, GHURA shall evaluate contractors' compliance towards achieving the goals of Section 3 and ensure a system of leveling sanctions against contractor, vendor, or supplier for non-compliance and endeavor to take appropriate steps to ensure any such concern is not permitted to participate in future GHURA procurement activities.

The numerical goals established above represent minimum numerical targets and all prospective contractors shall be advised and encouraged to seek Section 3 participation to the greatest extent feasible. Any contractor that meets the minimum numerical goals set forth above will be considered to have complied with the Section 3 requirements. Any contractor that does not meet the numerical goals set forth above has the burden of demonstrating why it was not feasible to meet the numerical goals. In the event no competing contractors were successful in meeting the minimum goals set forth above, GHURA shall consider documentation provided by the contractor evidencing impediments encountered despite actions taken to comply with the Section 3 Requirements. Such evidence shall be subject to the satisfaction of GHURA. Any contractor found to be in non-compliance with Section 3 shall be considered ineligible for award.

All contractors submitting bids/proposals to the GHURA shall be required to complete certifications, as appropriate, as acknowledgment of the Section 3 contracting and employment provisions as required by this section. Such certifications shall be supported with adequate evidence to support representations made. The certifications required to be submitted with the bid/proposal consist of the following:

- Certification for business concerns seeking Section 3 preference.
- Contractor certification of efforts to fully comply with employment and training provisions of Section 3.

Prior to the award of any contract the contractor shall enter into negotiations with GHURA for the purpose of incorporating into the contract a provision for a specific number of Public Housing residents or other Section 3 residents to be trained or employed on the contract. Such resulting provision shall obligate the contractor toward achieving not less than the numerical goals listed above and shall be based on a detailed workforce analysis to be compiled by the contractor and submitted to GHURA prior to award of contract.

#### **Definitions:**

**Applicant** means any entity which makes an application for section 3 covered assistance, and includes, but is not limited to, any, unit of local government, public housing agency, Indian GHURA, Indian tribe, or other public body, public or private nonprofit organization, private agency or institution, mortgagor, developer, limited dividend sponsor, builder, property manager, community housing development organization (CHDO), resident management corporation, resident council, or cooperative association.

**Contractor** means any entity which contracts to perform work generated by the expenditure of section 3 covered assistance, or for work in connection with a section 3 covered project.

**Department or HUD** means the Department of Housing and Urban Development, including its Field Offices to which authority has been delegated to perform functions under this part.

**Employment opportunities** generated by section 3 covered assistance means all employment opportunities generated by the expenditure of section 3 covered public and Indian housing assistance (i.e., operating assistance, development assistance and modernization assistance, as described in § 135.3(a)(1)).

**Housing development** means low-income housing owned, developed, or operated by public housing agencies or Indian housing authorities in accordance with HUD's public and Indian housing program regulations codified in 24 CFR Chapter IX.

**HUD Youth build** programs means programs that receive assistance under subtitle D of Title IV of the National Affordable Housing Act, as amended by the Housing and Community Development Act of 1992 (42 U.S.C. 12699), and provide disadvantaged youth with opportunities of employment, education, leadership

development, and training in the construction or rehabilitation of housing for homeless individuals and members of low- and very low-income families.

**JTPA** means the Job Training Partnership Act (29 U.S.C. 1579(a)).

**Metropolitan area** means a metropolitan statistical area (MSA), as established by the Office of Management and Budget.

**New hires** means full-time employees for permanent, temporary or seasonal employment opportunities.

**Other HUD programs** means HUD programs, other than HUD public and Indian housing programs, that provide housing and community development assistance for "section 3 covered projects," as defined in this section.

**Public housing resident** has the meaning given this term in 24 CFR part 963.

**Recipient** means any entity which receives section 3 covered assistance, directly from HUD or from another recipient and includes, but is not limited to, any State, unit of local government, PHA, IHA, Indian tribe, or other public body, public or private nonprofit organization, private agency or institution, mortgagor, developer, limited dividend sponsor, builder, property manager, community housing development organization, resident management corporation, resident council, or cooperative association.

**Section 3** means section 3 of the Housing and Urban Development Act of 1968, as amended (12 U.S.C. 1701u).

**Section 3 business concern** means a business concern, as defined in this section:

- (1) That is 51 percent or more owned by section 3 residents; or
- (2) Whose permanent, full-time employees include persons, at least 30 percent of whom are currently section 3 residents, or within three years of the date of first employment with the business concern were section 3 residents; or
- (3) That provides evidence of a commitment to subcontract in excess of 25 percent of the dollar award of all subcontracts to be awarded to business concerns that meet the qualifications set forth in paragraphs (1) or (2) in this definition of "section 3 business concern."

**Section 3 covered activity** means any activity which is funded by section 3 covered assistance and Indian housing assistance.

**Section 3 covered assistance** means:

- (1) Public and Indian housing development assistance provided pursuant to section 5 of the 1937 Act;
- (2) Public and Indian housing operating assistance provided pursuant to section 9 of the 1937 Act;
- (3) Public and Indian housing modernization assistance provided pursuant to section 14 of the 1937 Act.

**Section 3 covered contract** means a contract or subcontract (including a professional service contract) awarded by a recipient or contractor for work generated by the expenditure of section 3 covered assistance, or for work arising in connection with a section 3 covered project.

**Section 3 covered project** means the construction, reconstruction, conversion, rehabilitation of housing (including reduction and abatement of lead-based paint hazards), other public construction which includes buildings or improvements (regardless of ownership) assisted with housing or community development assistance.

**Section 3 resident** means:

- (1) A public housing resident; or
- (2) An individual who resides in the metropolitan area or non-metropolitan county in which the section 3 covered assistance is expended, and who is:
  - (1) A low-income person, as this term is defined in section 3(b)(2) of the 1937 Act (42 U.S.C. 1437a(b)(2)).

- Section 3(b)(2) of the 1937 Act defines this term to mean families (including single persons) whose incomes do not exceed 80% of the median income for the area, as determined by the Secretary, with adjustments for smaller and larger families, except that the Secretary may establish income ceilings higher or lower than 80% of the median for the area on the basis of the Secretary's findings that such variations are necessary because of prevailing levels of construction costs or unusually high or low-income families; or
- (ii) A very low-income person, as this term is defined in section 3(b)(2) of the 1937 Act (42 U.S.C. 1437a(b)(2)). Section 3(b)(2) of the 1937 Act (42 U.S.C. 1437a(b)(2) defines this term to mean families (including single persons) whose incomes do not exceed 50% of the median family income for the area, as determined by the Secretary with adjustments made for smaller or larger families, except that the Secretary may establish income ceilings higher or lower than 50% of the median for the area on the basis of the Secretary's findings that such variations are necessary because of unusually high or low family incomes.
- (3) A person seeking the training and employment preference provided by section 3 bears the responsibility of providing evidence (if requested) that the person is eligible for the preference.

**Service area** means the geographical area in which the persons benefitting from the section 3 covered project reside.

**Subcontractor** means any entity (other than a person who is an employee of the contractor) which has a contract with a contractor to undertake a portion of the contractor's obligation for the performance of work generated by the expenditure of section covered assistance, or arising in connection with a section 3 covered project.

**Section 3 joint venture** means an association of business concerns, one of which qualifies as a section 3 business concern, formed by written joint venture agreement to engage in and carry out a specific business venture for which purpose the business concerns combine their efforts, resources, and skills for joint profit, but not necessarily on a continuing or permanent basis for conducting business generally, and for which the section 3 business concern:

- (1) Is responsible for a clearly defined portion of the work to be performed and holds management responsibilities in the joint venture; and
- (2) Performs at least 25% of the work and is contractually entitled to compensation proportionate to its work.

**Preference for Section 3 Business Concerns (Contracting).** GHURA in accordance with Section 3 of the Housing and Urban Development Act of 1968, requires contractors and sub-contractors (including professional service contracts) to direct their efforts towards awarding contracts to Section 3 business concerns in the following order of priority and expend greatest extent feasible efforts to achieve, at minimum, the numerical goals established in this section:

- **1st Priority - Category 1 Section 3 Businesses**  
Business concerns that are 51% or more owned by residents of the housing development(s) for which work is performed, or whose full-time, permanent workforce includes 30% of these persons as employees.
- **2nd Priority - Category 2 Section 3 Businesses**  
Business concerns that are 51% or more owned by residents of outside development. GHURA Public Housing developments other than the development(s) where the work is performed or whose full-time permanent workforce includes 30% of these persons s employees.
- **3rd Priority - Category 3 Section 3 Businesses**  
Business concerns that are designated HUD Youth build programs.
- **4th Priority - Category 4 Section 3 Businesses**  
Business concerns that are 51% or more owned by a Section 3 resident(s), or whose permanent, full-time workforce includes no less than 30% Section 3 residents (category 4 businesses), or that subcontract in excess of 25% of the total amount of sub-contracts to Section 3 business concerns. *Under this category, the bidder must submit clear document and certifications for the qualification claimed.*

**Preference for Section 3 Residents (Employment & Training)** GHURA, in accordance with Section 3 of the Housing and Urban Development Act of 1968, requires contractors and sub-contractors (including professional service contracts) to direct their efforts toward providing training and employment opportunities to Section 3 residents in the following order of priority and expend greatest extent feasible efforts to achieve at minimum, the numerical goals established in

this section:

- **1st Priority - Category 1 Section 3 Residents**  
Residents of the development for which work is performed.
- **2nd Priority - Category 2 Section 3 Residents**  
Residents of other Public Housing developments outside of the development(s) where the work is performed.
- **3rd Priority - Category 3 Section 3 Residents**  
Residents of Guam who are participants in HUD Youthbuild programs.
- **4th Priority - Category 4 Section 3 Residents**  
Other Section 3 Residents.

**Certification Procedure.** GHURA has its own program of self-certification for individuals and business concerns seeking recognition as a Section 3 resident or Section 3 business concern as defined in this Section 3 Program. GHURA's Resident & Community Services department is charged with administering GHURA's Section 3 certification program. Any individual or business concern seeking Section 3 preferences in the awarding of contracts or purchase agreements shall complete appropriate certification forms and provide adequate documentation as evidence of eligibility for preference under the Section 3 program. An individual or business concern may apply for certification as a Section 3 resident or Section 3 business concern either prior to bidding for Authority work or during the actual bidding process. Any business concern that submits certification for preference after receipt of bid will not be considered eligible for Section 3 preference in the evaluation of that specific bid award. Certifications for Section 3 preference for business concerns must be received by GHURA prior to the submission of bids or along with the bid. Certifications for eligibility as a Section 3 resident may be made at any time. Individuals or business concerns seeking to file for Section 3 preference shall contact:

- A resident seeking preference in training and employment shall certify that he/she is a Section 3 resident by completing the appropriate certification form and attaching adequate proof of Section 3 eligibility.
- A business concern seeking preference in the awarding of a contract or purchase shall certify that the business concern is a Section 3 business by completing the appropriate certification form and attaching adequate proof of Section 3 eligibility as required.

**Protest Procedure.** GHURA desires to offer to concerned parties a procedure whereby complaints alleging non-compliance with the Section 3 Statute can receive prompt and equitable hearing and resolution. Protests surrounding GHURA's Section 3 program may be submitted in writing to the following person hereby designated as the Section 3 Coordinator:

All complaints of non-compliance with the Section 3 Statute shall conform with the following requirements:

- Complaints shall be filed in writing and shall contain the name, address, and phone number of the person filing the complaint, and a brief description of the alleged violation of the regulations.
- Complaints shall be filed within thirty (30) calendar days after the complainant becomes aware of the alleged violation.
- An investigation as may be appropriate, will follow the filing of a complaint. The investigation will be conducted by GHURA's Section 3 Coordinator. These rules contemplate informal, but thorough investigations, affording all interested persons and their representatives, if any, an opportunity to submit testimony and/or evidence as may be available and relevant to the complaint.
- Written documentation as to the validity of the complaint and a description of the findings or resolution, if any, will be issued by the Section 3 Coordinator no later than thirty (30) days after the filing of a complaint.

In cases where concerned parties wish to have its complaint considered outside of GHURA, a complaint may be filed with the Assistant Secretary for Fair Housing and Equal Opportunity, Department of Housing and Urban Development, Washington, D.C., 20410. A complaint must be received not later than 180 days from the date of the action or omission upon which the complaints based, unless the time for filing is extended by the Assistant Secretary for good cause shown.

## **Contractor Certification of Efforts to Fully Comply with Employment and Training Provisions of Section 3**

### **The bidder represents and certifies as part of its bid/offer the following:**

- Is a Section 3 Business concern and has submitted the required certification with the bid. A Section 3 Business concern means a business concern:
  1. That is 51% or more owned by Section 3 Resident(s); or
  2. Whose permanent, full-time employees include persons, at least 30% of whom are currently Section 3 residents, or within the last three years of the date of first employment with the business concern were Section 3 residents; or
  3. That provides evidence of a commitment to subcontract in excess of 25% of the dollar value of all subcontracts to be awarded to business concerns that meet the qualifications set forth in paragraphs 1 or 2 herein.
- Is Not a Section 3 Business concern but who has and will continue to seek compliance with Section 3 by certifying to the following efforts to be undertaken.

### **Efforts to award subcontractor to Section 3 concerns (check all that apply.)**

- By contacting business assistance agencies, minority contractor's associations and community organizations to inform them of the contracting opportunities and requesting their assistance in identifying Section 3 businesses which may solicit bids for a portion of the work.
- By advertising contracting opportunities by posting notices, which provide general information about the work to be contracted and where to obtain additional information, in the common areas of the applicable development(s) owned and managed by the Housing Authority.
- By providing written notice to all known Section 3 business concerns of contracting opportunities. This notice should be in sufficient time to allow the Section 3 business concerns to respond to bid invitations
- By following up with Section 3 business concerns that have expressed interest in the contracting opportunities
- By coordinating meetings at which Section 3 business concerns could be informed of specific elements of the work for which subcontract bids are being sought
- By conducting workshops on contracting procedures and specific contracting opportunities in a timely manner so that Section 3 business concerns can take advantage of contracting opportunities
- By advising Section 3 business concerns as to where they may seek assistance to overcome barriers such as inability to obtain bonding, lines of credit, financing, or insurance, and aiding Section 3 businesses in qualifying for such bonding, financing, insurance, etc.
- Where appropriate, by breaking out contract work into economically feasible units to facilitate participation by Section 3 businesses
- By developing and utilizing a list of eligible Section 3 business concerns
- By actively supporting and undertaking joint ventures with Section 3 businesses

### **Efforts to provide training and employment to section 3 residents**

- By entering into a "first source" hiring agreements with organizations representing Section 3 residents
- By establishing training programs, which are consistent with the requirements of the Department of Labor,

specifically for Section 3 residents in the building trades

- By advertising employment and training positions to dwelling units occupied by Category 1 and 2 residents
- By contacting resident councils and other resident organizations in the affected housing development to request assistance in notifying residents of the training and employment positions to be filled
- By arranging interviews and conducting interviews on the job site
- By undertaking such continued job training efforts as may be necessary to ensure the continued employment of Section 3 residents previously hired for employment opportunities.

Name: \_\_\_\_\_

Name: \_\_\_\_\_

Signature: \_\_\_\_\_

Signature: \_\_\_\_\_

Title: \_\_\_\_\_  
Bidder/offeror, if the Bidder/offeror is an  
Individual Partner, if the Bidder/offeror is a  
Partnership Officer, if the Bidder/offeror is a  
Corporation

Title: \_\_\_\_\_  
Bidder/offeror, if the Bidder/offeror is an  
Individual Partner, if the Bidder/offeror is a  
Partnership Officer, if the Bidder/offeror is a  
Corporation

Company Name: \_\_\_\_\_

Company Name: \_\_\_\_\_

Date: \_\_\_\_\_

Date: \_\_\_\_\_

Subscribed and sworn to before me \_\_\_\_\_

This \_\_\_\_\_ day of \_\_\_\_\_, 20 \_\_\_\_.

My Commission expires \_\_\_\_\_, 20 \_\_\_\_

"General Decision Number: GU20210001 01/01/2021

Superseded General Decision Number: GU20200001

State: Guam

Construction Types: Building, Heavy, Highway and Residential

Excludes any projects funded under the National Defense Authorization Act 2010 - Guam Realignment Fund - Defense Policy Review

County: Guam Statewide.

BUILDING, HEAVY, HIGHWAY AND RESIDENTIAL

Note: Under Executive Order (EO) 13658, an hourly minimum wage of \$10.95 for calendar year 2021 applies to all contracts subject to the Davis-Bacon Act for which the contract is awarded (and any solicitation was issued) on or after January 1, 2015. If this contract is covered by the EO, the contractor must pay all workers in any classification listed on this wage determination at least \$10.95 per hour (or the applicable wage rate listed on this wage determination, if it is higher) for all hours spent performing on the contract in calendar year 2021. If this contract is covered by the EO and a classification considered necessary for performance of work on the contract does not appear on this wage determination, the contractor must pay workers in that classification at least the wage rate determined through the conformance process set forth in 29 CFR 5.5(a)(1)(ii) (or the EO minimum wage rate, if it is higher than the conformed wage rate). The EO minimum wage rate will be adjusted annually. Please note that this EO applies to the above-mentioned types of contracts entered into by the federal government that are subject to the Davis-Bacon Act itself, but it does not apply to contracts subject only to the Davis-Bacon Related Acts, including those set forth at 29 CFR 5.1(a)(2)-(60). Additional information on contractor requirements and worker protections under the EO is available at [www.dol.gov/whd/govcontracts](http://www.dol.gov/whd/govcontracts).

Modification Number	Publication Date
0	01/01/2021

SUGU2020-001 03/05/2020

	Rates	Fringes
CARPENTER.....	\$ 15.48	
CEMENT MASON.....	\$ 14.92	
ELECTRICIAN.....	\$ 18.52	
Heavy Equipment Mechanic.....	\$ 18.32	
Heavy Equipment Operator.....	\$ 16.58	
IRONWORKER, REINFORCING.....	\$ 15.61	



IRONWORKER, STRUCTURAL.....\$ 14.90  
 PAINTER.....\$ 12.86  
 PIPEFITTER.....\$ 16.52  
 PLASTERER.....\$ 22.89  
 PLUMBER.....\$ 16.52  
 REFRIGERATION MECHANIC  
 (including Heating, Air  
 Conditioning (HVAC) Mechanic  
 work).....\$ 18.43  
 SHEET METAL WORKER.....\$ 16.73

-----  
 WELDERS - Receive rate prescribed for craft performing  
 operation to which welding is incidental.

=====  
 Note: Executive Order (EO) 13706, Establishing Paid Sick Leave  
 for Federal Contractors applies to all contracts subject to the  
 Davis-Bacon Act for which the contract is awarded (and any  
 solicitation was issued) on or after January 1, 2017. If this  
 contract is covered by the EO, the contractor must provide  
 employees with 1 hour of paid sick leave for every 30 hours  
 they work, up to 56 hours of paid sick leave each year.  
 Employees must be permitted to use paid sick leave for their  
 own illness, injury or other health-related needs, including  
 preventive care; to assist a family member (or person who is  
 like family to the employee) who is ill, injured, or has other  
 health-related needs, including preventive care; or for reasons  
 resulting from, or to assist a family member (or person who is  
 like family to the employee) who is a victim of, domestic  
 violence, sexual assault, or stalking. Additional information  
 on contractor requirements and worker protections under the EO  
 is available at [www.dol.gov/whd/govcontracts](http://www.dol.gov/whd/govcontracts).

Unlisted classifications needed for work not included within  
 the scope of the classifications listed may be added after  
 award only as provided in the labor standards contract clauses  
 (29CFR 5.5 (a) (1) (ii)).

-----  
 The body of each wage determination lists the classification  
 and wage rates that have been found to be prevailing for the  
 cited type(s) of construction in the area covered by the wage  
 determination. The classifications are listed in alphabetical  
 order of ""identifiers"" that indicate whether the particular  
 rate is a union rate (current union negotiated rate for local),  
 a survey rate (weighted average rate) or a union average rate  
 (weighted union average rate).

Union Rate Identifiers

A four letter classification abbreviation identifier enclosed  
 in dotted lines beginning with characters other than ""SU"" or  
 ""UAVG"" denotes that the union classification and rate were  
 prevailing for that classification in the survey. Example:

PLUM0198-005 07/01/2014. PLUM is an abbreviation identifier of the union which prevailed in the survey for this classification, which in this example would be Plumbers. 0198 indicates the local union number or district council number where applicable, i.e., Plumbers Local 0198. The next number, 005 in the example, is an internal number used in processing the wage determination. 07/01/2014 is the effective date of the most current negotiated rate, which in this example is July 1, 2014.

Union prevailing wage rates are updated to reflect all rate changes in the collective bargaining agreement (CBA) governing this classification and rate.

#### Survey Rate Identifiers

Classifications listed under the "SU" identifier indicate that no one rate prevailed for this classification in the survey and the published rate is derived by computing a weighted average rate based on all the rates reported in the survey for that classification. As this weighted average rate includes all rates reported in the survey, it may include both union and non-union rates. Example: SULA2012-007 5/13/2014. SU indicates the rates are survey rates based on a weighted average calculation of rates and are not majority rates. LA indicates the State of Louisiana. 2012 is the year of survey on which these classifications and rates are based. The next number, 007 in the example, is an internal number used in producing the wage determination. 5/13/2014 indicates the survey completion date for the classifications and rates under that identifier.

Survey wage rates are not updated and remain in effect until a new survey is conducted.

#### Union Average Rate Identifiers

Classification(s) listed under the UAVG identifier indicate that no single majority rate prevailed for those classifications; however, 100% of the data reported for the classifications was union data. EXAMPLE: UAVG-OH-0010 08/29/2014. UAVG indicates that the rate is a weighted union average rate. OH indicates the state. The next number, 0010 in the example, is an internal number used in producing the wage determination. 08/29/2014 indicates the survey completion date for the classifications and rates under that identifier.

A UAVG rate will be updated once a year, usually in January of each year, to reflect a weighted average of the current negotiated/CBA rate of the union locals from which the rate is based.

---

#### WAGE DETERMINATION APPEALS PROCESS

1.) Has there been an initial decision in the matter? This can be:

- \* an existing published wage determination
- \* a survey underlying a wage determination
- \* a Wage and Hour Division letter setting forth a position on a wage determination matter
- \* a conformance (additional classification and rate) ruling

On survey related matters, initial contact, including requests for summaries of surveys, should be with the Wage and Hour Regional Office for the area in which the survey was conducted because those Regional Offices have responsibility for the Davis-Bacon survey program. If the response from this initial contact is not satisfactory, then the process described in 2.) and 3.) should be followed.

With regard to any other matter not yet ripe for the formal process described here, initial contact should be with the Branch of Construction Wage Determinations. Write to:

Branch of Construction Wage Determinations  
Wage and Hour Division  
U.S. Department of Labor  
200 Constitution Avenue, N.W.  
Washington, DC 20210

2.) If the answer to the question in 1.) is yes, then an interested party (those affected by the action) can request review and reconsideration from the Wage and Hour Administrator (See 29 CFR Part 1.8 and 29 CFR Part 7). Write to:

Wage and Hour Administrator  
U.S. Department of Labor  
200 Constitution Avenue, N.W.  
Washington, DC 20210

The request should be accompanied by a full statement of the interested party's position and by any information (wage payment data, project description, area practice material, etc.) that the requestor considers relevant to the issue.

3.) If the decision of the Administrator is not favorable, an interested party may appeal directly to the Administrative Review Board (formerly the Wage Appeals Board). Write to:

Administrative Review Board  
U.S. Department of Labor  
200 Constitution Avenue, N.W.  
Washington, DC 20210

4.) All decisions by the Administrative Review Board are final.

=====

END OF GENERAL DECISION

"

## Applicability

The Project or Program to which the construction work covered by this contract pertains is being assisted by the United States of America and the following Federal Labor Standards Provisions are included in this Contract pursuant to the provisions applicable to such Federal assistance.

**A. 1. (i) Minimum Wages.** All laborers and mechanics employed or working upon the site of the work, will be paid unconditionally and not less often than once a week, and without subsequent deduction or rebate on any account (except such payroll deductions as are permitted by regulations issued by the Secretary of Labor under the Copeland Act (29 CFR Part 3), the full amount of wages and bona fide fringe benefits (or cash equivalents thereof) due at time of payment computed at rates not less than those contained in the wage determination of the Secretary of Labor which is attached hereto and made a part hereof, regardless of any contractual relationship which may be alleged to exist between the contractor and such laborers and mechanics. Contributions made or costs reasonably anticipated for bona fide fringe benefits under Section I(b)(2) of the Davis-Bacon Act on behalf of laborers or mechanics are considered wages paid to such laborers or mechanics, subject to the provisions of 29 CFR 5.5(a)(1)(iv); also, regular contributions made or costs incurred for more than a weekly period (but not less often than quarterly) under plans, funds, or programs, which cover the particular weekly period, are deemed to be constructively made or incurred during such weekly period. Such laborers and mechanics shall be paid the appropriate wage rate and fringe benefits on the wage determination for the classification of work actually performed, without regard to skill, except as provided in 29 CFR 5.5(a)(4). Laborers or mechanics performing work in more than one classification may be compensated at the rate specified for each classification for the time actually worked therein: Provided, That the employer's payroll records accurately set forth the time spent in each classification in which work is performed. The wage determination (including any additional classification and wage rates conformed under 29 CFR 5.5(a)(1)(ii) and the Davis-Bacon poster (WH-1321) shall be posted at all times by the contractor and its subcontractors at the site of the work in a prominent and accessible, place where it can be easily seen by the workers.

**(ii) (a)** Any class of laborers or mechanics which is not listed in the wage determination and which is to be employed under the contract shall be classified in conformance with the wage determination. HUD shall approve an additional classification and wage rate and fringe benefits therefor only when the following criteria have been met:

**(1)** The work to be performed by the classification requested is not performed by a classification in the wage determination; and

**(2)** The classification is utilized in the area by the construction industry; and

**(3)** The proposed wage rate, including any bona fide fringe benefits, bears a reasonable relationship to the wage rates contained in the wage determination.

**(b)** If the contractor and the laborers and mechanics to be employed in the classification (if known), or their representatives, and HUD or its designee agree on the classification and wage rate (including the amount designated for fringe benefits where appropriate), a report of the action taken shall be sent by HUD or its designee to the Administrator of the Wage and Hour Division, Employment Standards Administration, U.S. Department of Labor, Washington, D.C. 20210. The Administrator, or an authorized representative, will approve, modify, or disapprove every additional classification action within 30 days of receipt and so advise HUD or its designee or will notify HUD or its designee within the 30-day period that additional time is necessary. (Approved by the Office of Management and Budget under OMB control number 1215-0140.)

**(c)** In the event the contractor, the laborers or mechanics to be employed in the classification or their representatives, and HUD or its designee do not agree on the proposed classification and wage rate (including the amount designated for fringe benefits, where appropriate), HUD or its designee shall refer the questions, including the views of all interested parties and the recommendation of HUD or its designee, to the Administrator for determination. The Administrator, or an authorized representative, will issue a determination within 30 days of receipt and so advise HUD or its designee or will notify HUD or its designee within the 30-day period that additional time is necessary. (Approved by the Office of Management and Budget under OMB Control Number 1215-0140.)

**(d)** The wage rate (including fringe benefits where appropriate) determined pursuant to subparagraphs (1)(ii)(b) or (c) of this paragraph, shall be paid to all workers performing work in the classification under this contract from the first day on which work is performed in the classification.

**(iii)** Whenever the minimum wage rate prescribed in the contract for a class of laborers or mechanics includes a fringe benefit which is not expressed as an hourly rate, the contractor shall either pay the benefit as stated in the wage determination or shall pay another bona fide fringe benefit or an hourly cash equivalent thereof.

**(iv)** If the contractor does not make payments to a trustee or other third person, the contractor may consider as part

of the wages of any laborer or mechanic the amount of any costs reasonably anticipated in providing bona fide fringe benefits under a plan or program, Provided, That the Secretary of Labor has found, upon the written request of the contractor, that the applicable standards of the Davis-Bacon Act have been met. The Secretary of Labor may require the contractor to set aside in a separate account assets for the meeting of obligations under the plan or program. (Approved by the Office of Management and Budget under OMB Control Number 1215-0140.)

**2. Withholding.** HUD or its designee shall upon its own action or upon written request of an authorized representative of the Department of Labor withhold or cause to be withheld from the contractor under this contract or any other Federal contract with the same prime contractor, or any other Federally-assisted contract subject to Davis-Bacon prevailing wage requirements, which is held by the same prime contractor so much of the accrued payments or advances as may be considered necessary to pay laborers and mechanics, including apprentices, trainees and helpers, employed by the contractor or any subcontractor the full amount of wages required by the contract. In the event of failure to pay any laborer or mechanic, including any apprentice, trainee or helper, employed or working on the site of the work, all or part of the wages required by the contract, HUD or its designee may, after written notice to the contractor, sponsor, applicant, or owner, take such action as may be necessary to cause the suspension of any further payment, advance, or guarantee of funds until such violations have ceased. HUD or its designee may, after written notice to the contractor, disburse such amounts withheld for and on account of the contractor or subcontractor to the respective employees to whom they are due. The Comptroller General shall make such disbursements in the case of direct Davis-Bacon Act contracts.

**3. (i) Payrolls and basic records.** Payrolls and basic records relating thereto shall be maintained by the contractor during the course of the work preserved for a period of three years thereafter for all laborers and mechanics working at the site of the work. Such records shall contain the name, address, and social security number of each such worker, his or her correct classification, hourly rates of wages paid (including rates of contributions or costs anticipated for bona fide fringe benefits or cash equivalents thereof of the types described in Section 1(b)(2)(B) of the Davis-bacon Act), daily and weekly number of hours worked, deductions made and actual wages paid. Whenever the Secretary of Labor has found under 29 CFR 5.5 (a)(1)(iv) that the wages of any laborer or mechanic include the amount of any costs reasonably anticipated in providing benefits under a plan or program described in Section 1(b)(2)(B) of the Davis-Bacon Act, the contractor shall maintain records which show that the commitment to provide such benefits is enforceable, that the plan or program is financially responsible, and that the plan or program has been

communicated in writing to the laborers or mechanics affected, and records which show the costs anticipated or the actual cost incurred in providing such benefits. Contractors employing apprentices or trainees under approved programs shall maintain written evidence of the registration of apprenticeship programs and certification of trainee programs, the registration of the apprentices and trainees, and the ratios and wage rates prescribed in the applicable programs. (Approved by the Office of Management and Budget under OMB Control Numbers 1215-0140 and 1215-0017.)

**(ii) (a)** The contractor shall submit weekly for each week in which any contract work is performed a copy of all payrolls to HUD or its designee if the agency is a party to the contract, but if the agency is not such a party, the contractor will submit the payrolls to the applicant sponsor, or owner, as the case may be, for transmission to HUD or its designee. The payrolls submitted shall set out accurately and completely all of the information required to be maintained under 29 CFR 5.5(a)(3)(i) except that full social security numbers and home addresses shall not be included on weekly transmittals. Instead the payrolls shall only need to include an individually identifying number for each employee (e.g., the last four digits of the employee's social security number). The required weekly payroll information may be submitted in any form desired. Optional Form WH-347 is available for this purpose from the Wage and Hour Division Web site at <http://www.dol.gov/esa/whd/forms/wh347instr.htm> or its successor site. The prime contractor is responsible for the submission of copies of payrolls by all subcontractors. Contractors and subcontractors shall maintain the full social security number and current address of each covered worker, and shall provide them upon request to HUD or its designee if the agency is a party to the contract, but if the agency is not such a party, the contractor will submit the payrolls to the applicant sponsor, or owner, as the case may be, for transmission to HUD or its designee, the contractor, or the Wage and Hour Division of the Department of Labor for purposes of an investigation or audit of compliance with prevailing wage requirements. It is not a violation of this subparagraph for a prime contractor to require a subcontractor to provide addresses and social security numbers to the prime contractor for its own records, without weekly submission to HUD or its designee. (Approved by the Office of Management and Budget under OMB Control Number 1215-0149.)

**(b)** Each payroll submitted shall be accompanied by a "Statement of Compliance," signed by the contractor or subcontractor or his or her agent who pays or supervises the payment of the persons employed under the contract and shall certify the following:

**(1)** That the payroll for the payroll period contains the information required to be provided under 29 CFR 5.5 (a)(3)(ii), the appropriate information is being maintained under 29 CFR 5.5(a)(3)(i), and that such information is correct and complete;

(2) That each laborer or mechanic (including each helper, apprentice, and trainee) employed on the contract during the payroll period has been paid the full weekly wages earned, without rebate, either directly or indirectly, and that no deductions have been made either directly or indirectly from the full wages earned, other than permissible deductions as set forth in 29 CFR Part 3;

(3) That each laborer or mechanic has been paid not less than the applicable wage rates and fringe benefits or cash equivalents for the classification of work performed, as specified in the applicable wage determination incorporated into the contract.

(c) The weekly submission of a properly executed certification set forth on the reverse side of Optional Form WH-347 shall satisfy the requirement for submission of the "Statement of Compliance" required by subparagraph A.3.(ii)(b).

(d) The falsification of any of the above certifications may subject the contractor or subcontractor to civil or criminal prosecution under Section 1001 of Title 18 and Section 231 of Title 31 of the United States Code.

(iii) The contractor or subcontractor shall make the records required under subparagraph A.3.(i) available for inspection, copying, or transcription by authorized representatives of HUD or its designee or the Department of Labor, and shall permit such representatives to interview employees during working hours on the job. If the contractor or subcontractor fails to submit the required records or to make them available, HUD or its designee may, after written notice to the contractor, sponsor, applicant or owner, take such action as may be necessary to cause the suspension of any further payment, advance, or guarantee of funds. Furthermore, failure to submit the required records upon request or to make such records available may be grounds for debarment action pursuant to 29 CFR 5.12.

#### 4. Apprentices and Trainees.

(i) **Apprentices.** Apprentices will be permitted to work at less than the predetermined rate for the work they performed when they are employed pursuant to and individually registered in a bona fide apprenticeship program registered with the U.S. Department of Labor, Employment and Training Administration, Office of Apprenticeship Training, Employer and Labor Services, or with a State Apprenticeship Agency recognized by the Office, or if a person is employed in his or her first 90 days of probationary employment as an apprentice in such an apprenticeship program, who is not individually registered in the program, but who has been certified by the Office of Apprenticeship Training, Employer and Labor Services or a State Apprenticeship Agency (where appropriate) to be eligible for probationary employment as an apprentice. The allowable ratio of apprentices to journeymen on the job site in any craft classification shall not be greater than the ratio permitted to the contractor as to the entire work force under the registered program. Any worker listed on a payroll at an apprentice wage rate, who

is not registered or otherwise employed as stated above, shall be paid not less than the applicable wage rate on the wage determination for the classification of work actually performed. In addition, any apprentice performing work on the job site in excess of the ratio permitted under the registered program shall be paid not less than the applicable wage rate on the wage determination for the work actually performed. Where a contractor is performing construction on a project in a locality other than that in which its program is registered, the ratios and wage rates (expressed in percentages of the journeyman's hourly rate) specified in the contractor's or subcontractor's registered program shall be observed. Every apprentice must be paid at not less than the rate specified in the registered program for the apprentice's level of progress, expressed as a percentage of the journeymen hourly rate specified in the applicable wage determination. Apprentices shall be paid fringe benefits in accordance with the provisions of the apprenticeship program. If the apprenticeship program does not specify fringe benefits, apprentices must be paid the full amount of fringe benefits listed on the wage determination for the applicable classification. If the Administrator determines that a different practice prevails for the applicable apprentice classification, fringes shall be paid in accordance with that determination. In the event the Office of Apprenticeship Training, Employer and Labor Services, or a State Apprenticeship Agency recognized by the Office, withdraws approval of an apprenticeship program, the contractor will no longer be permitted to utilize apprentices at less than the applicable predetermined rate for the work performed until an acceptable program is approved.

(ii) **Trainees.** Except as provided in 29 CFR 5.16, trainees will not be permitted to work at less than the predetermined rate for the work performed unless they are employed pursuant to and individually registered in a program which has received prior approval, evidenced by formal certification by the U.S. Department of Labor, Employment and Training Administration. The ratio of trainees to journeymen on the job site shall not be greater than permitted under the plan approved by the Employment and Training Administration. Every trainee must be paid at not less than the rate specified in the approved program for the trainee's level of progress, expressed as a percentage of the journeyman hourly rate specified in the applicable wage determination. Trainees shall be paid fringe benefits in accordance with the provisions of the trainee program. If the trainee program does not mention fringe benefits, trainees shall be paid the full amount of fringe benefits listed on the wage determination unless the Administrator of the Wage and Hour Division determines that there is an apprenticeship program associated with the corresponding journeyman wage rate on the wage determination which provides for less than full fringe benefits for apprentices. Any employee listed on the payroll at a trainee rate who is not registered and participating in a training plan approved by

the Employment and Training Administration shall be paid not less than the applicable wage rate on the wage determination for the work actually performed. In addition, any trainee performing work on the job site in excess of the ratio permitted under the registered program shall be paid not less than the applicable wage rate on the wage determination for the work actually performed. In the event the Employment and Training Administration withdraws approval of a training program, the contractor will no longer be permitted to utilize trainees at less than the applicable predetermined rate for the work performed until an acceptable program is approved.

**(iii) Equal employment opportunity.** The utilization of apprentices, trainees and journeymen under 29 CFR Part 5 shall be in conformity with the equal employment opportunity requirements of Executive Order 11246, as amended, and 29 CFR Part 30.

**5. Compliance with Copeland Act requirements.** The contractor shall comply with the requirements of 29 CFR Part 3 which are incorporated by reference in this contract

**6. Subcontracts.** The contractor or subcontractor will insert in any subcontracts the clauses contained in subparagraphs 1 through 11 in this paragraph A and such other clauses as HUD or its designee may by appropriate instructions require, and a copy of the applicable prevailing wage decision, and also a clause requiring the subcontractors to include these clauses in any lower tier subcontracts. The prime contractor shall be responsible for the compliance by any subcontractor or lower tier subcontractor with all the contract clauses in this paragraph.

**7. Contract termination; debarment.** A breach of the contract clauses in 29 CFR 5.5 may be grounds for termination of the contract and for debarment as a contractor and a subcontractor as provided in 29 CFR 5.12.

**8. Compliance with Davis-Bacon and Related Act Requirements.** All rulings and interpretations of the Davis-Bacon and Related Acts contained in 29 CFR Parts 1, 3, and 5 are herein incorporated by reference in this contract

**9. Disputes concerning labor standards.** Disputes arising out of the labor standards provisions of this contract shall not be subject to the general disputes clause of this contract. Such disputes shall be resolved in accordance with the procedures of the Department of Labor set forth in 29 CFR Parts 5, 6, and 7. Disputes within the meaning of this clause include disputes between the contractor (or any of its subcontractors) and HUD or its designee, the U.S. Department of Labor, or the employees or their representatives.

**10. (i) Certification of Eligibility.** By entering into this contract the contractor certifies that neither it (nor he or she) nor any person or firm who has an interest in the contractor's firm is a person or firm ineligible to be awarded Government contracts by virtue of Section 3(a) of the Davis-Bacon Act or 29 CFR 5.12(a)(1) or to be

awarded HUD contracts or participate in HUD programs pursuant to 24 CFR Part 24.

**(ii)** No part of this contract shall be subcontracted to any person or firm ineligible for award of a Government contract by virtue of Section 3(a) of the Davis-Bacon Act or 29 CFR 5.12(a)(1) or to be awarded HUD contracts or participate in HUD programs pursuant to 24 CFR Part 24.

**(iii)** The penalty for making false statements is prescribed in the U.S. Criminal Code, 18 U.S.C. 1001. Additionally, U.S. Criminal Code, Section 1 01 0, Title 18, U.S.C., "Federal Housing Administration transactions", provides in part: "Whoever, for the purpose of . . . influencing in any way the action of such Administration..... makes, utters or publishes any statement knowing the same to be false..... shall be fined not more than \$5,000 or imprisoned not more than two years, or both."

**11. Complaints, Proceedings, or Testimony by Employees.** No laborer or mechanic to whom the wage, salary, or other labor standards provisions of this Contract are applicable shall be discharged or in any other manner discriminated against by the Contractor or any subcontractor because such employee has filed any complaint or instituted or caused to be instituted any proceeding or has testified or is about to testify in any proceeding under or relating to the labor standards applicable under this Contract to his employer.

**B. Contract Work Hours and Safety Standards Act.** The provisions of this paragraph B are applicable where the amount of the prime contract exceeds \$100,000. As used in this paragraph, the terms "laborers" and "mechanics" include watchmen and guards.

**(1) Overtime requirements.** No contractor or subcontractor contracting for any part of the contract work which may require or involve the employment of laborers or mechanics shall require or permit any such laborer or mechanic in any workweek in which the individual is employed on such work to work in excess of 40 hours in such workweek unless such laborer or mechanic receives compensation at a rate not less than one and one-half times the basic rate of pay for all hours worked in excess of 40 hours in such workweek.

**(2) Violation; liability for unpaid wages; liquidated damages.** In the event of any violation of the clause set forth in subparagraph (1) of this paragraph, the contractor and any subcontractor responsible therefor shall be liable for the unpaid wages. In addition, such contractor and subcontractor shall be liable to the United States (in the case of work done under contract for the District of Columbia or a territory, to such District or to such territory), for liquidated damages. Such liquidated damages shall be computed with respect to each individual laborer or mechanic, including watchmen and guards, employed in violation of the clause set forth in subparagraph (1) of this paragraph, in the sum of \$10 for each calendar day on which such individual was required or permitted to work in excess of the standard workweek of 40 hours without payment of the overtime wages required by the clause set forth in subparagraph (1) of this paragraph.

---

**(3) Withholding for unpaid wages and liquidated damages.** HUD or its designee shall upon its own action or upon written request of an authorized representative of the Department of Labor withhold or cause to be withheld, from any moneys payable on account of work performed by the contractor or subcontractor under any such contract or any other Federal contract with the same prime contract, or any other Federally-assisted contract subject to the Contract Work Hours and Safety Standards Act which is held by the same prime contractor such sums as may be determined to be necessary to satisfy any liabilities of such contractor or subcontractor for unpaid wages and liquidated damages as provided in the clause set forth in subparagraph (2) of this paragraph.

**(4) Subcontracts.** The contractor or subcontractor shall insert in any subcontracts the clauses set forth in subparagraph (1) through (4) of this paragraph and also a clause requiring the subcontractors to include these clauses in any lower tier subcontracts. The prime contractor shall be responsible for compliance by any subcontractor or lower tier subcontractor with the clauses set forth in subparagraphs (1) through (4) of this paragraph.

**C. Health and Safety.** The provisions of this paragraph C are applicable where the amount of the prime contract exceeds \$100,000.

**(1)** No laborer or mechanic shall be required to work in surroundings or under working conditions which are unsanitary, hazardous, or dangerous to his health and safety as determined under construction safety and health standards promulgated by the Secretary of Labor by regulation.

**(2)** The Contractor shall comply with all regulations issued by the Secretary of Labor pursuant to Title 29 Part 1926 and failure to comply may result in imposition of sanctions pursuant to the Contract Work Hours and Safety Standards Act, (Public Law 91-54, 83 Stat 96). 40 USC 3701 et seq.

**(3)** The contractor shall include the provisions of this paragraph in every subcontract so that such provisions will be binding on each subcontractor. The contractor shall take such action with respect to any subcontractor as the Secretary of Housing and Urban Development or the Secretary of Labor shall direct as a means of enforcing such provisions.



**Bid Information**

<b>IFB Number GHURA-11-16-2021-AMPs 1, 3 &amp; 4</b>		<b>Submit bid to:</b>  <b>GHURA</b> <b>117 Bien Venida Ave.</b> <b>Sinajana, Guam 96926</b>  Contract: Sonny Perez, 475-1404 or email <a href="mailto:sperez@ghura.org">sperez@ghura.org</a>  Andrew Manglona, 475-1315 or email <a href="mailto:amanglona@ghura.org">amanglona@ghura.org</a>
<b>Bid Opening Date:</b> Dec.16, 2021	<b>Bid Opening Time:</b> 2:00pm	
<b>Project Title:</b> Renovation of (8) Eight Public Housing Units at AMPs 1, 3 & 4		
<b>Project Description:</b> Renovation of Existing Units		
<b>Contract Completion Time:</b> See Special Conditions		
<b>Amount of Liquidated Damages:</b> \$150.00 per day		

**Bidder's Information**

<b>Name of Company</b>	<b>FEIN</b>
	<b>Bidder's Telephone Number</b>
<b>Bidder's Address</b>	<b>Bidder's Fax Number</b>
	<b>Name of Person Submitting the Bid</b>
	<b>Title of Person Submitting the Bid</b>

**Bidder's Acknowledgments**

This is to acknowledge that an authorized representative(s) of the above named company has familiarized himself/herself/themselves with the local conditions affecting the cost of the work, all instructions, General and Supplemental Conditions, Contractor's compliance and reporting requirements, the specifications, drawings, and addenda.  GHURA requires a minimum acceptance period of 60 calendar days "Acceptance period," as used in this provision, means the number of calendar days available to GHURA for awarding a contract from the date specified in this solicitation for receipt of bids. <b>GHURA reserves the option, depending on the availability of funds to award a contract to the lowest responsive bidders submitting the lowest bid on Base Bid Item No. 1 &amp; 2. A bid make be submitted for either or both bid items</b> By the submission of this bid, the bidder certifies that neither it nor any person or firm who has an interest in the bidder's firm is a person or firm ineligible to be awarded contracts by the United States Government by virtue of section 3(a) of the Davis-Bacon Act or 29 CFR 5.12(a)(1). In submitting this bid, it is understood that the right is reserved by GHURA to reject any and all bids.			
<b>Acknowledgment of Addenda</b> The bidder acknowledges the following addenda: (Failure to acknowledge may cause bid rejection.)			
<b>Addenda No.</b>	<b>Addenda Date</b>	<b>Addenda No.</b>	<b>Addenda Date</b>
	<b>Addenda Date</b>	<b>Addenda No.</b>	<b>Addenda Date</b>

**Required Submissions**

To be responsive, the bidder must submit the following documents in a sealed envelope marked on its face with the correct bidding information with his/her bid: <b>Form HUD-5369-a</b> , Representations, Certifications, and Other Statements of Bidders <b>AG form 002</b> , Disclosing ownership & Commission <b>AG form 003</b> , Affidavit re Non-Collusion <b>AG form 004</b> , Affidavit re No Gratuities or Kickbacks <b>AG form 005</b> , Affidavit re Ethical Standards <b>AG form 007</b> -Affidavit re Contingent Fees <b>Form GHURA 008c</b> , Section 3 Preference Certification completed and certified OR marked NA if the bidder is not claiming Section 3 preference.		<b>Form GHURA 09</b> , Law to be observed <b>GHURA 010</b> , Bidder's Qualifications including a Financial Statement and a certificate of authority to do business in Guam <b>Form GHURA 012</b> , Bidder's Section 3 Commitment <b>Form GHURA 014</b> , Bid Form <b>Form HUD-51000</b> , Schedule of Amounts for Contract Payments (3) original sets <b>Form GHURA 016</b> , Bid Bond and Certificates <b>Contractor's clearance from Contractor License Board</b>
GHURA shall reject a bid as non-responsive and bid that does not include	each of the above documents, fully completed and properly executed.	

**Base Bid Item No.1**

The bidder hereby proposes to furnish all labor, materials, equipment and services required to complete the design and construction contract as per the requirements of the design and specification documents for the Renovation of 2 vacant units at AMP 1 located in Asan, Sinajana and 1 vacant unit at AMP 4 located in Toto Gardens all in accordance therewith, for the sum of:

\_\_\_\_\_ DOLLARS

(\$\_\_\_\_\_)

**Base Bid Item No. 2**

The bidder hereby proposes to furnish all labor, materials, equipment and services required to complete the design and construction contract as per the requirements of the design and specification documents for the Renovation of 5 vacant units at AMP 3 located in Agat, Umatac and Merizo all in accordance therewith, for the sum of:

\_\_\_\_\_ DOLLARS

(\$\_\_\_\_\_)

**A Unit breakdown is required for each unit as noted below**

Item #	Item Description	Estimated Quantity	Unit		Unit Bid Price
			Measure	Price	
<b>Base Bid No 1</b>					
1	1A Atis Court, AMP 1, Sinajana				\$
2	19 MJLG AMP 1, Asan				\$
3	9A Calle Damian, AMP 4, Toto Gardens				\$
					\$
					\$
					\$
<b>Base Bid No. 2</b>					
1	41 Mao, AMP 3, Agat				\$
2	84 Mao, AMP 3, Agat				\$
3	A20 (upper GHURA-82), Agat				\$
4	184 JQQ, Umatac				\$
5	134 SD, Merizo				\$

The bidder may continue by copying and attaching this section to the Bid Form.

<b>Sum of all cost extensions are included in the base bid</b>	<b>\$</b>
--	-----------

**Additive Bid Items**

**GHURA does not require** an additive bid for this proposal. To offer a bid the bidder is requested to breakout the following items from the base bid. Each item shall include all labor, materials, equipment and services required to complete

Item #	Item Description	Item Bid

**Individual Bidder**

<p><b>Trading and doing business as</b></p> <p>If fictitious trade name is employed in the conduct of business, insert such name and complete, as appropriate. This foregoing fictitious or trade name <input type="checkbox"/> is <input type="checkbox"/> is not a been registered under Guam Law.</p>	<p><b>Bidder's Signature</b> _____</p> <p><b>Date</b> _____</p>
<p><b>Name of person submitting the bid</b></p>	<p><b>Witness</b></p> <p>Witness Name _____</p> <p>Witness Signature _____</p> <p>Date _____</p>
<p><b>Business address</b></p>	

**Partnership Bidder**

<p><b>Name of Partnership</b></p> <p>If fictitious trade name is employed in the conduct of business, insert such name and complete, as appropriate. This foregoing fictitious or trade name <input type="checkbox"/> is <input type="checkbox"/> is not a been registered under Guam Law.</p>	<p><b>Bidder's Signature</b> _____</p> <p><b>Date</b> _____</p>
<p><b>Name of person submitting the bid</b></p>	<p><b>Witness</b></p> <p>Witness Name _____</p> <p>Witness Signature _____</p> <p><b>Date</b> _____</p>
<p><b>Business address</b></p>	

**Corporate Bidder**

<b>Name of Corporation</b>	<b>Corporate's Signature</b> _____ <b>Title</b> _____ <b>Date</b> _____
<b>Name of person submitting the bid</b>	<b>Certificate as to Corporate Principle</b> I, _____, certify that I am the Secretary of the corporation named as Principal in the within bond: That _____ _____ , who signed the bond on behalf of the Principal, was then of said corporation; that I know his signature, and his signature thereto is genuine; and that said bond was duly signed, sealed, and attested to for and I behalf of said corporation by authority of its governing body.  _____ (Corporate Seal)
<b>Business address</b>	

# Schedule of Amounts for Contract Payments

U.S. Department of Housing and Urban Development  
Office of Public and Indian Housing

OMB Approval No. 2577-0157  
(Exp. 11/30/2023)

No progress payments shall be made to the contractor unless a schedule of amounts for contract payments in accordance with the construction contract is received.

Public reporting burden for this collection of information is estimated to average 1 hour per response, including the time for reviewing instructions, searching existing data sources, gathering and maintaining the data needed, and completing and reviewing the collection of information. HUD may not conduct or sponsor, and an applicant is not required to respond to a collection of information unless it displays a currently valid OMB control number. Construction practices and HUD administrative requirements establish the need that HAs maintain certain records or submit certain documents in conjunction with the oversight of the award of construction contracts for the construction of new low-income housing developments or modernization of existing developments. These forms are used by HAs to provide information on the construction progress schedule and schedule of amounts for contract payments. Responses to the collection of information are required to obtain a benefit or to retain a benefit. The information requested does not lend itself to confidentiality.

Project Name and Location	Project Number
---------------------------	----------------

Name, Address, and Zip Code of Contractor
---

Nature of Contract	Contract Number
--------------------	-----------------

Approved for Contractor by	Title	Date (mm/dd/yyyy)
----------------------------	-------	-------------------

Approved for Architect by	Title	Date (mm/dd/yyyy)
---------------------------	-------	-------------------

Approved for Owner by	Title	Date (mm/dd/yyyy)
-----------------------	-------	-------------------

Item No. (1)	Description of Item (2)	Quantity (3)	Unit of Measure (4)	Unit Price in Place (5)	Amount of Sub-Item (6)	Amount of Principal Item (7)

<b>Total Amount of Contract or Carried Forward</b>	\$
--	----

To the best of my knowledge, all the information stated herein, as well as any information provided in the accompaniment herewith, is true and accurate. **Warning:** HUD will prosecute false claims and statements. Conviction may result in criminal and/or civil penalties. (18 U.S.C. 1001, 1010, 1012; 31 U.S.C. 3729, 3802)

Signature of authorized representative	Date signed (mm/dd/yyyy)
--	--------------------------

## Instructions for Preparation of form HUD-51000

1. A separate breakdown is required for each project and prime contract instructions for preparation are given below.
  - a. **Heading.** Enter all identifying information required for both forms.
  - b. **Columns 1 and 2.** In column 1, enter the item numbers starting with No. 1, and in column 2 enter each principal division of work incorporated in the contract work.
    - (1) **Master List.** The Master list contains the basic items into which any construction contract may be subdivided for the purpose of preparing the Construction Progress Schedule and the Periodical Estimates for Partial Payments. Only those items shall be selected which apply to the particular contract. To ensure uniformity, no change shall be made in the item numbers. Generally, about 25 to 40 major items appear in a contract.
    - (2) **Items Subdivided.** In the Contractor's breakdown, against which all periodical estimates will be checked prior to payment, each major item must be subdivided into sub-items pertinent to the project involved and in agreement with the Contractor's intended basis for requesting monthly payments.
  - c. **Column 3.** Enter the total quantity for each sub-item of each principal division of work listed in the breakdown.
  - d. **Column 4.** Enter the appropriate unit of measure for each sub-item of work opposite the quantities described in column 3, such as "sq. ft.," "cu. yd.," "tons," "lb.," "lumber per M/BM," "brickwork per M," etc., applicable to the particular sub-item. Items shown on "lump sum" or equivalent basis will be paid for only on completion of the whole item and not on a percentage of completion basis.
  - e. **Column 5.** Enter the unit price, in place, of each sub-item of work.
  - f. **Column 6.** Enter the amount of each sub-item obtained by multiplying the quantities in column 3 by the corresponding unit prices in column 5.
  - g. **Column 7.** Enter the amount of principal item only, obtained by adding the amounts of all sub-items of each principal division of work listed in column 6. Continue with the breakdown on form HUD-51000.
  - h. The "Schedule of Amounts for Contract Payments" shall be signed and dated in the space provided at the bottom of each sheet of the form by the individual who prepared the breakdown for the Contractor.
2. The minimum number of copies required for each submission for approval is an original and two copies. When approved, one fully approved copy will be returned to the Contractor.

### Master List of Items

Item No.	Division of Work	Item No.	Division of Work	Item No.	Division of Work
1	Bond	20	Rough Carpentry		
2	General Conditions	21	Metal Bucks	44	<b>Site Improvements</b> Retaining Walls
3	Demolition & Clearing	22	Caulking	45	Storm Sewers
	<b>Structures</b>	23	Weatherstripping	46	Sanitary Sewers
4	General Excavation	24	Lath & Plastering-Drywall	47	Water Distribution System
5	Footing Excavation	25	Stucco	48	Gas Distribution System
6	Backfill	26	Finish Carpentry	49	Electrical Distribution System
7	Foundation Piles & Caissons	27	Finish Hardware	50	Street & Yard Lighting
8	Concrete Foundations	28	Glass & Glazing	51	Fire & Police Alarm System
9	Concrete Superstructures	29	Metal Doors	52	Fire Protection System
10	Reinforcing Steel	30	Metal Base & Trim	53	Street Work
11	Waterproofing & Dampproofing	31	Toilet Partitions	54	Yard Work
12	Spandrel Waterproofing	32	Floors	55	(Other)
13	Structural Steel	33	Painting & Decorating	56	(Other)
14	Masonry	34	Screens		
15	Stonework	35	Plumbing		<b>Equipment</b>
16	Miscellaneous & Ornamental Metal	36	Heating	57	Shades & Drapery Rods
17	Metal Windows	37	Ventilating System	58	Ranges
18	Roofing	38	Electrical	59	Refrigerators
19	Sheet Metal	39	Elevators	60	Kitchen Cabinets & Work Tables
		40	Elevator Enclosures—Metal	61	Laundry Equipment
		41	Incinerators—Masonry & Parts	62	(Other)
		42	(Other)		
		43	(Other)	63	<b>Punch List</b> <sup>1</sup> / <sub>2</sub>
				64	Lawns & Planting

1 General Conditions should be 3% to 5% of contract amount.

2 Punch List should be approximately 1/2 of 1% or \$30 per dwelling unit, whichever is greater.

**BID BOND**

KNOW ALL MEN BY THESE PRESENTS, that we the undersigned \_\_\_\_\_

\_\_\_\_\_  
(Name of Principal)

as PRINCIPAL, and

\_\_\_\_\_  
SURETY

are held and firmly bound unto Guam Housing and Urban Renewal Authority, hereinafter called "GHURA", in the penal sum of \_\_\_\_\_

\_\_\_\_\_  
Dollars, ( \_\_\_\_\_ ), lawful money of the United States, for the payment of which sum will and truly be made, we bind ourselves, our heirs, executors, administrators and successors, jointly and severally, firmly by these presents.

THE CONDITION OF THIS OBLIGATION IS SUCH, that whereas, the Principal has submitted the accompanying bid, dated the \_\_\_\_\_, 20\_\_\_\_, for the \_\_\_\_\_

NOW THEREFORE, if the principal shall not withdraw said bond within the period specified therein after the opening of the same, or, if no period be specified, within sixty (60) days after the said opening, and shall within ten (10) days after the prescribed forms are presented to him for signature, enter into a written contract with Guam Housing and Urban Renewal Authority in accordance with the bid as accepted, and give bond with good and sufficient surety or sureties, as may be required, for the faithful performance and proper fulfillment of such contract; or in the event of the withdrawal of said bid within the period specified, or time specified, if the principal shall pay Guam Housing and Urban Renewal Authority, the difference between the amount specified in said bid and the amount for which Guam Housing and Urban Renewal Authority may procure the required work or supplies, or both, if the latter amount be in excess of the former, then the above obligation shall be void and of no effect, otherwise to remain in full force and virtue.

IN WITNESS WHEREOF, the above bounden parties have executed this instrument under their several seals this \_\_\_\_\_ day of \_\_\_\_\_ 20\_\_\_\_, the name and corporate seal of each corporate party being hereto affixed and these presents duly signed by its undersigned representatives, pursuant to authority of its governing body.

ATTEST:

Sole Proprietorship

---

---

\_\_\_\_\_  
(Individual Principal Signature)

\_\_\_\_\_  
(Business Address)

\_\_\_\_\_  
(Name of Individual Principal Above)

(Seal)

---

ATTESTED:

Corporation

---

---

\_\_\_\_\_  
(Corporate Principal Signature)

\_\_\_\_\_  
(Business Address)

\_\_\_\_\_  
(Name of Corporate Principal Above)

\_\_\_\_\_  
(Title)

Affix Corporate Seal



ATTEST:

Surety Company

---

---

\_\_\_\_\_  
(Corporate Surety Signature)

\_\_\_\_\_  
Corporate Surety Signature)

\_\_\_\_\_  
(Business Address)

\_\_\_\_\_  
Name of Corporate Surety)

\_\_\_\_\_  
(Title)

Affix Corporate Seal

\_\_\_\_\_  
(Power of Attorney for person signing for Surety Company must be attached to the Bond)

### CERTIFICATE AS TO CORPORATE PRINCIPAL

I, \_\_\_\_\_, certify that I am the \_\_\_\_\_

Secretary of the Corporation names as Principal in the within the bond; that  
\_\_\_\_\_ " who signed the said bond on behalf of the

Principal was then \_\_\_\_\_ of said corporation; that I know his

signature, and his signature thereto is genuine; and that said bond was duly signed,

sealed, and attested to, for and *in* behalf of said corporation by authority of its governing

body.

\_\_\_\_\_  
(Corporate Seal)

THIS AGREEMENT MADE THIS \_\_\_\_ day of \_\_\_\_\_ in the year \_\_\_\_ by and between \_\_\_\_\_, A Corporation, Partnership or Sole Proprietorship existing under the laws of the State of \_\_\_\_\_ Guam hereinafter called the "Contractor," and the Guam Housing and Urban Renewal Authority, herein called the "GHURA."

WITNESSETH, that the Contractor and GHURA for the consideration stated herein, mutually agree as follows:

ARTICLE I

Statement of Work. The Contractor shall furnish all labor, material, equipment, and services and perform and complete all work required for the construction of Project No. GHURA-11-16-2021-AMPs 1, 3 & 4, in strict accordance with "Specifications" for the ,which includes all items listed in the Tale of Contents and Addenda thereto, Numbered and the drawings referred to herein, all as prepared by Architect, which said Specifications, Addenda and Drawings are incorporated herein by reference and made a part hereof.

ARTICLE II

Contract Price. GHURA shall pay the Contractor for the performance of the Contract, in current funds, subject to additions and deductions as provided in the specifications for completed work meeting the requirements of the Contract Documents, the sum of (\$ \_\_\_\_\_)

ARTICLE III

Contractor agrees that time is of the essence in the completion of the work in the time required by this contract and hereby waives any notice of putting in default for failure to complete on time.

ARTICLE IV

Contract Documents. The contract shall consist of the following component parts:

- (a) This Instrument
- (b) General Conditions
- (c) Special/supplemental Conditions
- (d) Technical Specifications
- (e) Drawings
- (f) IFB # GHURA-11-16-2021-AMPs 1, 3 & 4
- (g) Forms
- (h) Proposal
- (l) Schedule of Amounts for Contract Payments (3) original sets
- (j) Addendum

This instrument, together with the other documents enumerated in this ARTICLE IV, which said other documents are as fully a part of the Contract as if hereto attached or herein repeated, form the Contract. In the event that any provision of any other component part of this Contract conflicts with any provision of any other component part, the provision of the component part first enumerated in the ARTICLE IV shall govern, except as otherwise specially stated. The various provisions in Addenda shall be construed in the order of the preference of the component part of the Contract which each modifies.

IN WITNESS WHEREOF, the parties hereto have caused this Instrument to be executed in \_\_\_\_\_ three (3) original counterparts as of the day and year first above written

Name: \_\_\_\_\_

Executed by: **Ray S. Topasna**  
Executive Director for the Guam Housing Urban  
Renewal Authority

Signature: \_\_\_\_\_

Signature: \_\_\_\_\_

Title: \_\_\_\_\_

Date: \_\_\_\_\_

Company Name: \_\_\_\_\_

Date: \_\_\_\_\_

**Contractor's Certification**

I, \_\_\_\_\_, certify that I am the \_\_\_\_\_  
\_\_\_\_\_, of the Corporation named as Contractor herein,  
(Title)  
and that \_\_\_\_\_, who signed the Contract on behalf of the Contractor, was  
(Name of Signatory)  
then the \_\_\_\_\_ of said Corporation; that said  
Contract was duly signed for and in behalf of said Corporation by authority of its governing body,  
and is within the scope of its corporate powers.

(Corporate Seal) \_\_\_\_\_  
Signature of person affixing the Corporate Seal

Funds Certified By: \_\_\_\_\_  
Controller

Date: \_\_\_\_\_

Grant No.	Project Number	Amount	

## SPECIAL CONDITIONS

- I. PROJECT SITE and DESCRIPTION: The project consisted of four (2) Basic Bids, see attached scope of work for locations.
  - **Basic Bid 1** consisted of three (3) units and are located in Amp1, Asan, Sinajana & . and AMP4 Toto
  - **Basic Bid 2** consisted of five (5) units and is all located in Amp4, Agat, Umatac & Merizo.
  
- II. TIME OF COMPLETION: The work shall commence at the time stipulated in the Notice to Proceed and shall be fully completed within the time frame of:  
**Basic Bid 1; 90 consecutive calendar days.**  
**Basic Bid 2; 120 consecutive calendar days.**
  
- III. LIQUIDATED DAMAGES: In case of failure on part of the Contractor to complete the work within the time fixed in the Contract, or within any time extensions given thereof, the Contractor and his sureties shall be liable for and shall pay the Housing Authority the sum of **\$150.00** liquidated damages per unit, per calendar days of delay until the work is completed or accepted.
  
- IV. SCOPE OF WORK:  
OBJECTIVE – It is the intent of Guam Housing and Urban Renewal Authority to modernize units as per scope of work (see attached Scope of work and drawings for locations).

Notes:

1. Prior to start of construction the contractor shall field verify actual dimensions, conditions and locations and shall immediately notify GHURA of any discrepancies between the plans for this project and actual field conditions which may interfere with this project.
  2. The contractor shall coordinate and obtain all necessary clearance from all Government agencies prior to any work activity within government utility side. Damaged done by the contractor to any existing GOVGUAM utility lines shall be repaired by the contractor at no cost to the Government. Repair work shall be per GOVGUAM standards and approval.
  3. The contractor shall be responsible for discussing the consumption of utilities with each tenant, and decide on an agreed amount for reimbursement of utility usage. The contractor shall have this agreement documented in writing. The contractor will be held responsible for reimbursing tenants upon completion of their unit.
  4. All notices, demands, requests, instructions, approvals, proposals and claims must be in writing.
- 
1. BUILDING INTERIOR CLEANING TO COMMON AREAS:
    - a. General Requirements: All construction debris accumulated during construction to be removed and disposed from the project site; do not allow accumulations. Store materials that cannot be removed daily in areas specified by the Contracting Officer.

- b. Debris and Rubbish: Remove and transport debris and rubbish in a manner that will prevent spillage on pavements, streets or adjacent areas. Clean up spillage from pavements, streets and adjacent areas.
- c. Dust and Debris Control: Prevent the spread of dust and debris and avoid the creation of a nuisance or hazard in the surrounding area.

2. EXTERIOR DOORS:

- a. Existing Exterior Doors: Entry/Exit to be removed and replace with new aluminum door and frame (size match existing wall opening) with screen door. Provide new lever type lockset and accessories (hinges, doorstopper and threshold) Lockset shall be UNIVERSAL type (1 key to open Entry, Exit and Storage doors). Upon unit's turn over to GHURA, contractor to submit 4-sets of keys. All existing screen doors to be salvaged and turn-in to Ghura Site base AMP office.

3. INTERIOR DOORS (change out as noted in the detail scope of work):

- a. Existing Interior Doors: Doors (see scope of work) to be removed and replace with new Solid Core (SCD) door and frame (size match existing wall opening). Provide new lever type lockset and accessories (hinges, doorstopper and threshold). Lockset shall be PRIVACY BED/BATH LEVER type.

4. CARPENTRY:

ADJUSTMENT, CLEANING, FINISHING AND PROTECTION

- a. Existing wood works (doors, kitchen cabinets, closets and wood stairs) repair damaged and defective finish carpentry work wherever possible to eliminate defects functionally and visually. Adjust joinery for uniform appearance.
- b. All termite infested wood to be removed and replace with new wood to match existing in kind, unless otherwise noted.

5. PAINTING (as noted in the detail scope of work):

- a. Interior wall (see on scope of work) painting shall be acrylic gloss paint, ceiling shall be acrylic semi-gloss and all wood work shall be enamel type paint.
- b. Paint color codes= Ceiling- SW1004; Walls- SW 1095; Woodwork and trim – SW6069. Exterior paint code = CW031W Coconut Spirit
- c. Wall base paint 4" high paint trims continuous at bottom of wall. Wall/floor corner to provide continuous caulking.
- d. Repair all uneven surface (concrete/wood) and remove all unnecessary hardware from ceiling and walls prior to painting.
- e. For all new painting works and touch up paint shall be approved use two coats of Sherwin Williams Paint or approved equal. Contractor to coordinate with Site Base AMP management for color/type of paint.

6. PLUMBING:

- a. Provide new Water shut-off (ball valve) 10'ft after main water meter valve with cover assembly & reinforced concrete collar.

SEWER REPLACEMENT:

- b. Existing waste (see scope of work) lines interior and exterior to be completely removed and replaced w/ new ABS waste line, pipe size see attached drawings, contractor to submit shop drawings for review and approval. Work to include

sawcut of existing slab on grade, portion of slab & ceramic tiles to be demolished, disposed and restored to original condition (new work to match existing in-kind).

- c. All new waste line placement and connection shall be inspected by Ghura prior to burial , ground clean-out shall be reinforced with #3 all around and 4inches thick concrete collar 18inches diameter minimum

7. ELECTRICAL PANEL BOARD REPLACEMENT (*see scope of work*):

- a. All new work shall be under direct supervision of Master Electrician. The Contractor shall hire Registered Electrical engineer to design, prepare and certify the construction drawings to be used on site. The contractor shall provide GHURA certification from the Master Electrician stating all new work was under his/her direct supervision. The Contractor shall energize the new electrical panel board and verify all electrical system are in good working condition.

8. OTHERS:

- a. Existing clothes line: Provide new stainless-steel wire #9-gage 20LFx4.
- b. Provide new kitchen base counter (see scope of work if required): Existing Kitchen base counter(s) to be demolished and disposed. New base counter layout and dimensions to match existing in-kind. Provide new 2x2 steel frame tubes (all stl. Frame connection shall be fully welded), 3-layers of 1/2in thick cement board (provide tin set mortar adhesive between cement board) and fasten to steel frame, 24inches square ceramic tiles with bull nose at all edges, wall ceramic tiles above counter, cement board at counter side walls and shelve shall be one or two (two CB to avoid sagging), all drawers shall be 3/4<sup>in</sup>. thick plywood with roller guide and handle. All cabinet doors shall include two hinges per door and handle. Contractor to submit shop drawings for review & approval prior to start of work.

GENERAL NOTES:

1. FIELD VERIFICATION; Contractor shall field verify existing conditions, pipe inverts, dimensions prior to bidding. Contractor to notify GHURA contracting officer of any discrepancies between scope of work, actual field conditions and project intent which may interfere with this project.
2. PROTECTION: Provide temporary fences, barricades, coverings, or other protection to preserve existing items indicated to remain and to prevent injury or damage to persons or property. Provide protection for adjacent properties; restore damaged work to condition existing prior to start of work.
3. MISCELLANEOUS ITEMS of WORK not indicated but which are necessary to implement the project intent of which are customarily performed shall be provided by the Contract Bidder as if fully and correctly described in the scope of work and/or drawings. Contractor to notify GHURA official prior to commencement of work.
4. PERMITS & CLEARANCES: The contractor shall obtain building permit, coordinate and obtain Registered Licensed Engineer for preparation of Construction drawings and all necessary clearance from all Government agencies

prior to any work activity within government utility side. Damaged done by the contractor to any existing GOVGUAM utility lines shall be repaired by the contractor at no cost to the Government. Repair work shall be per the Government of Guam standards and approval.

5. SHOP DRAWINGS: Prior to commencement of work, contractor to provide shop drawings for review and approval; contractor shall also provide an electronic copy.

V. See attached Detail layouts and site plan

VI. SITE: The site is described on the site location plan. Bidders shall verify existing structure, site conditions and all pertinent information needed for the satisfactory performance of the scope of work prior to submitting the bid.

#### VII.COMMUNICATIONS

- A. All notices, demands, requests, instructions, approvals, proposals, and claims must be in writing.
- B. Any notice to or demand upon the Contractor shall be sufficiently given if delivered at the office of the Contractor stated on the signature page of the Contract (or at such office as he may from time to time designate in writing to GHURA ), or deposited in the United States mail in sealed, postage-prepaid envelope, or if delivered with charges prepaid to any telegraph company for transmission, in each case addressed to such office.
- C. All papers required to be delivered to GHURA shall, unless otherwise specified in writing to the Contract, be delivered to the Guam Housing and Urban Renewal Authority at 117 Bien Venida Avenue, Sinajana, Guam, 96926, and any notice to or demand upon GHURA shall sufficiently given if so delivered, or deposited in the United States mail in sealed, postage-prepaid envelope, or delivered with charges prepaid to any telegraph company for transmission to said Guam Housing and Urban Renewal Authority at such address as GHURA may subsequently specify in writing to the Contractor for such purposes.
- D. Any such notice shall be deemed to have been given as of the time of actual delivery or (in the case of mailing) when the same should have been received in due course of post, or in the case of telegrams, at the time of actual receipt, as the case may be.
- E. Signs- N/A  
The Contractor shall erect a sign at the project site at his own expense. The location of the sign shall be as directed by the Contracting Officer. Lettering of sign, and other pertinent data that should appear on the sign will be furnished by the Contracting Officer to the Contractor.

VIII. Any damages to existing conditions shall be repaired in good condition with finish to match existing.

- IX. MINIMUM RATES OF PAY AND WAGE RATES- See attach General Decision
- X. UTILITIES CONSUMPTION- N/A  
The contractor shall be responsible for providing utilities required in the performance of this contract.
- XI. DOCUMENTS REQUIRED PRIOR TO FINAL PAYMENT  
Prior to final payment, and before the issuance of final certificate for payment in accordance with the provisions of the General Conditions, file the following papers with the GHURA.
- Project Record Documents
- XII. CLEAN UP

The Contractor shall, at all times, keep the premises free from accumulations waste materials or rubbish caused by his operations. At the completion of the work, he shall remove all his waste materials and rubbish from and about the sites as well as all his tools, construction equipment, machinery and surplus materials and shall clean all glass surfaces and leave the work "broom clean" or its equivalent, except as otherwise specified. If the Contractor fails to clean up, GHURA may do so and cost thereof shall be charged to the Contractor as provided in Paragraph 31 of the General Conditions. If a dispute arises between the separate contractors as to their responsibility for cleaning up, GHURA shall clean up and charge the cost thereof to the several contractors as GHURA shall determine to be just.

NOTE: "The use of Lead-based both in Paint or Solder is prohibited."  
\*\*\*End of Special Conditions\*\*



# BASIC BID 1

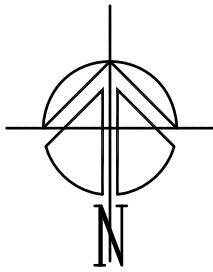

PHILIPPINE  
SEA

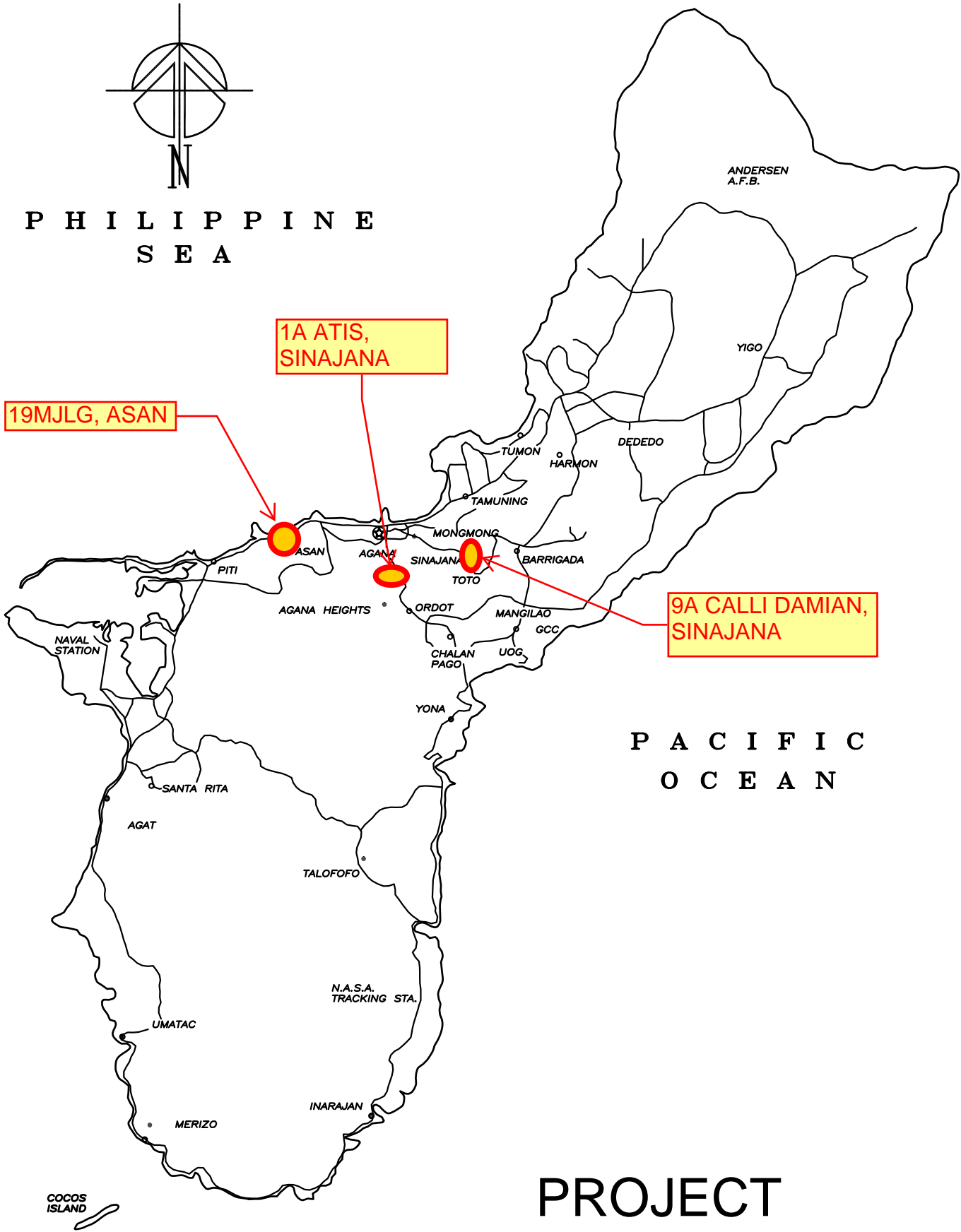

PACIFIC  
OCEAN

# PROJECT LOCATION MAP

**1A ATIS CT., GHURA-250, SINAJANA (3 bedroom)**

## GENERAL NOTES:

- See SPECIAL CONDITIONS for front and rear EXTERIOR door replacement. Replace exterior storage closet doors to single 36" centered aluminum door and jamb with ½" cement board on metal frame (or CMU) in-fill on sides. Locksets are to be universally keyed (one key fits all)
- Remove floor tiles throughout unit and replace w/ similar tiles. Submit sample for approval. Level floor where necessary and ensure new tiles are entirely clean (free of dust, dirt, grease) and apply 2 coats minimum of wax. Caulk tile edging at walls.
- Remove cove base where existing and provide 4" continuous paint trimming at bottom of walls (Paint code: SW6069).
- Perform termite treatment on unit per manufacturer's specifications. Warranty to be minimum 5 years.
- Keyed locksets and deadbolts in good condition to be given (w/ keys) to AMP management for re-use.
- The Contractor is required to submit shop drawings and material submittals for review and approval prior to start of work.

## 1. KITCHEN

Existing Sink base cabinets to be demolished and disposed. Provide new base cabinets; base cabinet's lay-out shall match existing in-kind. **Submit drawings for approval.**

New Base Cabinet shall consist with:

- Concrete floor base 3" thick reinforced (#3@8"O.C. each way centered)
- Cabinet frames (vertical & horizontal) shall be 2"x2"x 11ga (.120") Steel Square tube, all joints shall be full weld primer painted (gray color).
- Counter tops shall be 3 layers of ½" thick cement board with Thin-set mortar bonding (or Equivalent) between each board, ¼" stainless steel countersunk screw fastened at 12" maximum on center. Ceramic tile 12" min. and bull-nose at all edges. Submit sample for approval.
- Cabinet side end walls shall be 2 layers of ½" thick cement board with Thin-set mortar between layers and ¼" stainless steel countersunk screw fastened at 12" maximum on center.
- Shelves, cabinet drawers and doors shall be ¾" thick termite treated wood.
- Replace Kitchen sink with all new accessories to include lever-type faucet (non-corrodible metal), sink drain, ½" x ½" angle valves. Replace wall nipple.

## 2. EXTERIOR

- Demolish and Remove exterior sink and concrete shelf. Install free-standing fiberglass sink. Sink to be secured to floor and wall.
- Provide new stainless steel wire #9 gauge 25LFx4 for clotheslines
- Provide new water shut-off (ball valve) 6" after main water meter box with appropriate encasement.

**3. Electrical work removal and modification**

- A. Electrical system to be up-graded based on most current international Electrical Code.
- B. Existing Electrical system up-grade shall consist of new light fixtures, outlets and switches throughout unit. Outlet and switch covers to be flexible vinyl composition. Light fixtures to have clear/opaque diffusers that can be removed without the use of a tool and be installed with energy star rated bulbs.
- C. Existing wiring to be used where feasible. Surface mounted rigid conduit with new wiring to be used where necessary.
- D. Existing electrical system panel box to be remove completely and replace with new recessed Panel box.
- E. See attached work scope for further details

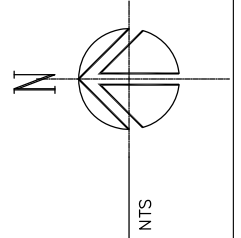
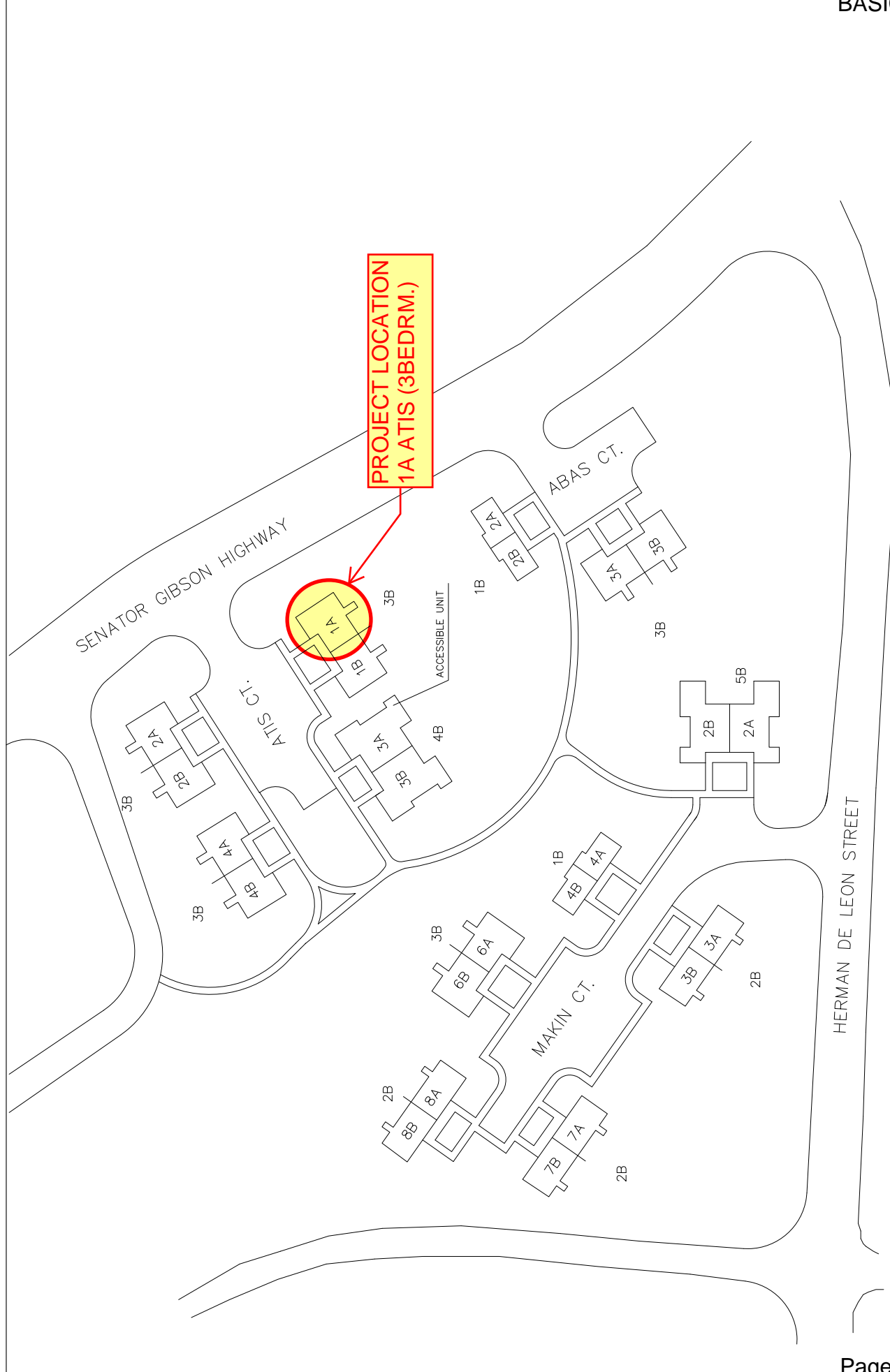

**SITE PLAN**  
**SINAJANA**

## ELECTRICAL UP-GRADE SCOPE OF WORK

### 1. ELECTRICAL WORK REMOVAL and MODIFICATION

- a. Change-out existing electrical 100-amp panel box to new **125-amp** Electrical panel with new circuit breakers, contractor to field verify existing condition prior to panel removal. Contractor to comply with latest International Electrical Code. New electrical panel box shall be “recess mounted”, ensure ground wire are properly connected to new panel box, provide new directory listing of circuits.
- b. Existing Electrical system upgrade shall consist New light fixtures, outlets and switches shall be replace with new (match in-kind). Replaced all outlet and switch covers to be flexible vinyl composition. New Light fixtures to have clear diffusers and be provided with energy star rated bulbs.
- c. Verify existing wiring system for voltage continuity; damaged wires shall be replaced with new wires (match wire size in-kind). Surface mounted rigid conduit with new wiring to be used where necessary.
- d. Additional circuit breakers shall be arranged equally across phase to prevent overloading any phase in the panel board. Provide new typewritten directory indicating revised equipment controlled by each circuit breaker. Touch-up repair and paint required at effected areas damaged where new work is required.

#### Note:

Existing Electrical Panel change out work shall be replaced with new **125-amp**, consisted of approved design drawings to accommodate construction activities associated to remove and replacement of existing electrical panel board. New panel board to accommodate existing and additional loads required. Registered Electrical Engineer shall approve design drawings. Prior to start of work the Contractor and/or Registered Electrical Engineer shall field verify and determine actual loads and field condition.

- a. IDENTIFICATION and ANALYSIS of UNCERTAINTIES; an assumption has been made that the existing electrical wires are suitable for reuse after modification/installation of new panel board. If one or more wires cannot be used as is after modification, then replacement is required. Sufficient contingency to accommodate/modification replacement shall be allocated in the contractors bid cost.
- b. Coordinate item No. 3 and 4 below for additional circuits.
- c. Contractor shall coordinate and obtained approval with Department of Public Works and Guam Power Authority necessary clearance to achieve competition under this activity.

- d. Contractor to install new grounding rod 8ft. long, ensure proper bonding to new electrical panel, connection and continuity to all outlets & light fixtures. Ensure impedance to ground is less than 25 ohms per specified in NEC 250.56.
  - e. Contractor shall obtain certified Master Electrician to verify work compliance, document, record and trace all circuits, raceways connection to all outlets, light fixtures and circuits and submit to Ghura for “AS-BUILT” record.
2. Test all electrical system to ensure all components are operational.
  3. Provide one (1) new outlet provision for Air Condition 12,000 BTU (window type) at bedrooms adjacent to existing window. New Air Condition shall consisted with separate circuit breakers 1-30amp/110-volts, #12AWS. See attached floor plan for location of new outlets.
  4. Provide one (1) new outlet provision for Air Condition 24,000BTU (window type) at Living Room with circuit breaker 1-30amp/220-volts. See attached floor plan for location of new outlet. Wires shall be #10AWS

General Notes:

1. FIELD VERIFICATION; Contractor shall field verify existing conditions, pipe inverts, dimensions prior to bidding. Contractor to notify GHURA contracting officer of any discrepancies between scope of work, actual field conditions and project intent which may interfere with this project.
2. PROTECTION: Provide temporary fences, barricades, coverings, or other protection to preserve existing items indicated to remain and to prevent injury or damage to persons or property. Provide protection for adjacent properties; restore damaged work to condition existing prior to start of work.
3. MISCELLANEOUS ITEMS of WORK not indicated but which are necessary to implement the project intent of which are customarily performed shall be provided by the Contract Bidder as if fully and correctly described in the scope of work and/or drawings. Contractor to notify GHURA official prior to commencement of work.
4. PERMITS & CLEARANCES: The contractor shall obtain building permit, coordinate and obtain Registered Licensed Engineer for preparation of Construction drawings and all necessary clearance from all Government agencies prior to any work activity within government utility side. Damaged done by the contractor to any existing GOVGUAM utility lines shall be repaired by the contractor at no cost

to the Government. Repair work shall be per the Government of Guam standards and approval.

5. ELECTRICAL WORK: All work shall under supervision of Master Electrician.
6. SHOP DRAWINGS: Prior to commencement of work, contractor to provide shop drawings for review and approval; contractor shall also provide an electronic copy.

NOTE: "The use of Lead-based both in Paint or Solder is prohibited."  
\*\*\*End of Special Conditions\*\*



note:  
See attached existing (3bedrm.)  
electrical panel board detail &  
location and Scope of work

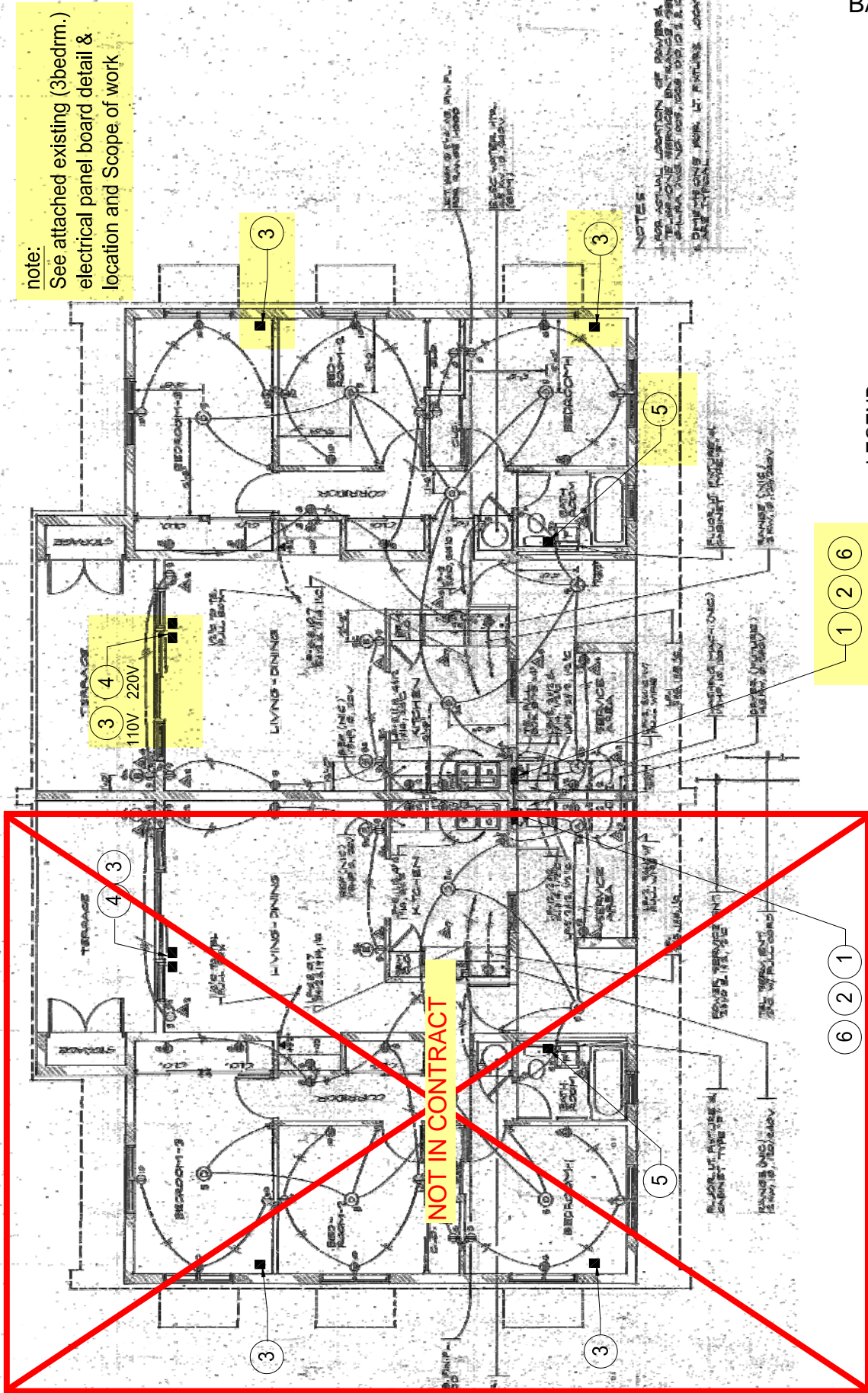

NOT IN CONTRACT

1 2 6

6 2 1

LEGEND:

3 BEDROOM ELECTRICAL FLOOR PLAN  
(AS-BUILT)

1 - SCOPE OF WORK DESIGNATION NUMBER

EXISTING ELECTRICAL PANEL - 3 BEDROOM (AS-BUILT)

PANEL "LP" (LOAD SCHEDULE)		12 AWG 201/240V		FLUSH MOUNTED	
LOCATION	VA LOAD	NEC OUTLET	NEC BRK	NEC BRK	LOCATION
(RANGE)	2000	1	#6 50A	2	(DRYER), HALLWAY
(ELEC. WATER HTR.)	2250	1	#10 30A	4	S P A C E
SERV AREA, KITCHEN	720	8	#12 20A	6	BEDROOM 1, 2, 3
BEDROOM 1, 2, 3, BATH	1500	4		8	CL, LIVING, DINING
KITCHEN	1480	1		10	BEDROOM 1, 2, 3
TERR, LIVING, DINING	1500	1		12	KITCHEN, SERV AREA
KITCHEN					
MAIN'S 7P 100AF 100AT CB					
TOTAL VA 16,700 VA					
TOTAL DBS 16,410 VA					
TOTAL CONNECTED LOAD 3,110 VA					
TOTAL DEMAND LOAD 2,190 VA					

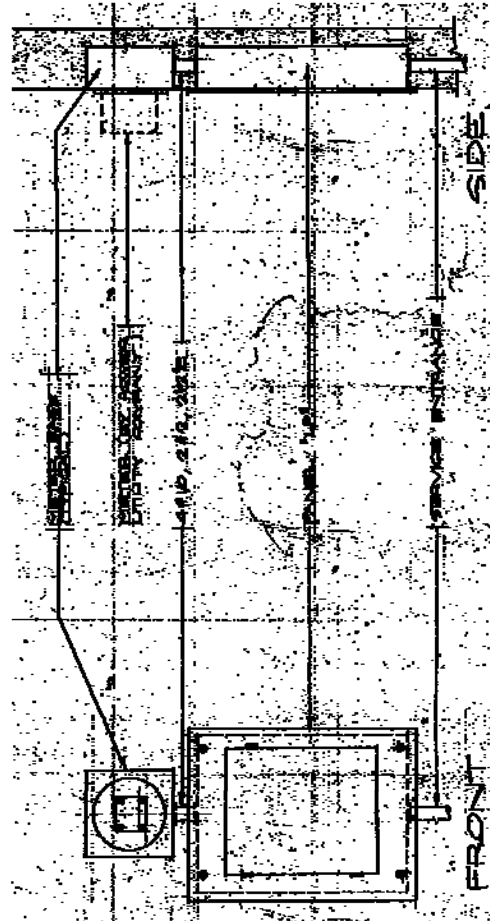

EXISTING ELECTRICAL PANEL DETAIL (AS-BUILT)

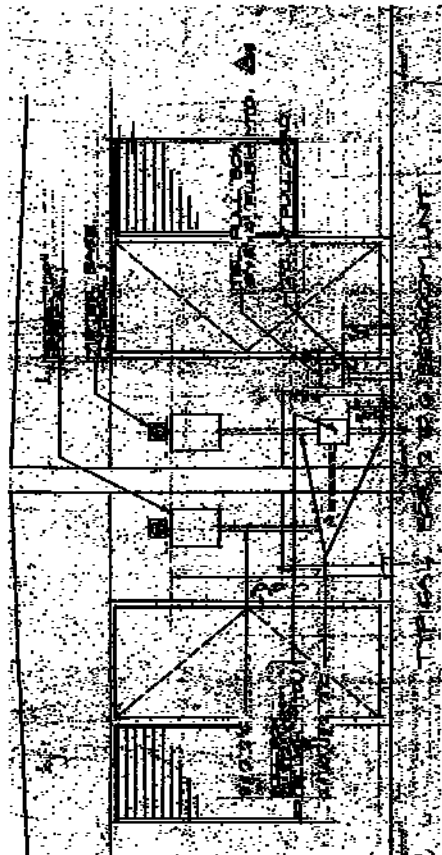

EXISTING ELECTRICAL ELEVATION (AS-BUILT)

EXISTING ELECTRICAL METER & PANEL DETAIL (AS-BUILT)

**19 MSGR JOSE LEON GUERRERO, GHURA-26 ASAN (2 bedroom)**

## GENERAL NOTES:

- Remove floor tiles throughout unit and replace all vinyl tiles. Submit sample for approval. Level floor where necessary and ensure new tiles are entirely clean (free of dust, dirt, grease) and apply 2 coats minimum of wax. Tile replacement includes stairs and stair edging.
- Perform termite treatment on unit per manufacturer's specifications. Warranty to be minimum 5 years.

## 1. KITCHEN

- A. Existing sink base cabinet to be demolished and disposed. Provide new base cabinet; base cabinet lay-out shall match existing in-kind. Submit drawings for approval.

New Base Cabinet shall consist with:

- Concrete floor base 3" thick reinforced (#3@8"O.C. each way centered)
  - Cabinet frames (vertical & horizontal) shall be 2"X2"x 11ga (.120") Steel Square tube, all joints shall be full weld primer painted gray color
  - Counter top shall be 3 layers of ½" thick cement board with Thin-set mortar (or concrete bonder) bonding between each board, ¼" stainless steel countersunk screw fastened at 12" maximum on center. Ceramic tile 12" min. and bull-nose at all edges. Submit sample for approval.
  - Cabinet side end walls shall be 2 layers of ½" thick cement board with Thin-set mortar between layers and ¼" stainless steel countersunk screw fastened at 12" maximum on center.
  - Shelves, cabinet drawers and doors shall be ¾" thick termite treated wood.
  - Replace Kitchen sink with all new accessories to include lever-type faucet.
- B. Replace wall hung cabinet to match existing in-kind. Cabinet construction shall be ¾" termite treated plyboard. Submit drawings for approval.

2. BATHROOM #2 (2<sup>nd</sup> floor)

- A. Replace shower flow control to single handle lever type. AMP to supply flow control.
- B. Retile shower walls only.

## 3. ELECTRICAL WORK REMOVAL and MODIFICATION

## 4. Others

- A. See SPECIAL CONDITIONS.

## ELECTRICAL UP-GRADE SCOPE OF WORK

1. ELECTRICAL WORK REMOVAL and MODIFICATION
  - a. Change-out existing electrical 100-amp panel box to new **125-amp** Electrical panel with new circuit breakers, contractor to field verify existing condition prior to panel removal. Contractor to comply with latest International Electrical Code. New electrical panel box shall be “recess mounted”, ensure ground wire are properly connected to new panel box, provide new directory listing of circuits.
  - b. Existing Electrical system upgrade shall consist New light fixtures, outlets and switches shall be replace with new (match in-kind). Replaced all outlet and switch covers to be flexible vinyl composition. New Light fixtures to have clear diffusers and be provided with energy star rated bulbs.
  - c. Verify existing wiring system for voltage continuity; damaged wires shall be replaced with new wires (match wire size in-kind). Surface mounted rigid conduit with new wiring to be used where necessary.
  - d. Additional circuit breakers shall be arranged equally across phase to prevent overloading any phase in the panel board. Provide new typewritten directory indicating revised equipment controlled by each circuit breaker. Touch-up repair and paint required at effected areas damaged where new work is required.

Note:

Existing Electrical Panel change out work shall be replaced with new **125-amp**, consisted of approved design drawings to accommodate construction activities associated to remove and replacement of existing electrical panel board. New panel board to accommodate existing and additional loads required. Registered Electrical Engineer shall approve design drawings. Prior to start of work the Contractor and/or Registered Electrical Engineer shall field verify and determine actual loads and field condition.

- a. IDENTIFICATION and ANALYSIS of UNCERTAINTIES; an assumption has been made that the existing electrical wires are suitable for reuse after modification/installation of new panel board. If one or more wires cannot be used as is after modification, then replacement is required. Sufficient contingency to accommodate/modification replacement shall be allocated in the contractors bid cost.
- b. Coordinate item No. 3 and 4 below for additional circuits.
- c. Contractor shall coordinate and obtained approval with Department of Public Works and Guam Power Authority necessary clearance to achieve competition under this activity.

- d. Contractor to install new grounding rod 8ft. long, ensure proper bonding to new electrical panel, connection and continuity to all outlets & light fixtures. Ensure impedance to ground is less than 25 ohms per specified in NEC 250.56.
  - e. Contractor shall obtain certified Master Electrician to verify work compliance, document, record and trace all circuits, raceways connection to all outlets, light fixtures and circuits and submit to Ghura for “AS-BUILT” record.
2. Test all electrical system to ensure all components are operational.
  3. Provide one (1) new outlet provision for Air Condition 12,000 BTU (window type) at bedrooms adjacent to existing window. New Air Condition shall consisted with separate circuit breakers 1-30amp/110-volts, #12AWS. See attached floor plan for location of new outlets.
  4. Provide one (1) new outlet provision for Air Condition 24,000BTU (window type) at Living Room with circuit breaker 1-30amp/220-volts. See attached floor plan for location of new outlet. Wires shall be #10AWS

General Notes:

1. FIELD VERIFICATION; Contractor shall field verify existing conditions, pipe inverts, dimensions prior to bidding. Contractor to notify GHURA contracting officer of any discrepancies between scope of work, actual field conditions and project intent which may interfere with this project.
2. PROTECTION: Provide temporary fences, barricades, coverings, or other protection to preserve existing items indicated to remain and to prevent injury or damage to persons or property. Provide protection for adjacent properties; restore damaged work to condition existing prior to start of work.
3. MISCELLANEOUS ITEMS of WORK not indicated but which are necessary to implement the project intent of which are customarily performed shall be provided by the Contract Bidder as if fully and correctly described in the scope of work and/or drawings. Contractor to notify GHURA official prior to commencement of work.
4. PERMITS & CLEARANCES: The contractor shall obtain building permit, coordinate and obtain Registered Licensed Engineer for preparation of Construction drawings and all necessary clearance from all Government agencies prior to any work activity within government utility side. Damaged done by the contractor to any existing GOVGUAM utility lines shall be repaired by the contractor at no cost

to the Government. Repair work shall be per the Government of Guam standards and approval.

5. ELECTRICAL WORK: All work shall under supervision of Master Electrician.
6. SHOP DRAWINGS: Prior to commencement of work, contractor to provide shop drawings for review and approval; contractor shall also provide an electronic copy.

NOTE: "The use of Lead-based both in Paint or Solder is prohibited."  
\*\*\*End of Special Conditions\*\*

# GHURA 26

ASAN

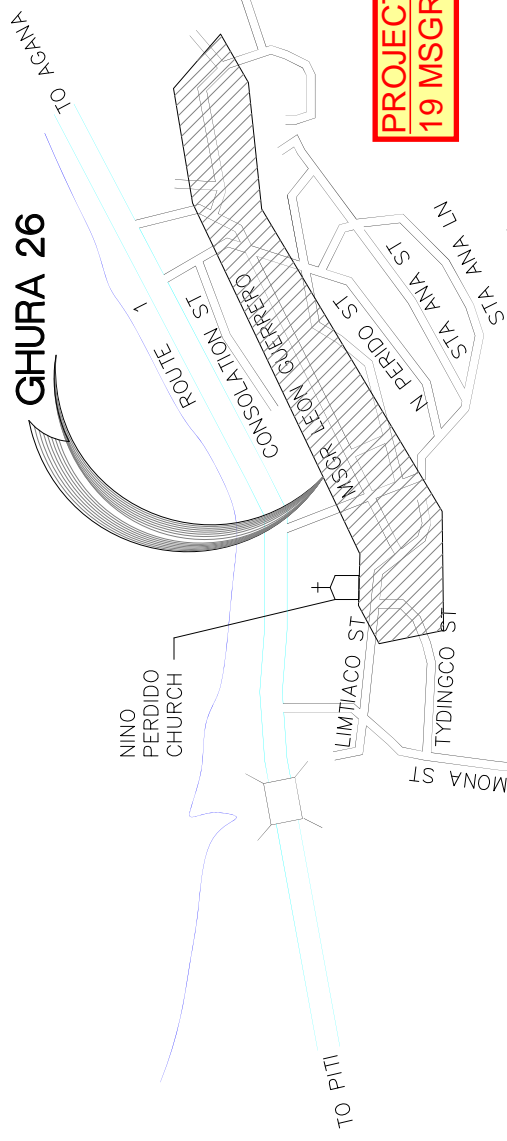

**PROJECT LOCATION  
19 MSGR (2BDRM)**

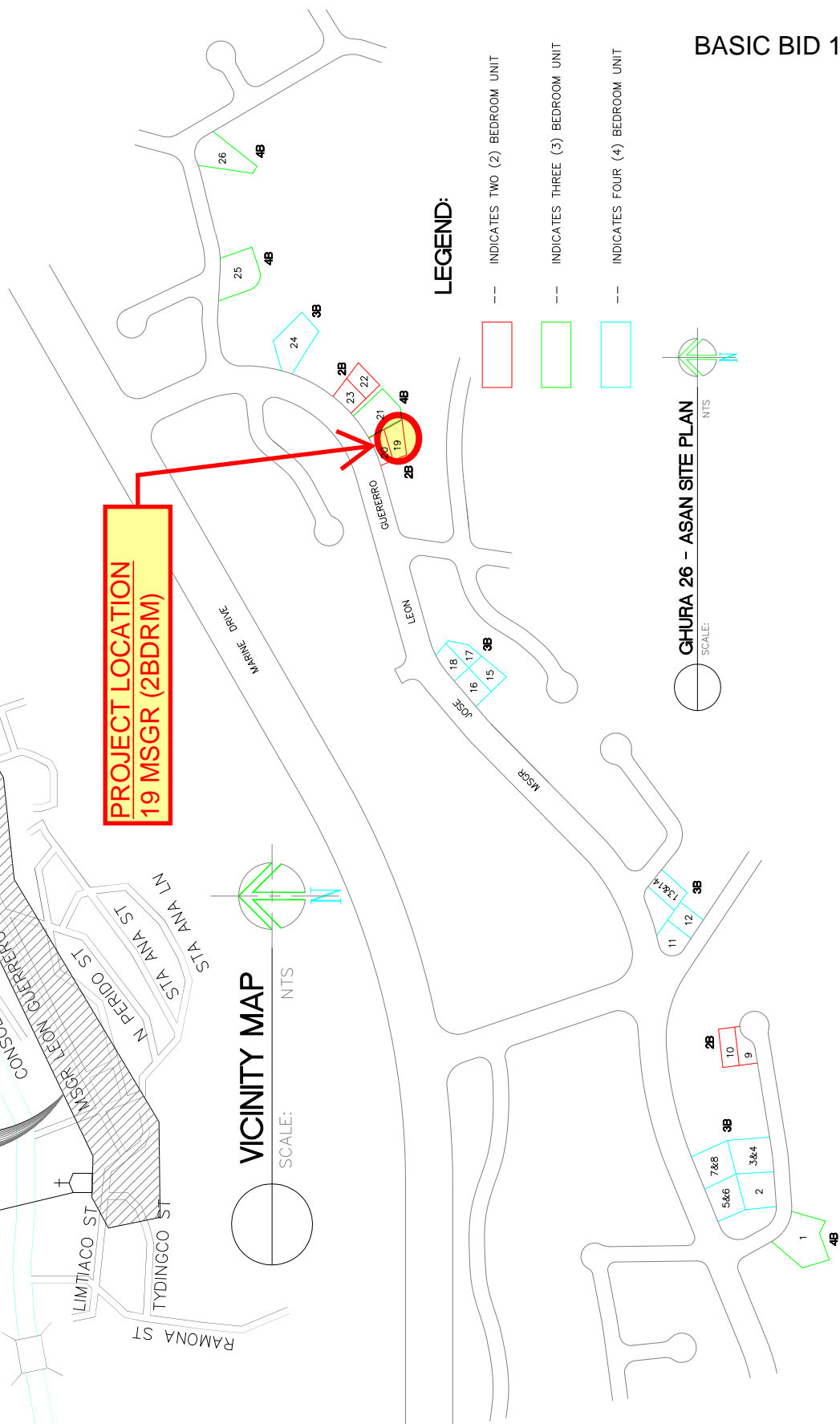
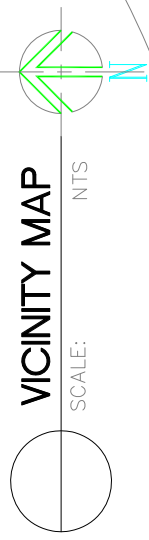

BASIC BID 1

AS-BUILT

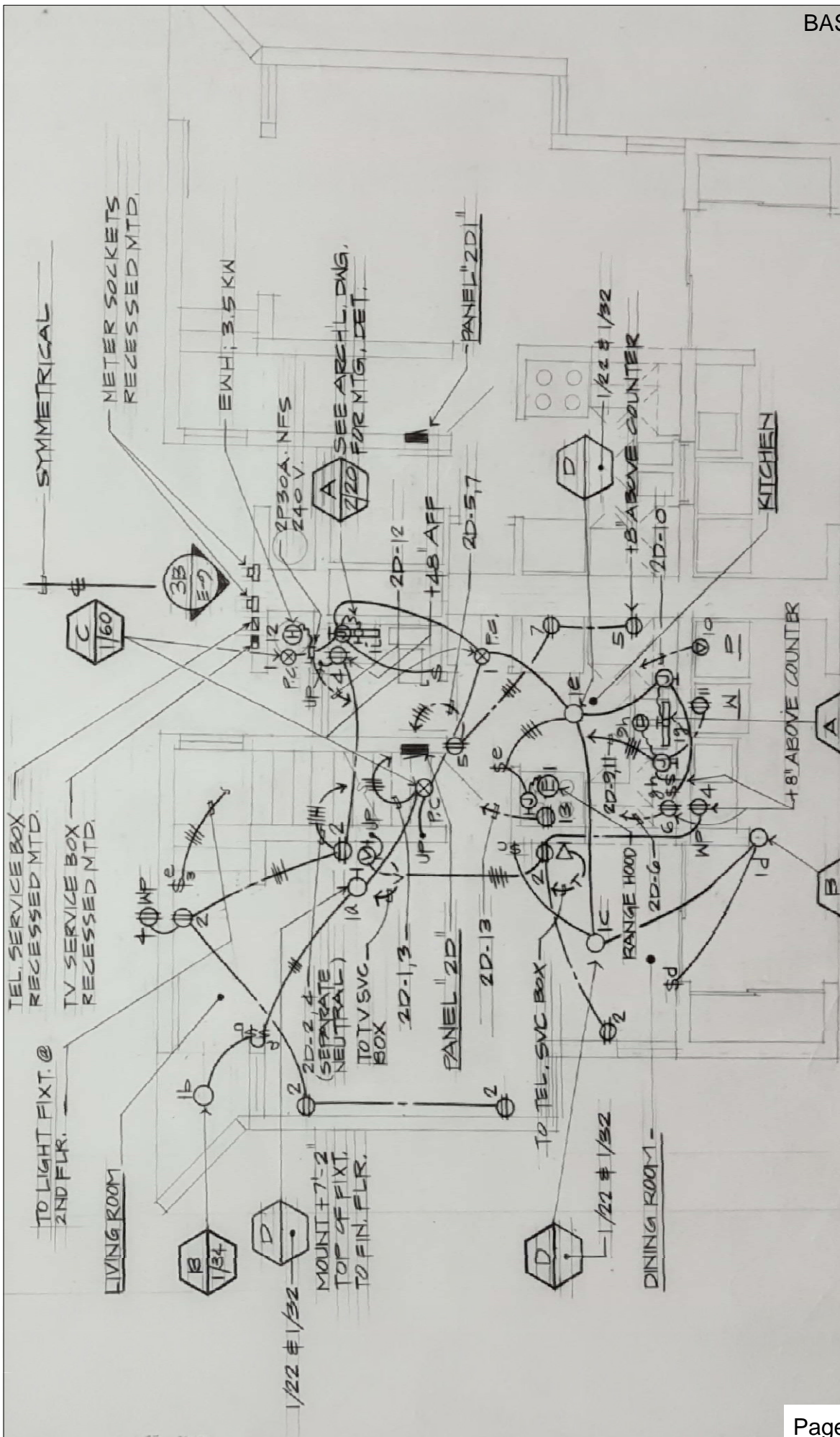

1 FIRST FLOOR ELECTRICAL PLAN (2 BEDROOM - DUPLEX) SCALE: 1/4" = 1'-0"



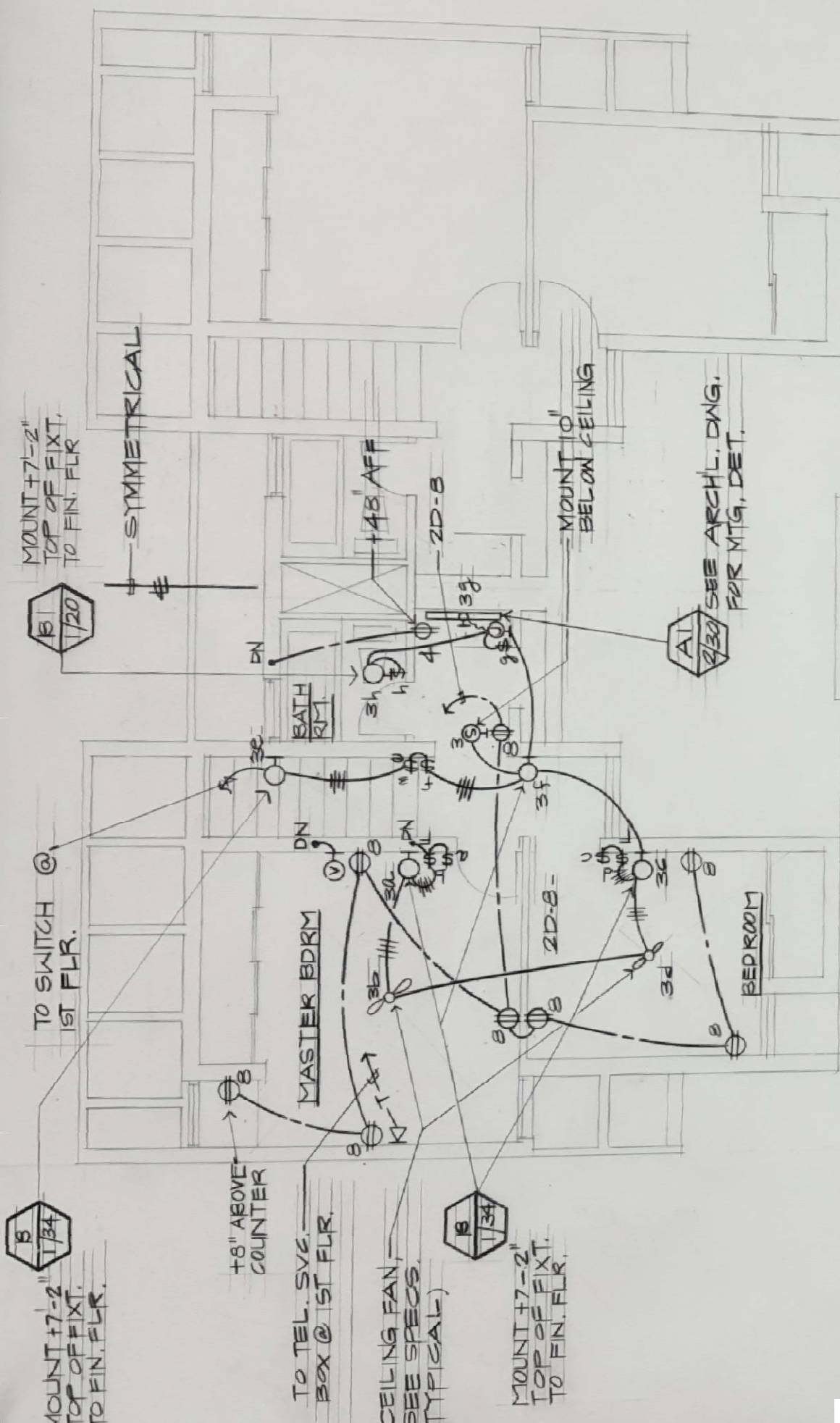

AS-BUILT

2 SECOND FLOOR ELECTRICAL PLAN  
 (2 BEDROOM-DUPLEX)  
 SCALE: 1/4" = 1'-0"

**9A CALLE DAMIAN, GHURA-250 TOTO (4 bedroom)**

## GENERAL NOTES:

- See SPECIAL CONDITIONS for front and rear and EXTERIOR door replacement. Exterior storage doors to be replaced also w/ 1ea 36" aluminum door centered with ½" cement board on metal frame (or CMU equivalent) in-fill on sides. Locksets are to be universally keyed (one key fits all)
  - Keyed locksets and deadbolts in good condition to be given (w/ keys) to AMP management for re-use.
  - Remove floor tiles throughout unit and replace all vinyl tiles. Submit sample for approval. Level floor where necessary and ensure new tiles are entirely clean (free of dust, dirt, grease) and apply 2 coats minimum of wax. Caulk tile edging at walls.
1. KITCHEN
    - A. Existing base cabinets (both) to be demolished and disposed. Provide new base cabinets; base cabinet lay-out shall match existing in-kind, except that sink cabinet/counter shall have 36" clearance from left wall. Submit drawings for approval. New Base Cabinet shall consist with:
      - Concrete floor base 3" thick reinforced (#3@8"O.C. each way centered)
      - Cabinet frames (vertical & horizontal) shall be 2"x2"x 11ga (.120") Steel Square Tube, all joints shall be full weld primer painted gray color
      - Counter top shall be 3 layers of ½" thick cement board with Thin-set mortar bonding between each board, ¼" stainless steel countersunk screw fastened at 12" maximum on center. Ceramic tile 12" min. and bull-nose at all edges. Submit sample for approval.
      - Cabinet side end walls shall be 2 layers of ½" thick cement board with Thin-set mortar between layers and ¼" stainless steel countersunk screw fastened at 12" maximum on center.
      - Shelves, cabinet drawers and doors shall be ¾" thick termite treated wood.
      - Replace Kitchen sink with all new accessories to include lever-type faucet. Kitchen drain replacement to include wall nipple.
  2. EXTERIOR
    - A. Provide new stainless steel wire #9 gauge 25LFx4 for clotheslines
    - B. Provide new water shut-off (ball valve) 6" after main water meter box with appropriate encasement.
    - C. Demolish and remove utility sink and counter. Install free standing fiberglass utility sink to be secured to deck and wall. Eliminate and cap-off old laundry drain.
  3. Electrical work removal and modification
    - A. Electrical system to be up-graded based on most current international Electrical Code.

- B. Existing Electrical system up-grade shall consist of new light fixtures, outlets and switches throughout unit..
  - C. Existing wiring to be used where feasible. Surface mounted rigid conduit with new wiring to be used where necessary.
  - D. Existing electrical system panel box to be remove completely and replace with new Panel box.
  - E. See attached work scope for further details
4. See SPECIAL CONDITIONS

## ELECTRICAL UP-GRADE SCOPE OF WORK

1. ELECTRICAL WORK REMOVAL and MODIFICATION
  - a. Change-out existing electrical 100-amp panel box to new 150-amp Electrical panel with new circuit breakers, contractor to field verify existing condition prior to panel removal. Contractor to comply with latest International Electrical Code. New electrical panel box shall be “recess mounted”, ensure ground wire are properly connected to new panel box, provide new directory listing of circuits.
  - b. Existing Electrical system upgrade shall consist New light fixtures, outlets and switches shall be replace with new (match in-kind). Replaced all outlet and switch covers to be flexible vinyl composition. New Light fixtures to have clear diffusers and be provided with energy star rated bulbs.
  - c. Verify existing wiring system for voltage continuity; damaged wires shall be replaced with new wires (match wire size in-kind). Surface mounted rigid conduit with new wiring to be used where necessary.
  - d. Additional circuit breakers shall be arranged equally across phase to prevent overloading any phase in the panel board. Provide new typewritten directory indicating revised equipment controlled by each circuit breaker. Touch-up repair and paint required at effected areas damaged where new work is required.

Note:

Existing Electrical Panel change out work shall be replaced with new **150-amp**, consisted of approved design drawings to accommodate construction activities associated to remove and replacement of existing electrical panel board. New panel board to accommodate existing and additional loads required. Registered Electrical Engineer shall approve design drawings. Prior to start of work the Contractor and/or Registered Electrical Engineer shall field verify and determine actual loads and field condition.

- a. IDENTIFICATION and ANALYSIS of UNCERTAINTIES; an assumption has been made that the existing electrical wires are suitable for reuse after modification/installation of new panel board. If one or more wires cannot be used as is after modification, then replacement is required. Sufficient contingency to accommodate/modification replacement shall be allocated in the contractors bid cost.
- b. Coordinate item No. 3 and 4 below for additional circuits.
- c. Contractor shall coordinate and obtained approval with Department of Public Works and Guam Power Authority necessary clearance to achieve competition under this activity.

- d. Contractor to install new grounding rod 8ft. long, ensure proper bonding to new electrical panel, connection and continuity to all outlets & light fixtures. Ensure impedance to ground is less than 25 ohms per specified in NEC 250.56.
  - e. Contractor shall obtain certified Master Electrician to verify work compliance, document, record and trace all circuits, raceways connection to all outlets, light fixtures and circuits and submit to Ghura for “AS-BUILT” record.
2. Test all electrical system to ensure all components are operational.
  3. Provide one (1) new outlet provision for Air Condition 12,000 BTU (window type) at bedrooms adjacent to existing window. New Air Condition shall consisted with separate circuit breakers 1-30amp/110-volts, #12AWS. See attached floor plan for location of new outlets.
  4. Provide one (1) new outlet provision for Air Condition 24,000BTU (window type) at Living Room with circuit breaker 1-30amp/220-volts. See attached floor plan for location of new outlet.
  5. Existing Water Heater replace exist. safety disconnect box with new, match in-kind, see attached FLOOR PLAN for location.

General Notes:

1. FIELD VERIFICATION; Contractor shall field verify existing conditions, pipe inverts, dimensions prior to bidding. Contractor to notify GHURA contracting officer of any discrepancies between scope of work, actual field conditions and project intent which may interfere with this project.
2. PROTECTION: Provide temporary fences, barricades, coverings, or other protection to preserve existing items indicated to remain and to prevent injury or damage to persons or property. Provide protection for adjacent properties; restore damaged work to condition existing prior to start of work.
3. MISCELLANEOUS ITEMS of WORK not indicated but which are necessary to implement the project intent of which are customarily performed shall be provided by the Contract Bidder as if fully and correctly described in the scope of work and/or drawings. Contractor to notify GHURA official prior to commencement of work.
4. PERMITS & CLEARANCES: The contractor shall obtain building permit, coordinate and obtain Registered Licensed Engineer for preparation of Construction drawings and all necessary clearance from all Government agencies prior to any work activity within government utility side. Damaged done by the contractor to any existing GOVGUAM utility lines shall be repaired by the contractor at no cost

to the Government. Repair work shall be per the Government of Guam standards and approval.

5. ELECTRICAL WORK: All work shall under supervision of Master Electrician.
6. SHOP DRAWINGS: Prior to commencement of work, contractor to provide shop drawings for review and approval; contractor shall also provide an electronic copy.

NOTE: "The use of Lead-based both in Paint or Solder is prohibited."  
\*\*\*End of Special Conditions\*\*

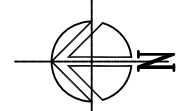

GHURA 250 - TOTO SITE PLAN

NTS

AMP 4

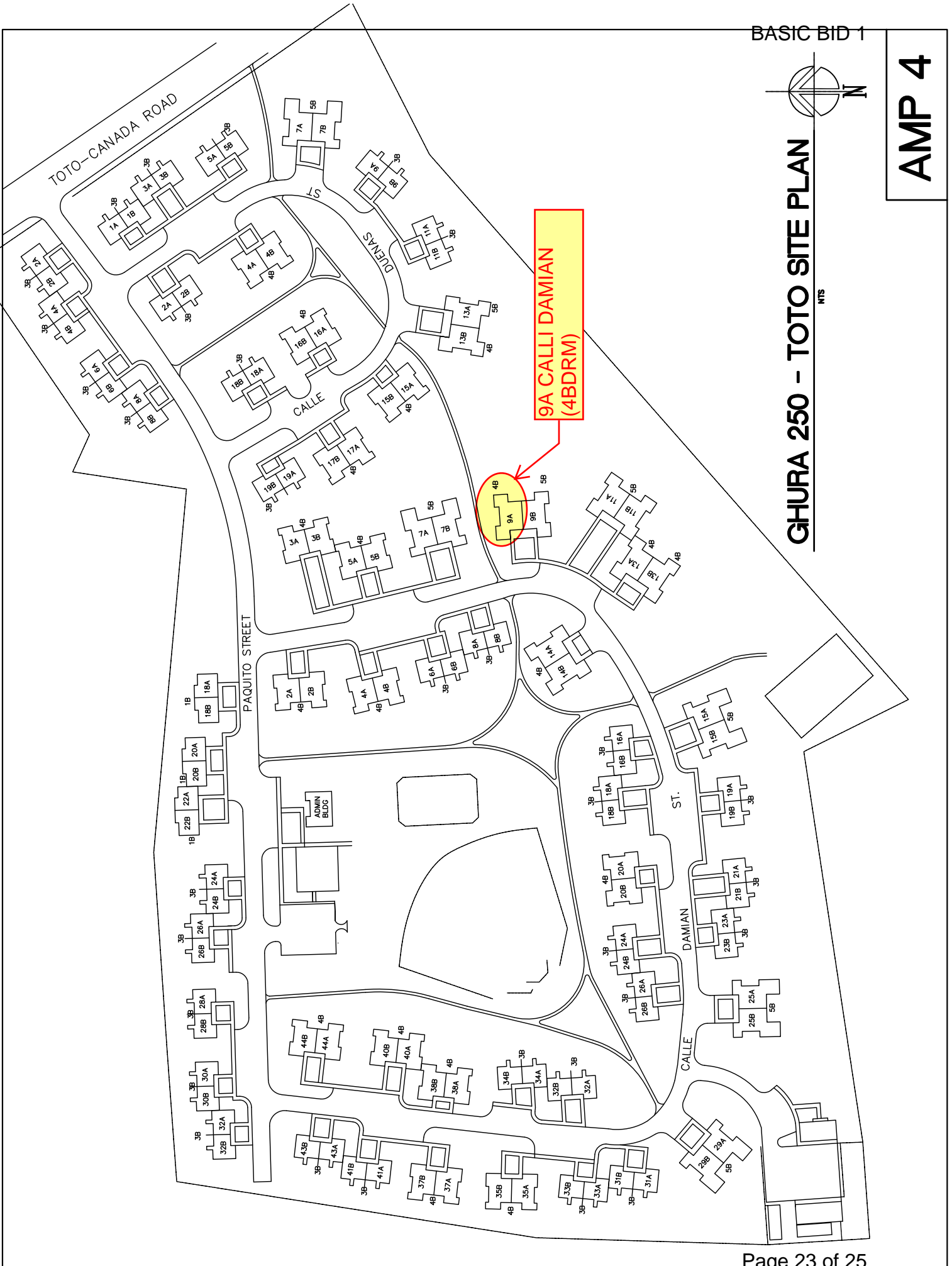

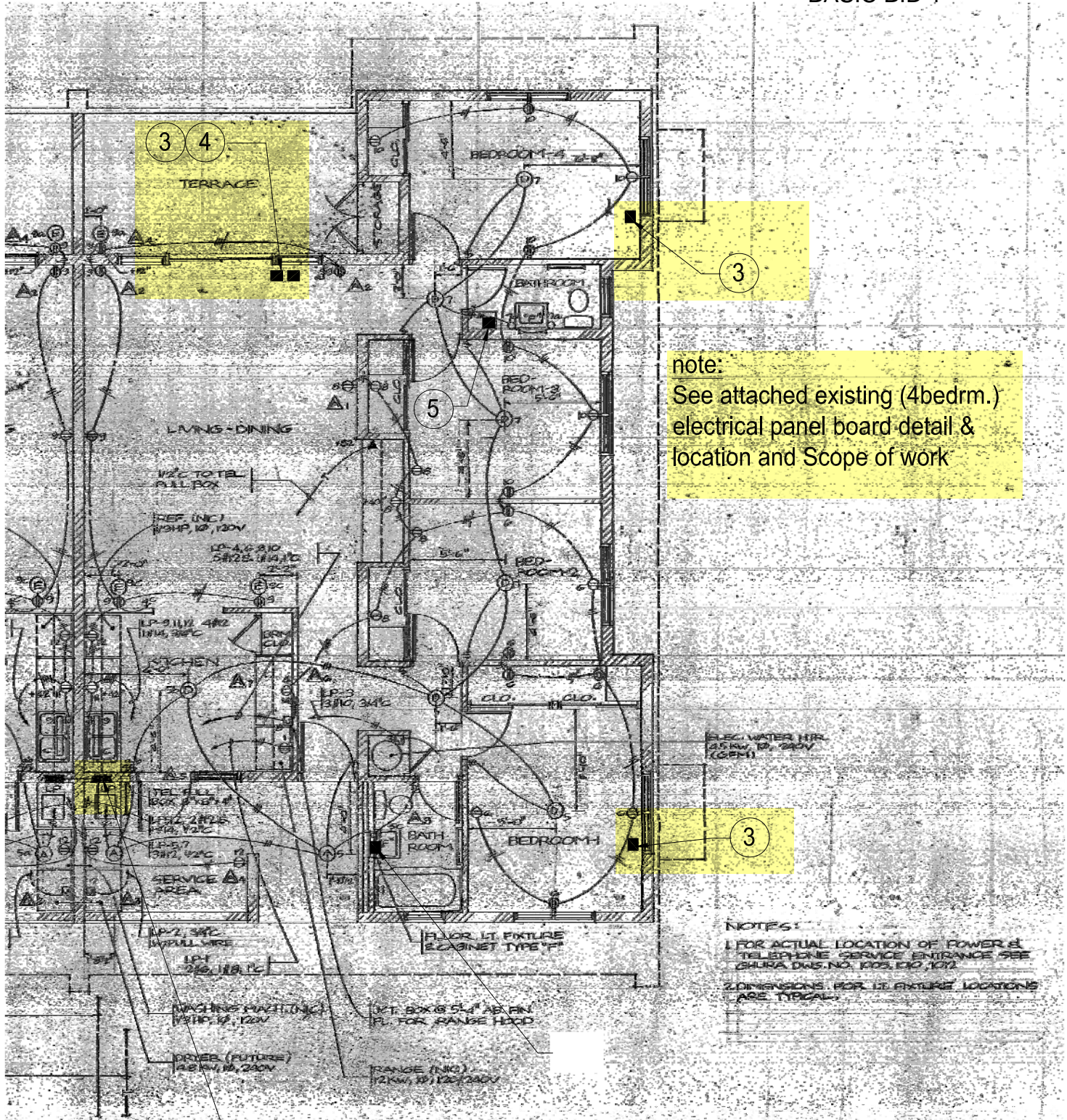

1 2

**LEGEND:**

1 - SCOPE OF WORK DESIGNATION NUMBER

**4 BEDROOM ELECTRICAL FLOOR PLAN (AS-BUILT)**



EXISTING ELECTRICAL PANEL - 4 BEDROOM (AS-BUILT)

DESCRIPTION	2250	#10 20A	3	4	20A #12	1800	KITCHEN
(ELEC. WATER HEAT.)	2250						
BEDROOM	500	#12 20A	5	6	#12	1840	BEDROOM 1, 2, 3, 4
BATH	460		7	8		1100	BEDROOM 1, 2, 3, 4, BATH
TERR. LIVING-DINING	1600		9	10		1200	BEDROOM 1, 2, 3, 4, CLO.
KITCHEN			11	12		1920	KITCHEN, SERV. AREA
TOTAL PANEL LOAD							
TOTAL PANEL LOAD							
TOTAL CONNECTED LOAD							
TOTAL DEMAND LOAD							

MAINS 2P 100AFC 100AFC CB

SCALE NONE

2 PANEL BOARD LOAD SCHEDULE

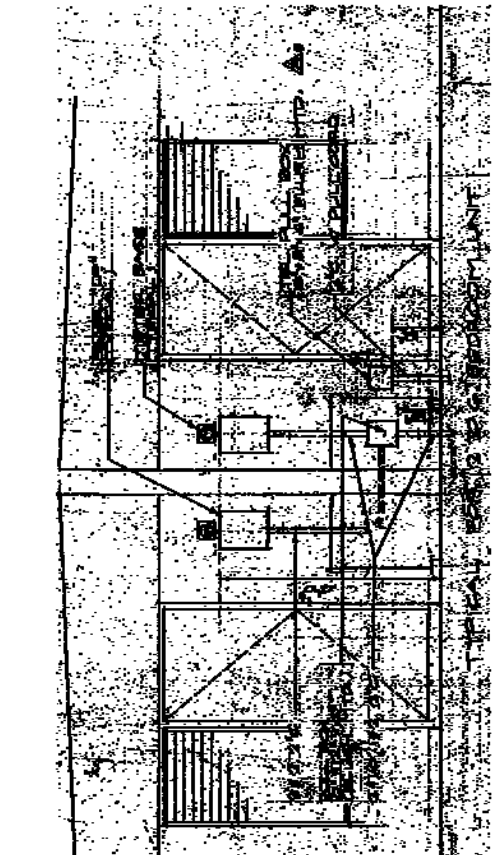
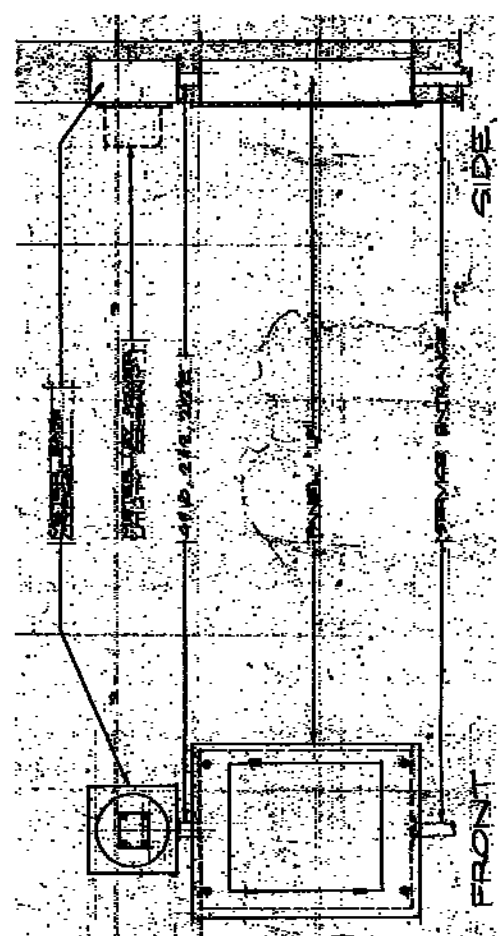

EXISTING ELECTRICAL PANEL DETAIL (AS-BUILT)

EXISTING ELECTRICAL ELEVATION (AS-BUILT)

EXISTING ELECTRICAL METER & PANEL DETAIL (AS-BUILT)

# BASIC BID 2

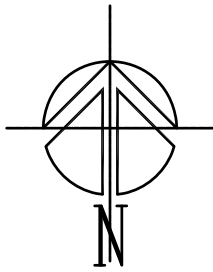

PHILIPPINE  
SEA

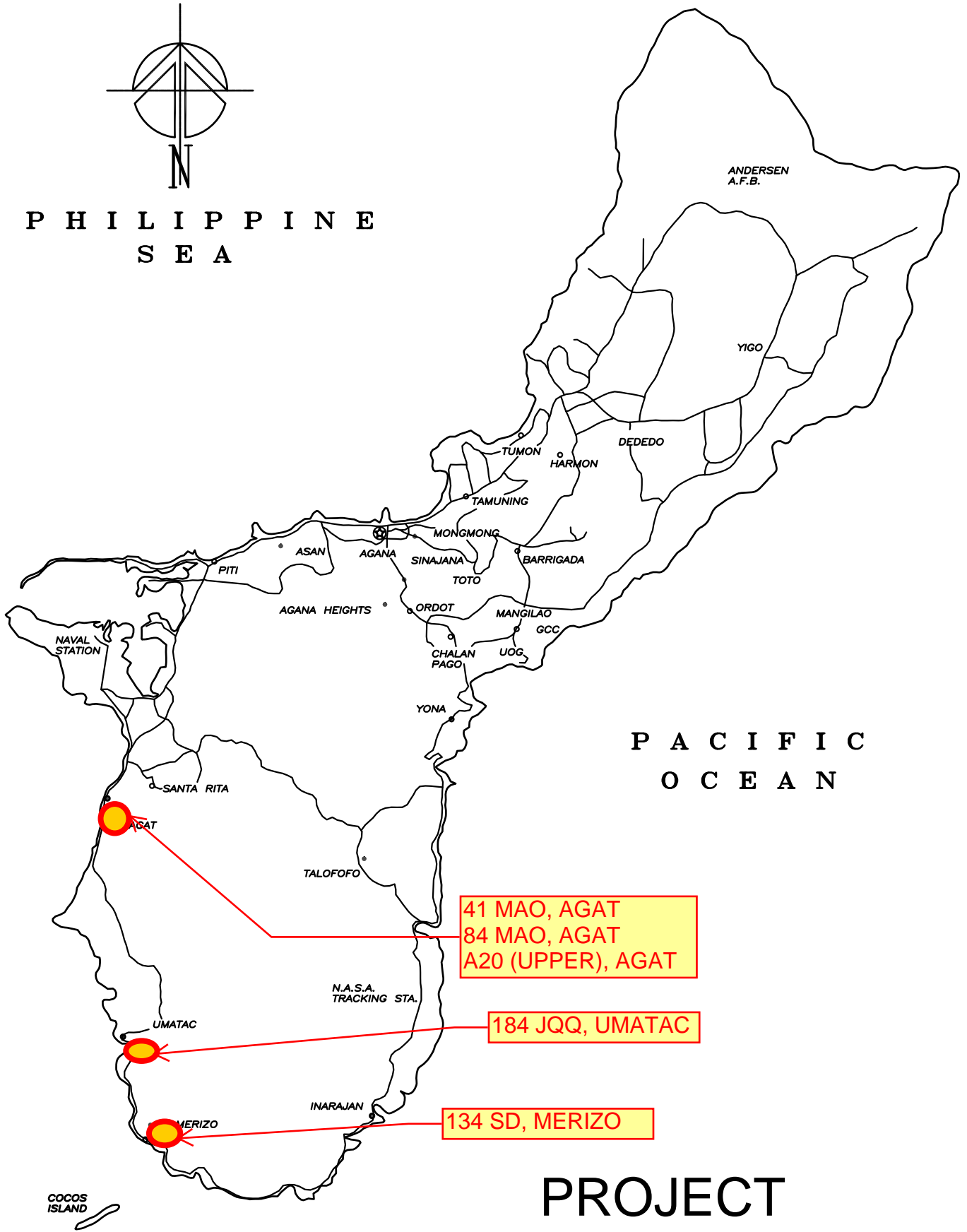

41 MAO, AGAT  
84 MAO, AGAT  
A20 (UPPER), AGAT

184 JQQ, UMATAC

134 SD, MERIZO

PACIFIC  
OCEAN

# PROJECT LOCATION MAP

## SCOPE OF WORK

### 41 MAO DR., GH-99, AGAT (3 Bedroom)

- See SPECIAL CONDITIONS for PAINTING. Work to include scraping of ceiling surfaces  
Paint codes: Walls=SW1095, Ceiling=SW1004, Wood and trim=SW6069
- See SPECIAL CONDITIONS for exterior door replacements. Doors to be replaced to aluminum with screens: 1ea 36" front entrance; 1ea 36" rear entrance; 1ea 32" Kitchen entrance. Doors to be replaced to aluminum without screens: 1ea 28" water heater closet and 2ea 32" front storage closets. (Water heater door shall have venting).
- Remove and replace all vinyl tiles with similar type. Prior to installation of new vinyl tiles, patch all uneven surfaces. Ensure tiles are entirely cleaned and free of dirt, dust, grease and apply 2 coats minimum of wax.
- All cove base and adhesive to be removed throughout unit. Provide continuous caulking at floor/wall corner and paint 4" high trim throughout.
- Existing interior waste lines at Bathrooms to be completely removed and disposed. Provide new PVC waste lines and connect to existing vents. New waste line replacement shall consist of approved assigned drawings by Registered Engineer and contractor to submit all documents required prior to start of work. Waste line replacement will include patch and touch-up paint at waste line entry points on walls. Other existing items damaged incidental with construction activities shall be repaired by the contractor at no additional cost to GHURA.
- Unit to be termite treated (5 year minimum warranty)
- Replace all light switch and outlet covers to flexible vinyl type
- Replace exterior light fixtures. ALL light fixtures to be installed with Energy star rated bulbs.
- All interior locksets to be replaced to lever-type.
- Clerestory opening above bedrooms and above bathroom entries to provide new ½" cement board wall infill on metal frame. Vertical frame @ 12" O.C. with top and bottom metal runner. See locations (A) on FLOOR PLAN.

\*\*\*SEE FLOOR PLAN FOR BEDROOM NUMBERING

#### 1. KITCHEN

- A. Existing base cabinet to be demolished and disposed. Provide new base cabinet; base cabinet lay-out shall match existing in-kind.

New Base Cabinet shall consist with:

- Concrete floor base 3" thick reinforced (#3@8"O.C. each way centered)
- Cabinet frames (vertical & horizontal) shall be 2"x2"x 11ga (.120") Steel Square Tube, all joints shall be full weld primer painted (gray color).
- Counter top shall be 3 layers of ½" thick cement board with Thin-set mortar bonding between each board, ¼" stainless steel countersunk screw fastened at

12" maximum on center. Ceramic tile 12" min. and bull-nose at all edges.  
Submit sample for approval.

- Cabinet side end walls shall be 2 layers of ½" thick cement board with Thin-set mortar between layers and ¼" stainless steel countersunk screw fastened at 12" maximum on center.
  - Shelves, cabinet drawers and doors shall be ¾" thick termite treated wood.
- B. Replace Kitchen sink with new accessories to include lever-type faucet, ½" supply lines and ½' x ½" angle valves.
  - C. Refurbish upper cabinets.
  - D. Replace range hood assembly.

## 2. LIVING ROOM

- A. Provide 1ea permanent mount window locking mechanism.
- B. Remove closet doors. DO NOT REPLACE DOORS. Remove hardware, fill, sand, and paint jambs to remove any evidence of previous door installation.

## 3. BATHROOMS (BOTH)

- A. Refurbish doors and jambs
- B. Replace medicine cabinets ,shower curtain rods, tissue holders, and towel racks
- C. Replace sinks with accessories to include ½" supply lines and ½" x ½" angle valves.  
Faucets to be lever-type non-corrodible metal
- D. Replace toilets with new accessories to include ½" supply lines and ½' x ½" angle valves.
- E. Provide permanent mount window locking mechanism (Master Bathroom only)

## 4. HALLWAY

- A. Replace 2ea closet doors to SCD with new hardware.

## 5. BEDROOM #1

- A. Replace door to SCD with new hardware
- B. Provide permanent-mount window locking mechanism.
- C. Refurbish closet door jambs

## 6. BEDROOM #2

- A. Replace door to SCD with new hardware
- B. Remove closet door. DO NOT REPLACE DOOR. Remove hardware, fill, sand, and paint jamb to remove any evidence of m previous door installation.
- C. Refurbish closet door jambs

## 7. BEDROOM #3

- A. Replace door to SCD with new hardware
- B. Provide permanent-mount window locking mechanism

8. OTHER
  - A. Trim mango tree at rear of unit.
  - B. See SPECIAL CONDITIONS

**PLUMBING NOTES (NEW WORK)****NOTES:**

1. Contractor shall field verify existing condition & dimensions prior to bidding. Contractor to notify contracting officer for any discrepancies between scope of work, actual field conditions and project intent which may interfere with this project.
2. Miscellaneous items of work not indicated but which are necessary to implement the project intent of which are customarily performed shall be provided by the Contract Bidder as if fully and correctly described in the scope of work and/or drawings.
3. ALL PLUMBING WORKS SHALL CONFORM TO THE UNIFORM PLUMBING CODE LATEST EDITION, THE CONTRACT DOCUMENTS AND REGULATIONS OF THE GOVERNMENT OF GUAM.
4. NO PIPING SYSTEM SHALL BE BURIED OR CONCEALED UNTIL INSPECTED, TESTED AND ACCEPTED BY GHURA. ALL PIPING SHALL BE TESTED FOR LEAKAGE.
5. ALL EXISTING WAISTLINE TO BE REMOVE AND DISPOSED SHALL BE IN ACCORDANCE W/ GUAM ENVIRONMENTAL PROTECTION AGENCY (GEPA).
6. ALL HORIZONTAL VENT LOOP SHALL BE SLOPED SO AS TO ALLOW MOISTURE TO DRAIN BACK TO WASTE PIPE.
7. ALL WASTE LINES OR PIPING SHALL HAVE A SLOPE OF 1/4" PER FOOT. PIPE TRENCHES SUB-BASE GRADE SHALL BE 90% COMPACTED TO AVOID PIPE MISSALIGNMENT.
8. NEW WASTE LAYOUT BENDS SHALL CONSISTED WITH LONG RADIUS BENDS (UNLESS NOTED OTHERWISE), EXTERIOR WASTE LINES SHALL BE 36" MIN. AWAY FROM BUILDING WALL FOOTINGS.
9. PROVIDE PIPE SLEEVES FOR PIPES PASSING THRU WALLS AND FOUNDATIONS.
10. ALL GROUND CLEANOUTS (GCO) SHALL BE PROVIDED WITH 12"x12"x4" THK CONCRETE COLLAR. GCO SPACING SHALL NOT BE MORE THAN 50'-0" APART.
11. ALL EXISTING VENT-THRU-ROOF'S (VTR) TO REMAIN UNLESS NOTED OTHERWISE, NEW WASTELINE CONNECT EXISTING WASTELINE FOR VTR.
12. CONTRACTOR TO TEST ALL PIPING PRIOR TO COVERING.
13. ALL SLABS, WALLS AND WALL FOOTINGS TO BE DEMO DUE EXISTING WAISTLINE REPLACEMENT SHALL BE REPAIR & RESTORE TO ORIGINAL CONDITION. DO NOT CUT EXIST. BARS. NEW CONCRETE 3000psi min.
14. SEWER WASTE LINES SHOWN WERE BASED ON AVAILABLE DOCUMENTS PROVIDED BY GHURA AND ARE APPROXIMATE LOCATIONS ONLY. PRIOR TO THE START OF CONSTRUCTION THE CONTRACTOR SHALL FIELD VERIFY ACTUAL LOCATIONS AND SHALL IMMEDIATELY NOTIFY GHURA OF ANY DISCREPANCIES BETWEEN THE PLANS FOR THIS PROJECT AND ACTUAL FIELD CONDITIONS WHICH MAY INTERFERE WITH THIS PROJECT.
15. THE CONTRACTOR SHALL MAKE CONNECTIONS TO EXISTING SEWER LATERAL IN ALL APPROVED MANNER AND DO SO WITH MINIMUM INTERRUPTION OF SERVICE.

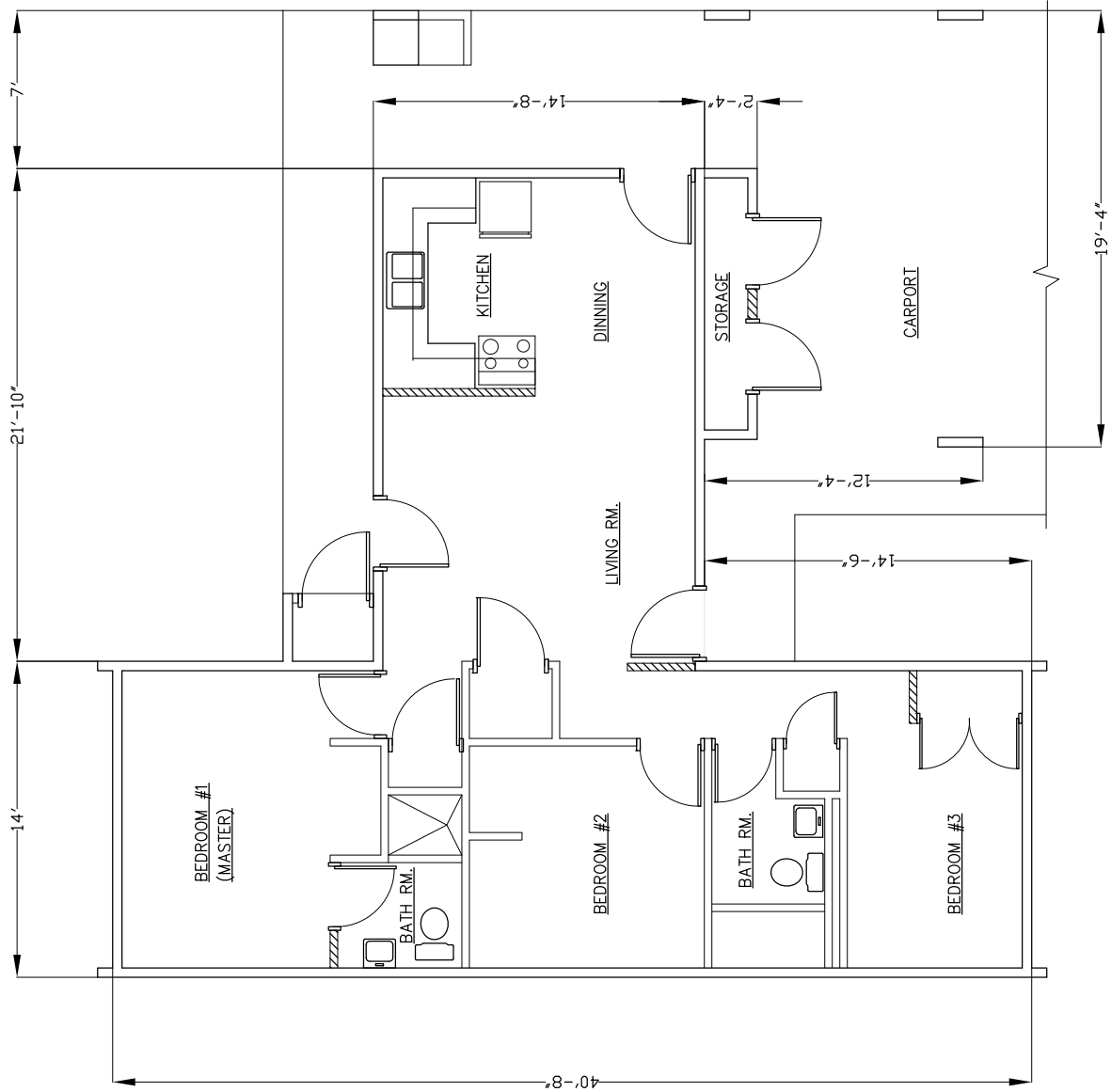

# GH-99, 3-BEDROOM



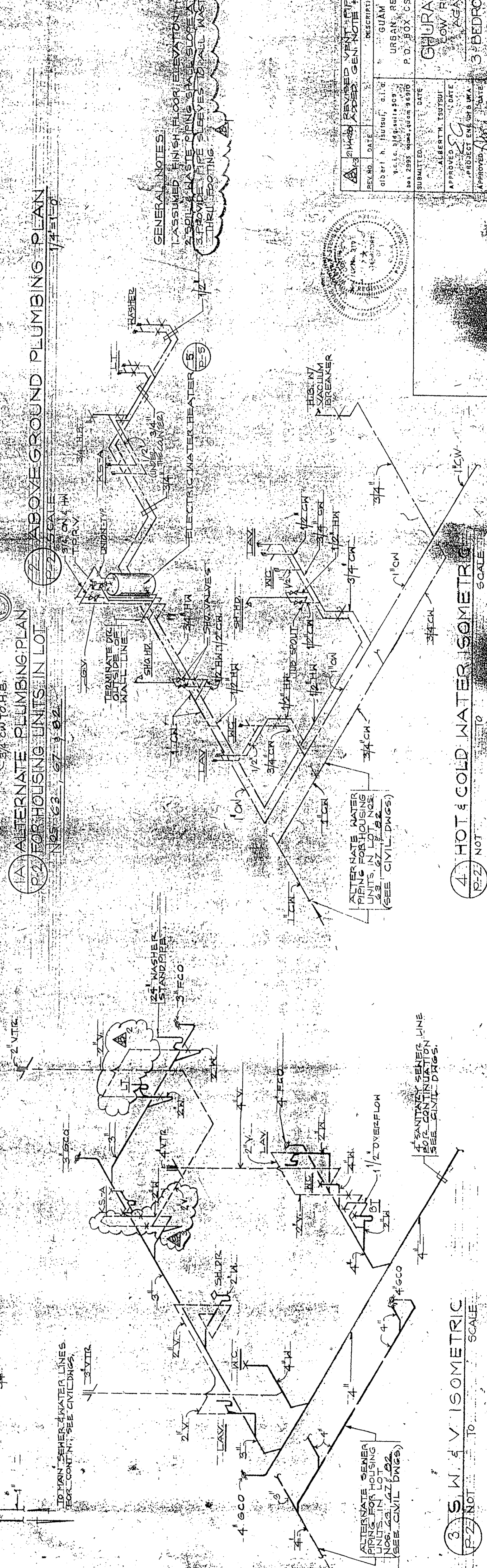
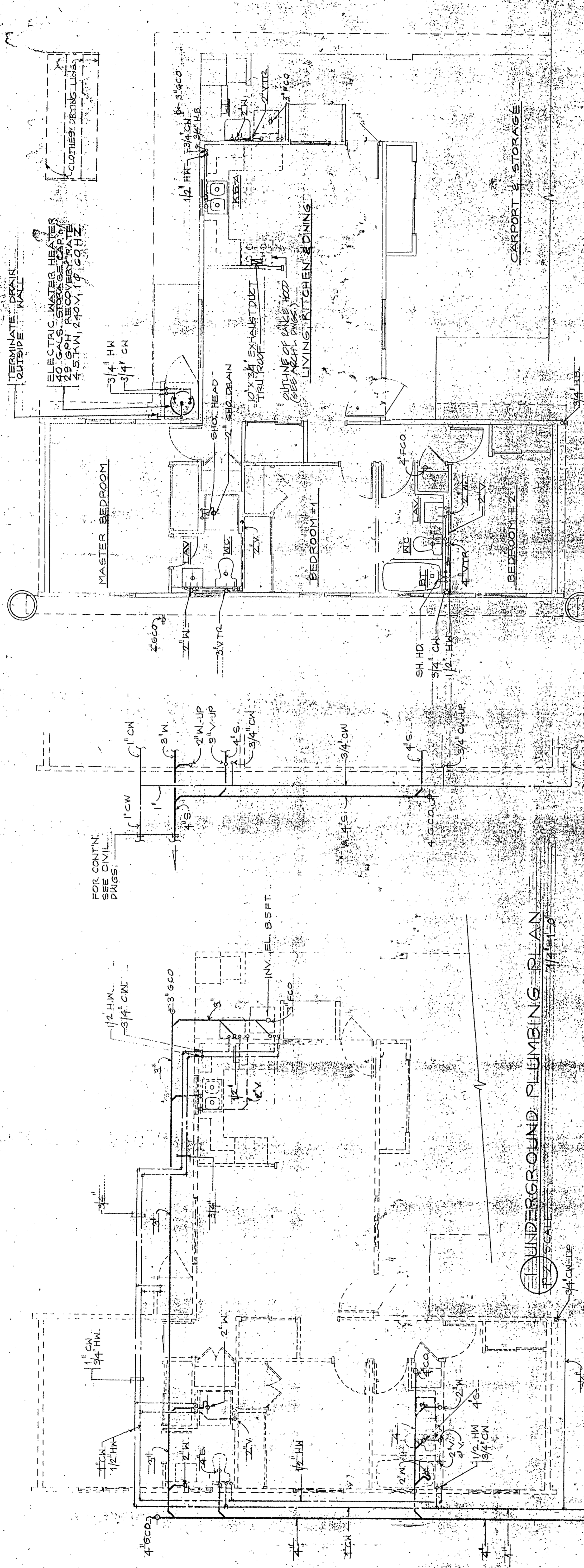

GENERAL NOTES:  
 1. ASSUMED FINISH FLOOR ELEVATION IS 0.00 FT.  
 2. SOIL & WASTE PIPING SHALL BE A MIN. OF 14\"/>



REV. NO.	DATE	DESCRIPTION
1		REVISED VENT PIPING
2		GEN. NOTE #3

DESIGNED BY: ALBERT T. TSUTSUI, P.E.  
 PROJECT NO.: 1000  
 PROJECT NAME: 3-BEDROOM PLUMBING PLAN / DETAIL  
 CLIENT: CHURA HOUSING UNIT  
 ADDRESS: LOW RENT HOUSING, AGAT, GUAM  
 P.O. BOX: CS, AGANA, GUAM

DATE: 7/21/19  
 SCALE: AS SHOWN

3. S.W. & V. ISOMETRIC SCALE 1/4\"/>

4. HOT & COLD WATER ISOMETRIC SCALE 1/4\"/>

1A. ALTERNATE PLUMBING PLAN FOR HOUSING UNITS IN LOT NOS. 63, 67 & 82

FOR CONTN. SEE CIVIL DWGS.

## SCOPE OF WORK

### 84 MAO DR., GH-99, AGAT (2 Bedroom)

- See SPECIAL CONDITIONS for exterior door replacements. Doors to be replaced to aluminum with screens: 1ea 36" front entrance; 1ea 36" rear entrance; Doors to be replaced to aluminum without screens: 1ea 28" water heater closet and 2ea 32" front storage closets. (Water heater door shall have venting).
- Existing interior and exterior waste line to be completely removed and disposed. Provide new PVC waste line system. Existing vents to remain and reconnected to new system. New waste line replacement shall consist of approved assigned drawings by Registered Engineer and contractor to submit all documents required prior to start of work. Waste line replacement will include patch and touch-up paint at waste line entry points on walls. Other existing items damaged incidental with construction activities shall be repaired by the contractor at no additional cost to GHURA.

#### 1. KITCHEN

- Existing cabinets to be demolished and disposed. Provide new base cabinet; base cabinet lay-out shall match existing in-kind.  
New Base Cabinet shall consist with:
  - Concrete floor base 3" thick reinforced (#3@8"O.C. each way centered)
  - Cabinet frames (vertical & horizontal) shall be 2"X2"x 11ga (.120") Steel Square Tube, all joints shall be full weld primer painted (gray color).
  - Counter top shall be 3 layers of ½" thick cement board with Thin-set mortar bonding between each board, ¼" stainless steel countersunk screw fastened at 12" maximum on center. Ceramic tile 12" min. and bull-nose at all edges. Submit sample for approval.
  - Cabinet side end walls shall be 2 layers of ½" thick cement board with Thin-set mortar between layers and ¼" stainless steel countersunk screw fastened at 12" maximum on center.
  - Shelves, cabinet drawers and doors shall be ¾" thick termite treated wood.
  - Replace Kitchen sink with new accessories to include lever-type faucet, ½" supply lines and ½' x ½" angle valves.
  - Wall hung cabinets to be replaced with existing in-kind composed entirely of ¾" termite treated wood.
  - Submit drawings for approval.

#### 2. OTHER

- A. See SPECIAL CONDITIONS

**PLUMBING NOTES (NEW WORK)****NOTES:**

1. Contractor shall field verify existing condition & dimensions prior to bidding. Contractor to notify contracting officer for any discrepancies between scope of work, actual field conditions and project intent which may interfere with this project.
2. Miscellaneous items of work not indicated but which are necessary to implement the project intent of which are customarily performed shall be provided by the Contract Bidder as if fully and correctly described in the scope of work and/or drawings.
3. ALL PLUMBING WORKS SHALL CONFORM TO THE UNIFORM PLUMBING CODE LATEST EDITION, THE CONTRACT DOCUMENTS AND REGULATIONS OF THE GOVERNMENT OF GUAM.
4. NO PIPING SYSTEM SHALL BE BURIED OR CONCEALED UNTIL INSPECTED, TESTED AND ACCEPTED BY GHURA. ALL PIPING SHALL BE TESTED FOR LEAKAGE.
5. ALL EXISTING WAISTLINE TO BE REMOVE AND DISPOSED SHALL BE IN ACCORDANCE W/ GUAM ENVIRONMENTAL PROTECTION AGENCY (GEPA).
6. ALL HORIZONTAL VENT LOOP SHALL BE SLOPED SO AS TO ALLOW MOISTURE TO DRAIN BACK TO WASTE PIPE.
7. ALL WASTE LINES OR PIPING SHALL HAVE A SLOPE OF 1/4" PER FOOT. PIPE TRENCHES SUB-BASE GRADE SHALL BE 90% COMPACTED TO AVOID PIPE MISSALIGNMENT.
8. NEW WASTE LAYOUT BENDS SHALL CONSISTED WITH LONG RADIUS BENDS (UNLESS NOTED OTHERWISE), EXTERIOR WASTE LINES SHALL BE 36" MIN. AWAY FROM BUILDING WALL FOOTINGS.
9. PROVIDE PIPE SLEEVES FOR PIPES PASSING THRU WALLS AND FOUNDATIONS.
10. ALL GROUND CLEANOUTS (GCO) SHALL BE PROVIDED WITH 12"x12"x4" THK CONCRETE COLLAR. GCO SPACING SHALL NOT BE MORE THAN 50'-0" APART.
11. ALL EXISTING VENT-THRU-ROOF'S (VTR) TO REMAIN UNLESS NOTED OTHERWISE, NEW WASTELINE CONNECT EXISTING WASTELINE FOR VTR.
12. CONTRACTOR TO TEST ALL PIPING PRIOR TO COVERING.
13. ALL SLABS, WALLS AND WALL FOOTINGS TO BE DEMO DUE EXISTING WAISTLINE REPLACEMENT SHALL BE REPAIR & RESTORE TO ORIGINAL CONDITION. DO NOT CUT EXIST. BARS. NEW CONCRETE 3000psi min.
14. SEWER WASTE LINES SHOWN WERE BASED ON AVAILABLE DOCUMENTS PROVIDED BY GHURA AND ARE APPROXIMATE LOCATIONS ONLY. PRIOR TO THE START OF CONSTRUCTION THE CONTRACTOR SHALL FIELD VERIFY ACTUAL LOCATIONS AND SHALL IMMEDIATELY NOTIFY GHURA OF ANY DISCREPANCIES BETWEEN THE PLANS FOR THIS PROJECT AND ACTUAL FIELD CONDITIONS WHICH MAY INTERFERE WITH THIS PROJECT.
15. THE CONTRACTOR SHALL MAKE CONNECTIONS TO EXISTING SEWER LATERAL IN ALL APPROVED MANNER AND DO SO WITH MINIMUM INTERRUPTION OF SERVICE.

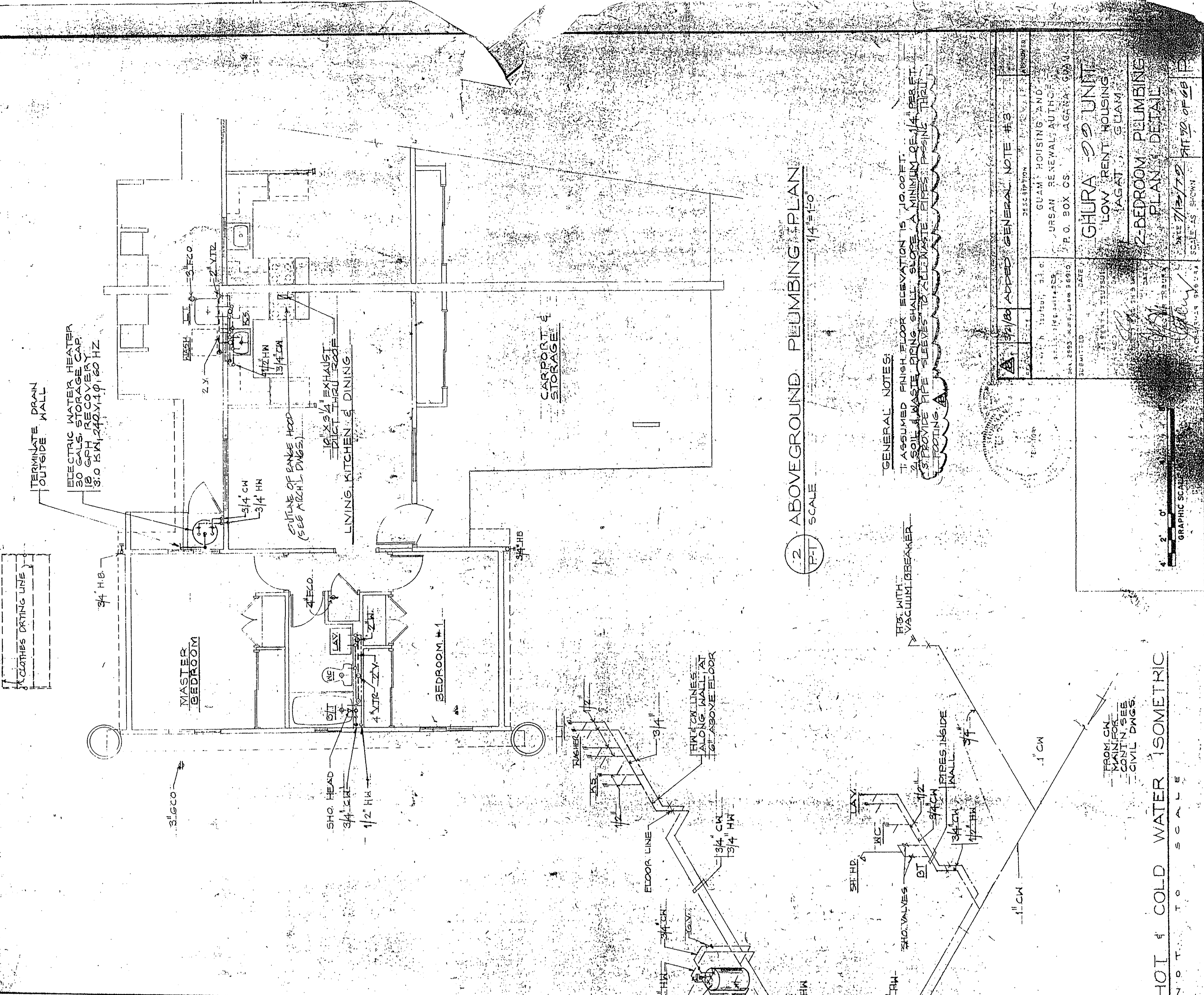

2 ABOVEGROUND PLUMBING PLAN  
 P-1 SCALE 1/4" = 1'-0"

GENERAL NOTES:  
 1. ASSUMED FINISH FLOOR ELEVATION IS 10.00 FT.  
 2. SOIL & WASTE PIPING SHALL SLOPE A MINIMUM OF 1/4" PER FT.  
 3. PROVIDE PIPE SLEEVES TO ALL WASTE PIPES PENETRATING THROUGH FLOORING.

NO.	DESCRIPTION	DATE
1	ISSUED FOR PERMITS	7/12/79
2	ISSUED FOR PERMITS	7/12/79
3	ISSUED FOR PERMITS	7/12/79

SUBMITTED DATE: 7/12/79  
 DRAWN BY: [Signature]  
 CHECKED BY: [Signature]  
 SCALE: AS SHOWN  
 SHEET NO. OF 28

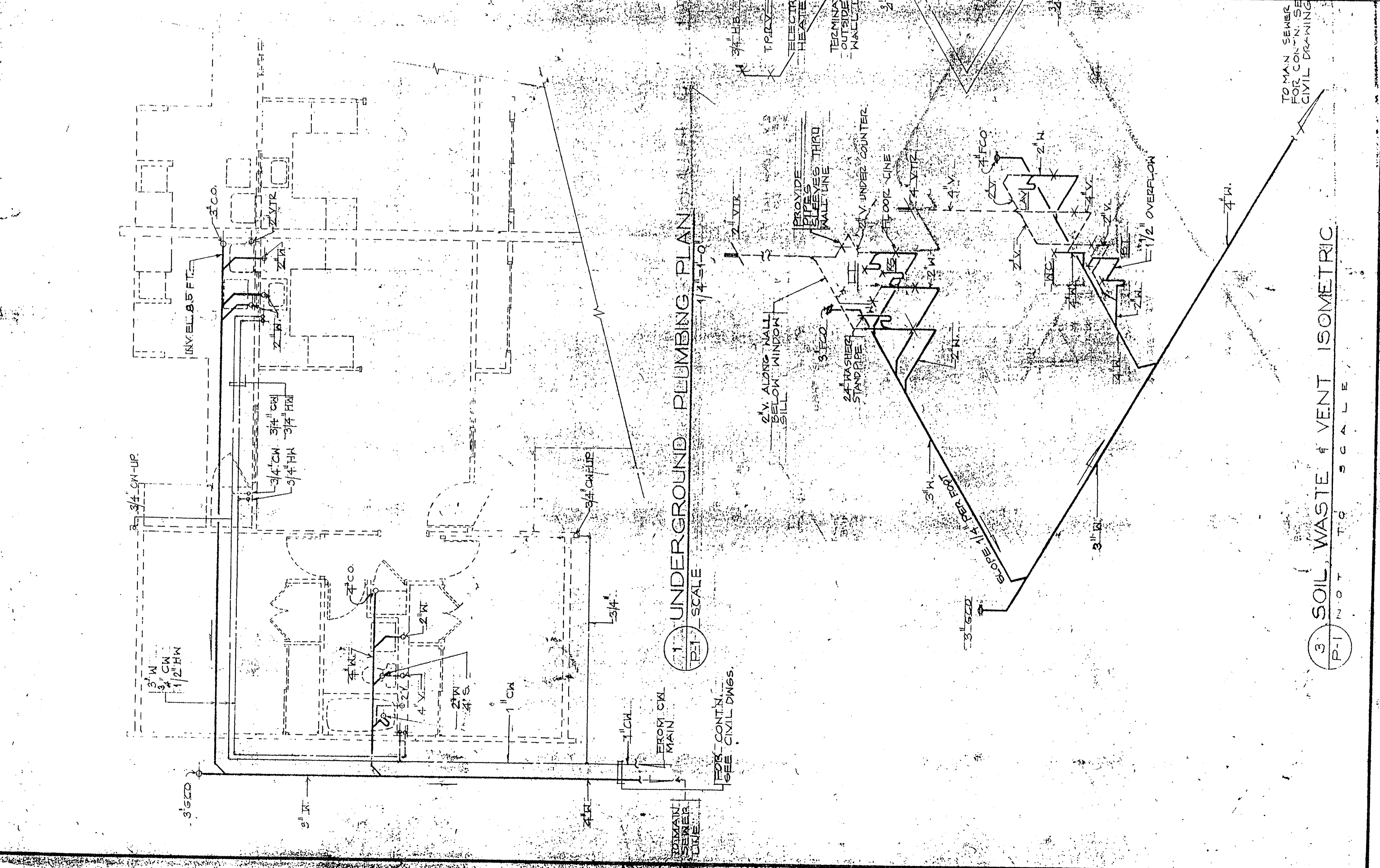

1 UNDERGROUND PLUMBING PLAN  
 P-1 SCALE 1/4" = 1'-0"

3 SOIL, WASTE & VENT ISOMETRIC  
 P-1 NOT TO SCALE

HOT & COLD WATER ISOMETRIC  
 NOT TO SCALE

TO MAIN SEWER FOR CONTIN. SEE CIVIL DRAWING

FROM CIVIL DRAWING FOR CONTIN. SEE CIVIL DWGS.

## SCOPE OF WORK

### 134 S. DOYLE, GHURA 83MERIZO (3-bedroom)

#### GENERAL NOTES

- Existing interior and exterior waste line to be completely removed up to front C/O and disposed. Provide new PVC waste line system. Existing vents to remain and reconnected to new system. New waste line replacement shall consist of approved assigned drawings by Registered Engineer and contractor to submit all documents required prior to start of work. Waste line replacement will include patch and touch-up paint at waste line entry points on walls. Other existing items damaged incidental with construction activities shall be repaired by the contractor at no additional cost to GHURA.
- See SPECIAL CONDITIONS for front entrance, rear entrance, storage, and WH closet EXTERIOR DOOR replacements. WH closet or closet door to be vented. Note additional work at FRONT entrance. Storage door to be single centered 36" door with ½" cement board on metal frame in-fill.
- Remove and replace all vinyl tiles. New tiles to be vinyl composition 1/8" thick, submit sample to GHURA for review and approval. Caulk any gaps at wall base. Apply 2 coats (min.) of wax on vinyl tiles. Ensure tiles are entirely cleaned (free of dirt, dust, grease) prior to placement of 2 coats wax.

#### 1. LIVING ROOM

Fixed window at left of FRONT entrance door to be removed. Infill area with 8" CMU. Plaster and paint to match surrounding wall from top of slab to mid height. Infill remaining area with reinforced glass block.

#### 2. KITCHEN

- Existing sink base cabinet to be demolished and disposed. Provide new base cabinet; base cabinet lay-out shall match existing in-kind.  
New Base Cabinet shall consist with:
  - Concrete floor base 3" thick reinforced (#3@8"O.C. each way centered)
  - Cabinet frames (vertical & horizontal) shall be 2"x2"x 11ga (.120") Steel Square Tube, all joints shall be full weld primer painted (gray color).
  - Counter top shall be 3 layers of ½" thick cement board with Thin-set mortar bonding between each board, ¼" stainless steel countersunk screw fastened at

12" maximum on center. Ceramic tile 12" min. and bull-nose at all edges.  
Submit sample for approval.

- Cabinet side end walls shall be 2 layers of ½" thick cement board with Thin-set mortar between layers and ¼" stainless steel countersunk screw fastened at 12" maximum on center.
- Shelves, cabinet drawers and doors shall be ¾" thick termite treated wood.
- Replace Kitchen sink with new accessories to include lever-type faucet, ½" supply lines and ½' x ½" angle valves.
- Wall hung cabinets over sink to be replaced with existing in-kind composed entirely of ¾" termite treated wood.
- Remove and replace ceramic tiles at opposite counters to match sink counter (except bull-nose on edge)
- Submit drawings and samples for approval.

Remove shelf straddling kitchen to LR wall and smooth top.

### 3. BATHROOM

Remove ceramic floor tiles and homemade concrete berm at doorway.. Chip floor for slope to shower drain and replace ceramic tiles. Submit samples for approval.

### 4. EXTERIOR

Install main shut-off valve (ball type) 1 – 2 ft. after water meter with appropriate encasement,  
Demolish utility countertop to edge of sink and fabricate 4" CMU support. Remove and dispose of cast iron sink, replace with free standing fiberglass utility sink anchored to deck and walls.

### 5. SEE SPECIAL CONDITION

## PLUMBING NOTES (NEW WORK)

NOTES:

1. Contractor shall field verify existing condition & dimensions prior to bidding. Contractor to notify contracting officer for any discrepancies between scope of work, actual field conditions and project intent which may interfere with this project.
2. Miscellaneous items of work not indicated but which are necessary to implement the project intent of which are customarily performed shall be provided by the Contract Bidder as if fully and correctly described in the scope of work and/or drawings.
3. ALL PLUMBING WORKS SHALL CONFORM TO THE UNIFORM PLUMBING CODE LATEST EDITION, THE CONTRACT DOCUMENTS AND REGULATIONS OF THE GOVERNMENT OF GUAM.
4. NO PIPING SYSTEM SHALL BE BURIED OR CONCEALED UNTIL INSPECTED, TESTED AND ACCEPTED BY GHURA. ALL PIPING SHALL BE TESTED FOR LEAKAGE.
5. ALL EXISTING WAISTLINE TO BE REMOVE AND DISPOSED SHALL BE IN ACCORDANCE W/ GUAM ENVIRONMENTAL PROTECTION AGENCY (GEPA).
6. ALL HORIZONTAL VENT LOOP SHALL BE SLOPED SO AS TO ALLOW MOISTURE TO DRAIN BACK TO WASTE PIPE.
7. ALL WASTE LINES OR PIPING SHALL HAVE A SLOPE OF 1/4" PER FOOT. PIPE TRENCHES SUB-BASE GRADE SHALL BE 90% COMPACTED TO AVOID PIPE MISSALIGNMENT.
8. NEW WASTE LAYOUT BENDS SHALL CONSISTED WITH LONG RADIUS BENDS (UNLESS NOTED OTHERWISE), EXTERIOR WASTE LINES SHALL BE 36" MIN. AWAY FROM BUILDING WALL FOOTINGS.
9. PROVIDE PIPE SLEEVES FOR PIPES PASSING THRU WALLS AND FOUNDATIONS.
10. ALL GROUND CLEANOUTS (GCO) SHALL BE PROVIDED WITH 12"x12"x4" THK CONCRETE COLLAR. GCO SPACING SHALL NOT BE MORE THAN 50'-0" APART.
11. ALL EXISTING VENT-THRU-ROOF'S (VTR) TO REMAIN UNLESS NOTED OTHERWISE, NEW WASTELINE CONNECT EXISTING WASTELINE FOR VTR.
12. CONTRACTOR TO TEST ALL PIPING PRIOR TO COVERING.
13. ALL SLABS, WALLS AND WALL FOOTINGS TO BE DEMO DUE EXISTING WAISTLINE REPLACEMENT SHALL BE REPAIR & RESTORE TO ORIGINAL CONDITION. DO NOT CUT EXIST. BARS. NEW CONCRETE 3000psi min.
14. SEWER WASTE LINES SHOWN WERE BASED ON AVAILABLE DOCUMENTS PROVIDED BY GHURA AND ARE APPROXIMATE LOCATIONS ONLY. PRIOR TO THE START OF CONSTRUCTION THE CONTRACTOR SHALL FIELD VERIFY ACTUAL LOCATIONS AND SHALL IMMEDIATELY NOTIFY GHURA OF ANY DISCREPANCIES BETWEEN THE PLANS FOR THIS PROJECT AND ACTUAL FIELD CONDITIONS WHICH MAY INTERFERE WITH THIS PROJECT.
15. THE CONTRACTOR SHALL MAKE CONNECTIONS TO EXISTING SEWER LATERAL IN ALL APPROVED MANNER AND DO SO WITH MINIMUM INTERRUPTION OF SERVICE.

# GHURA 83

# AMP 3

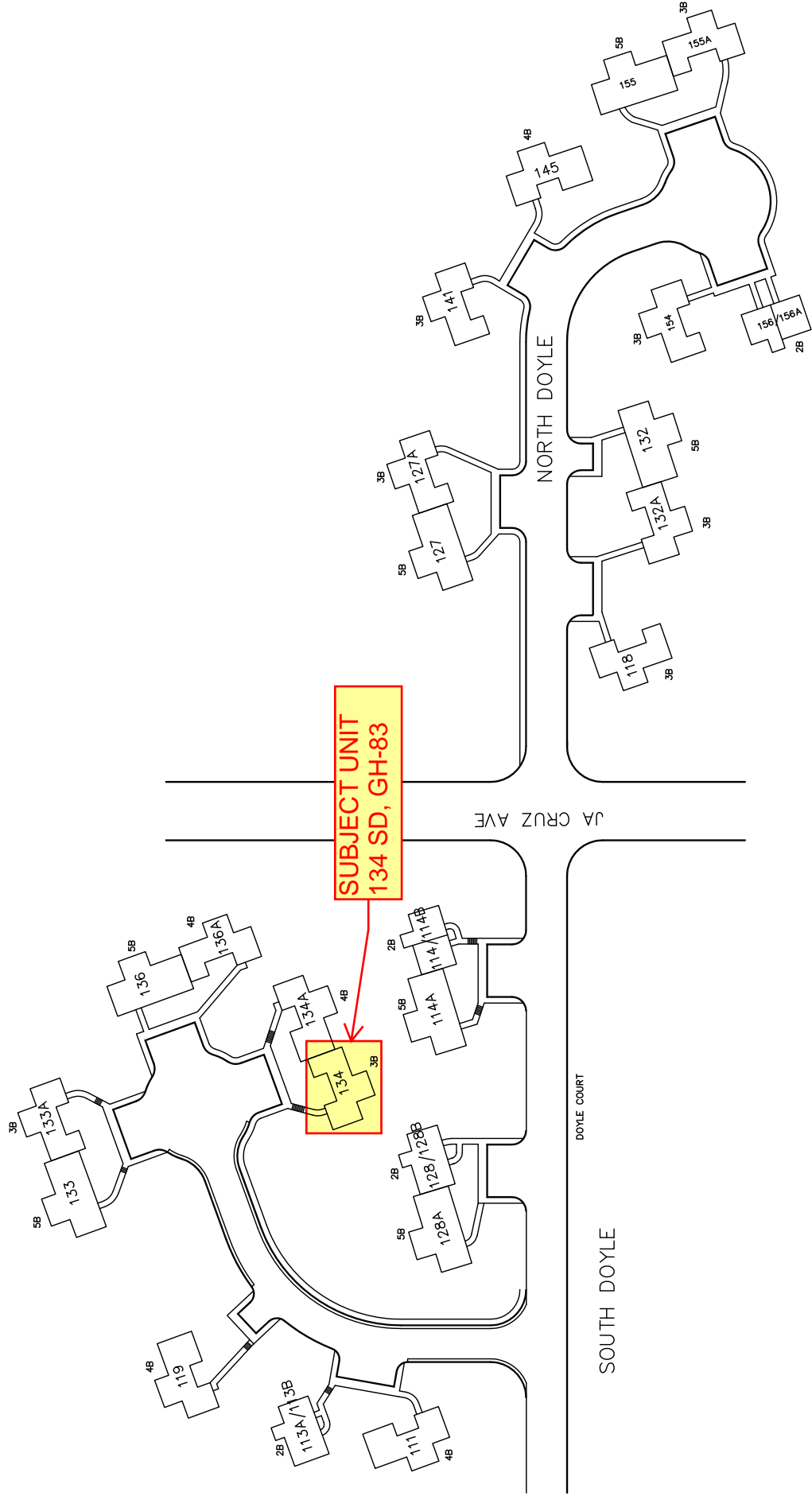

**GHURA 83 - MERIZO SITE PLAN**  
 SCALE: \_\_\_\_\_  
 NTS



GHURA 83

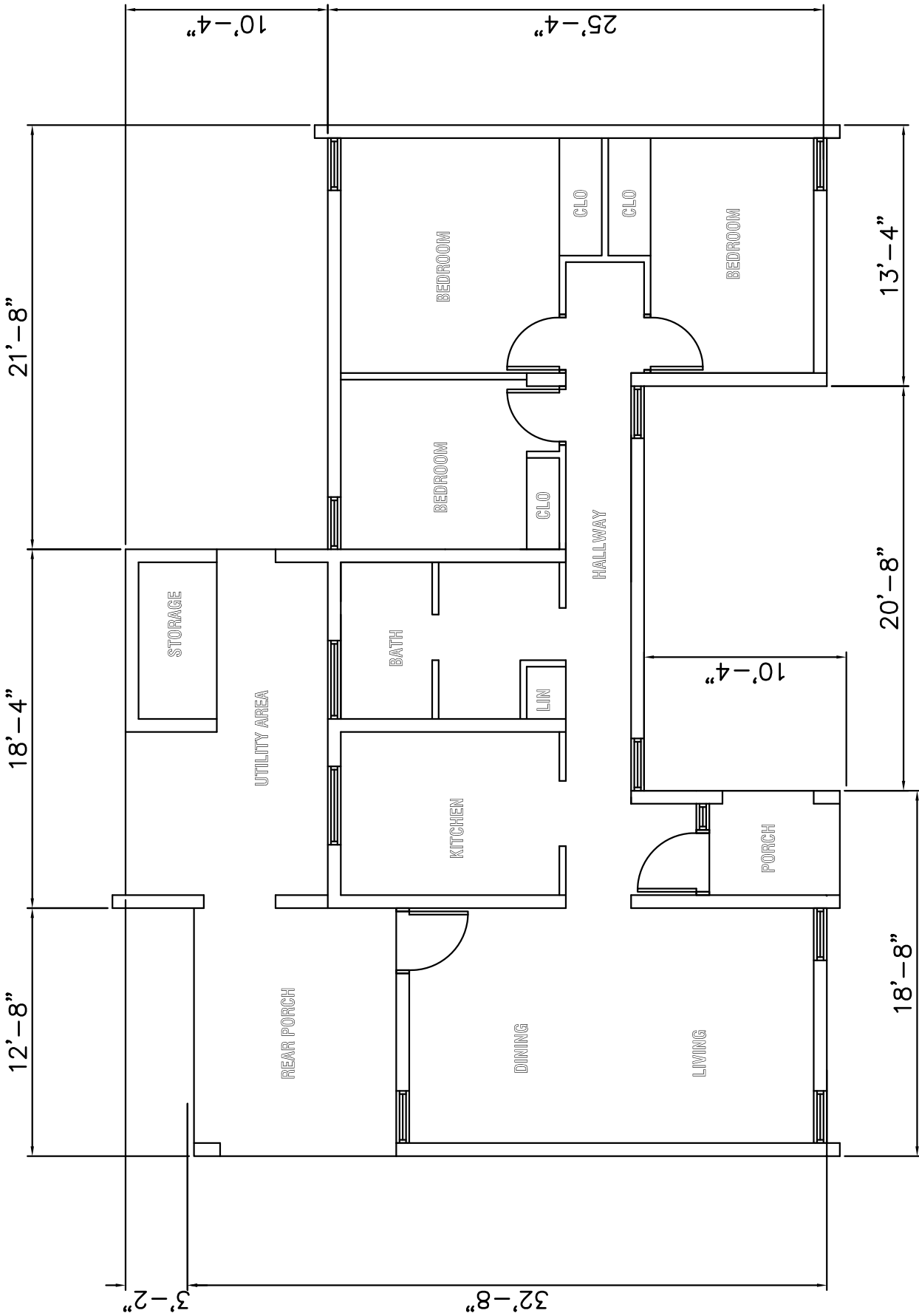

**3BEDROOM FLOOR PLAN**

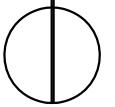

SCALE 1/8" = 1'-0"

GUAM HOUSE  
 URBAN RENEWAL  
 BOX CS

SOUTHERN REN  
 SHEET T  
 (MERI  
 PLAN and

ACCEPTED BY  
 CHAIRMAN

SCALE AS SHOWN DATE 15 May 20

BASIC 2

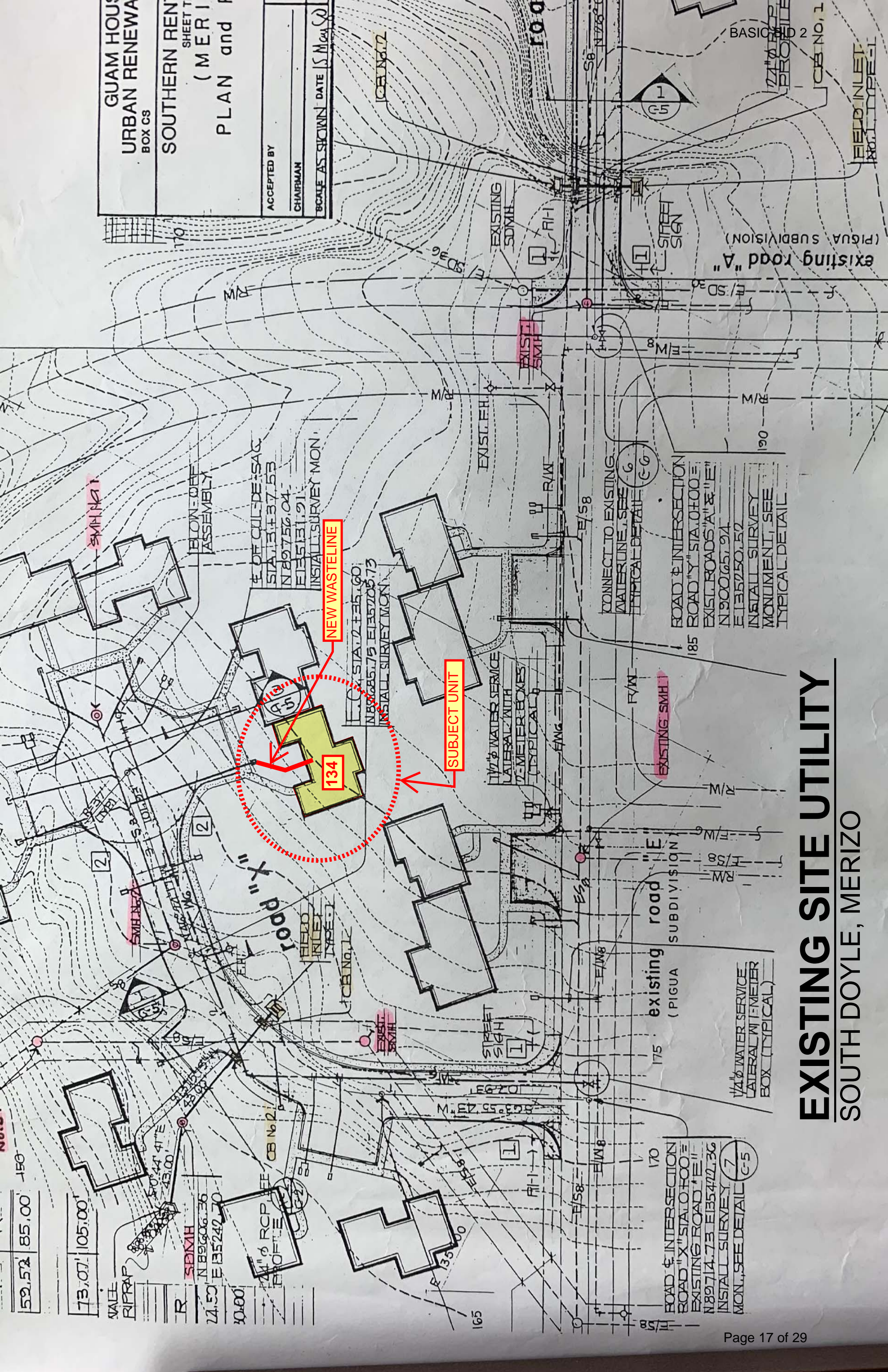

52.52' 85.00' 150'

73.07' 105.00'

1/4" RCP PIPE  
 24.50' N 89°06'36" E  
 24.50' E 135°24'30" E

30.00'

1/4" RCP PIPE  
 24.50' N 89°06'36" E  
 24.50' E 135°24'30" E

NEW WASTELINE

SUBJECT UNIT

134

175 existing road "E"  
 (PIGUA SUBDIVISION)

170  
 ROAD & INTERSECTION  
 ROAD "X" STA. 0+00 =  
 EXISTING ROAD "E"  
 N 89°14'73" E 135°42'36"  
 INSTALL SURVEY  
 MON., SEE DETAIL C-5

CONNECT TO EXISTING  
 WATERLINE, SEE  
 TYPICAL DETAIL C-6

185 ROAD & INTERSECTION  
 ROAD "Y" STA. 0+00 =  
 EXIST. ROADS "A" & "E"  
 N 90°06'51" E  
 E 135°50'52"  
 INSTALL SURVEY  
 MONUMENT, SEE  
 TYPICAL DETAIL

1/4" WATER SERVICE  
 LATERAL WITH  
 1/2" MEETER  
 BOX (TYPICAL)

existing road "A"  
 (PIGUA SUBDIVISION)

# EXISTING SITE UTILITY

## SOUTH DOYLE, MERIZO

## **184A JQQ GHURA 83 UMATAC 3-bedroom**

### **Scope of Work:**

- Complete WATER LINE (HW & CW) replacement. Abandon existing water line and provide New 1/2inch copper water line.
- Electrical Panel board Box: Remove existing electrical panel board exterior of building. Provide new panel board interior of building opposite side of existing, new panel board to accommodate existing and additional loads required, see attached approved electrical design drawing. Prior to start of work Contractor shall field verify existing condition and notify GHURA for any discrepancies between Existing condition and design drawings.

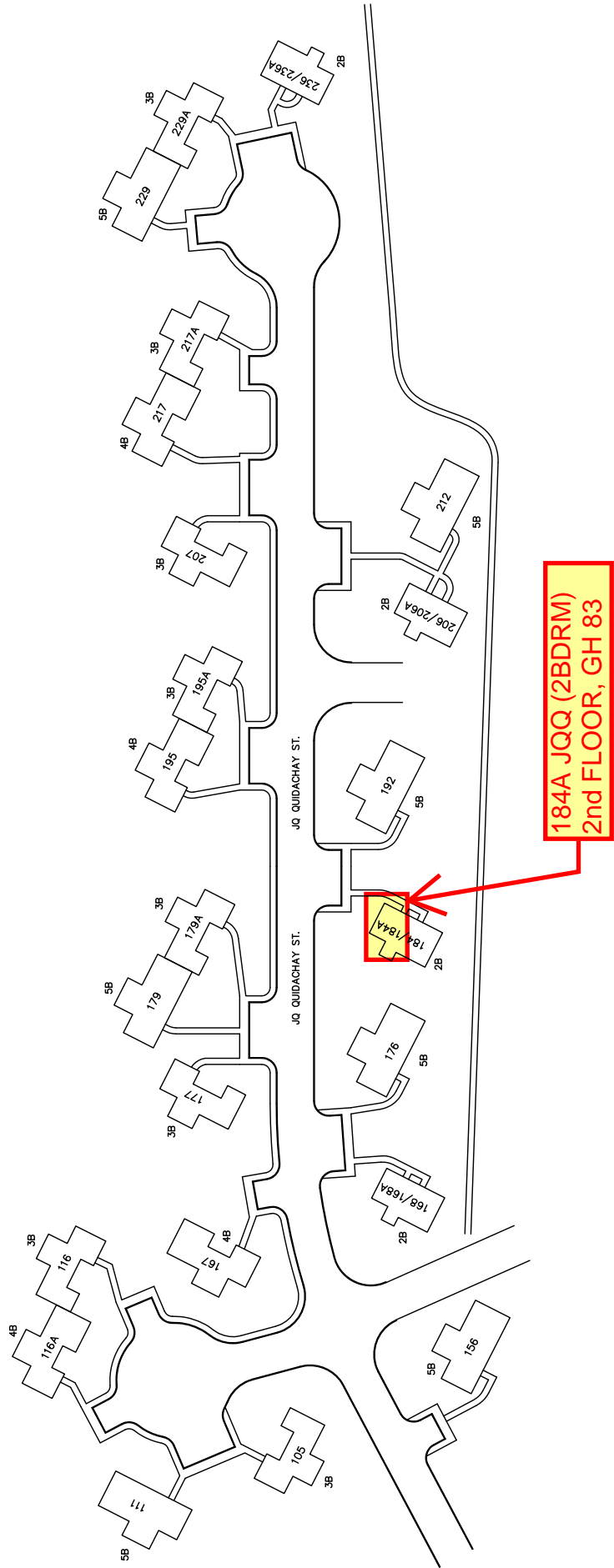

**GHURA 83 - UMATAC SITE PLAN**

NTS

SCALE:

42'-8"

GHURA 83

6'-4"

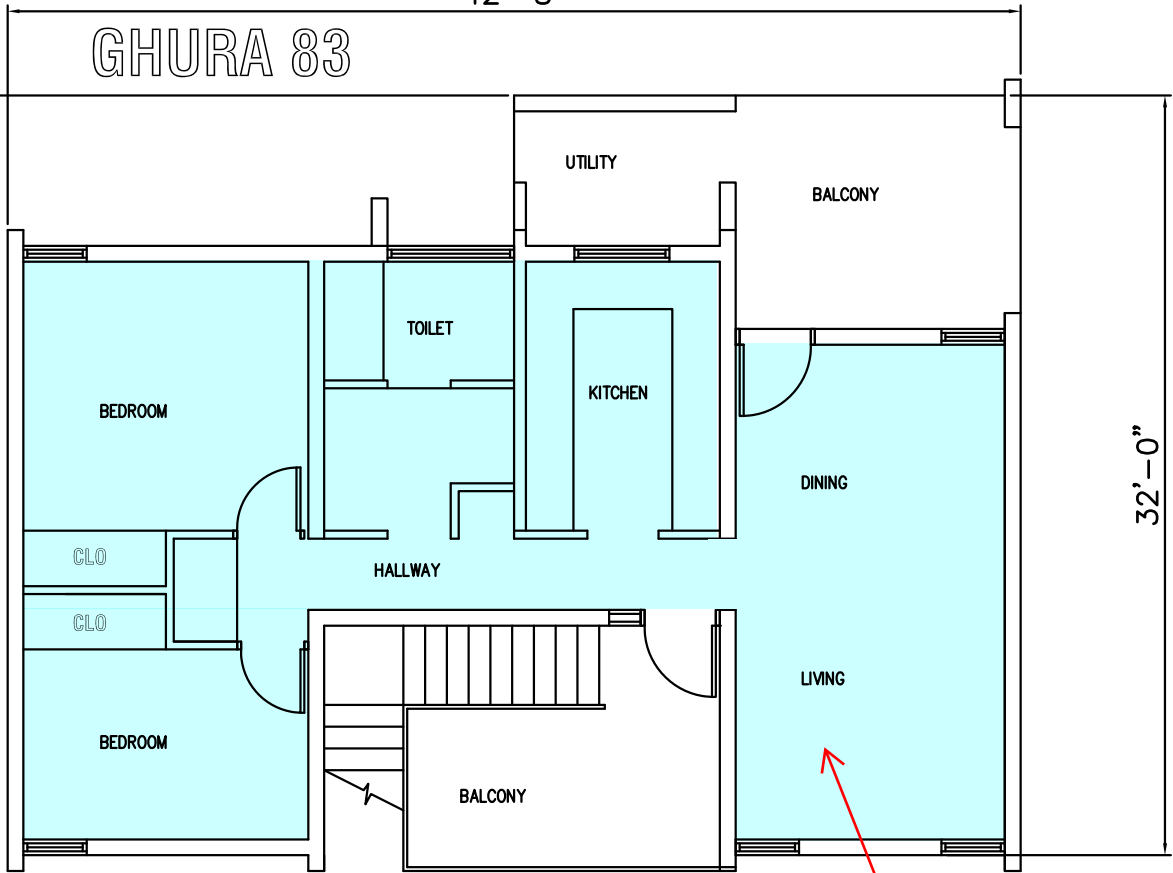

21'-4"

21'-4"

184A @ 2nd FLOOR

32'-0"

6'-4"

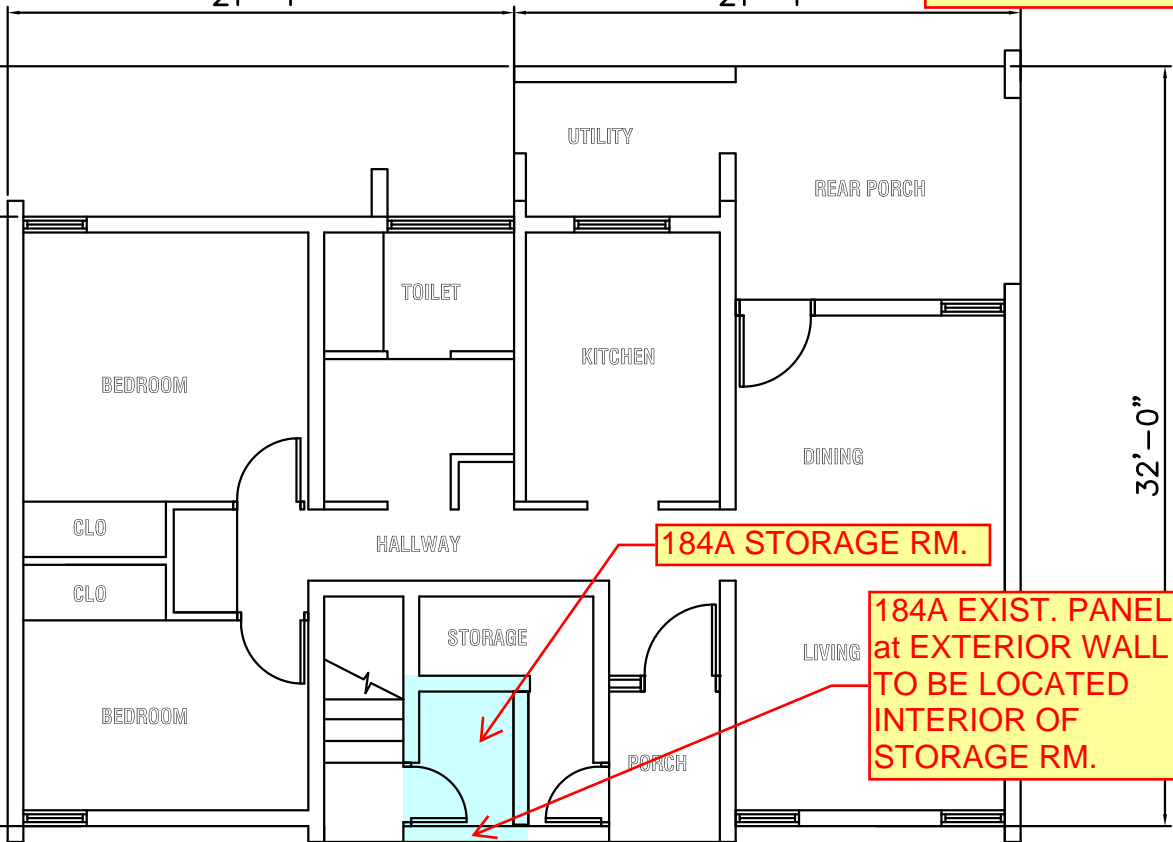

25'-8"

184A STORAGE RM.

184A EXIST. PANEL at EXTERIOR WALL TO BE LOCATED INTERIOR OF STORAGE RM.

32'-0"

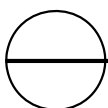

# 2-BEDROOM DUPLEX (2 STOREY)

SCALE 1/8" = 1'-0"

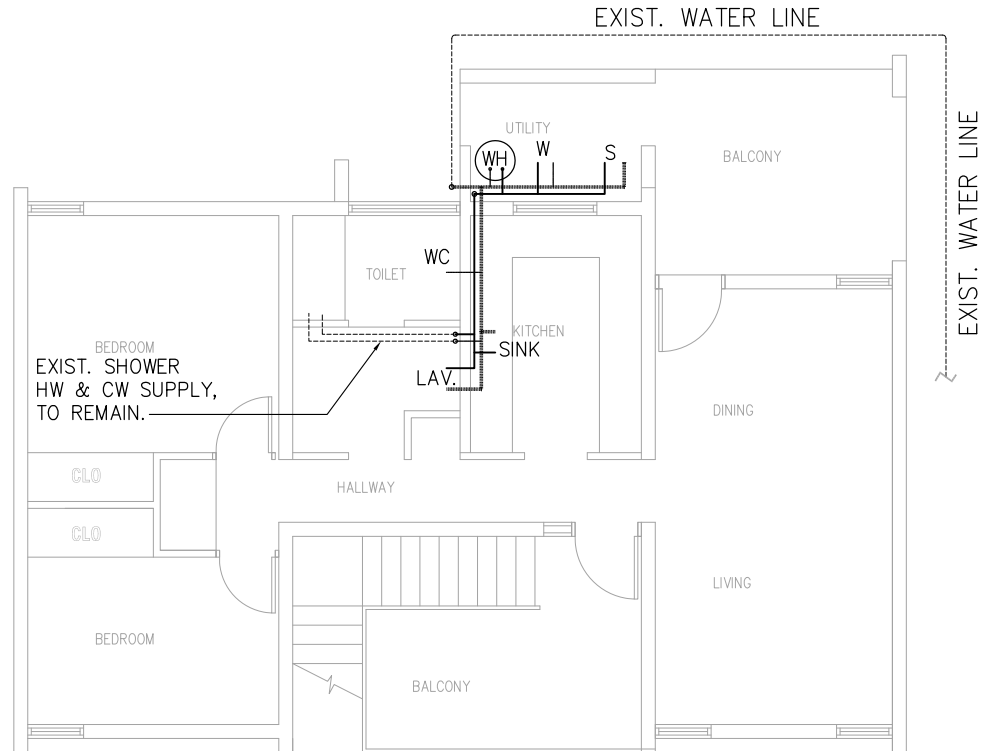

NOTE (CONTINUATION):

7. THE CONTRACTOR SHALL MAKE CONNECTIONS TO EXISTING PIPE FOR VENT THRU ROOF (VTR). REMOVE & DISPOSE EXIST. WASTELINE PIPES EFFECTED WITH WORK LIMIT, PROVIDE END CAP OF EXIST. WASTE LINE TO REMAIN. DEEP TO TO PIPE. CONTRACTOR TO FIELD VERIFY EXIST. WASTE LINE PIPE ELEVATION (POINT OF CONNECTION) TO INSURE ADEQUATE SLOPE FOR NEW WASTE LINE.
8. WASTE LINE TRENCH COMPACT SUB BASE 90% COMPACTION PRIOR TO NEW WASTE LINE PLACEMENT AND SAND BEDDING.
9. ALL SLABS, WALLS AND WALL FOOTINGS TO BE DEMO DUE EXISTING WASTELINE REPLACEMENT SHALL BE REPAIR & RESTORE TO ORIGINAL CONDITION. DO NOT CUT EXIST. BARS. NEW CONCRETE 3000psi min.
10. WORK SHALL INCLUDE FLOOR CERAMIC TILE DEMO & NEW WORK, TO INCLUDE WALL TILES & PAINTING WHERE WORK OCCURS.
11. PROVIDE NEW ANGLE VALVES, SUPPLY HOSES. CLAMPS & FASTENERS. METAL FRAME DROP CEILING (FRAME 16"O.C. EACHWAY W/ 1/4THK. CEMENT BOARD, PROVIDE INSULATION AROUND ALL WASTE LINE PIPES).
12. Contractor shall field verify all existing waterline, plumbing fixtures and hose bibs to ensure operable and working condition. All fixtures and hose bibs shall free from leaks or other defects. Provide new fixtures and hose bibs where existing fixtures and hose bibs found defective or missing.
13. Miscellaneous items of work not indicated but which are necessary to implement the project intent of which are customarily performed shall be provided by the Contract Bidder as if fully and correctly described in the scope of work and/or drawings. Contractor to notify GHURA official prior to commencement of work.

## 184A, JQQ (2nd LEVEL)

### 2-BEDROOM DUPLEX (2 STOREY)

SCALE 1/8" = 1'-0"

### NEW WATER LINE LAYOUT

# 184A, JQQ 2nd LEVEL

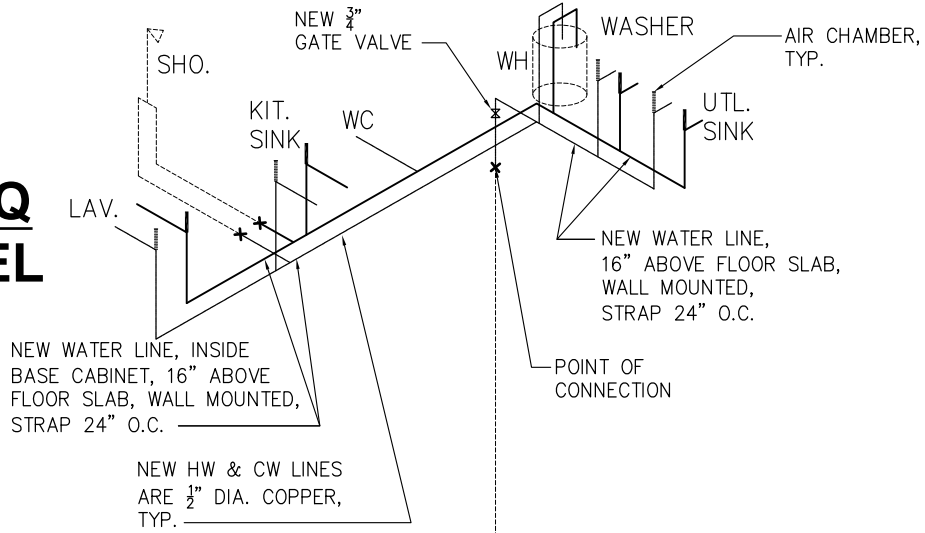



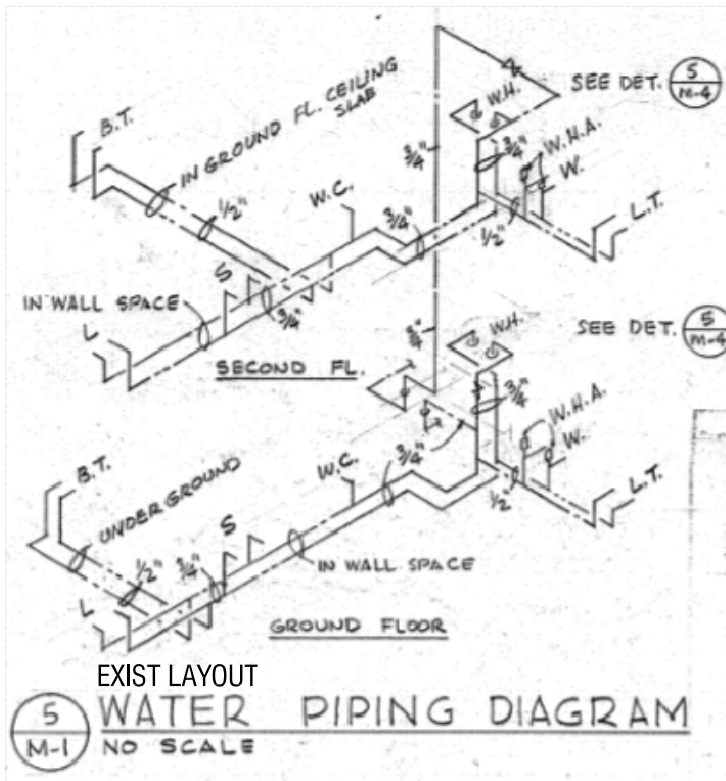
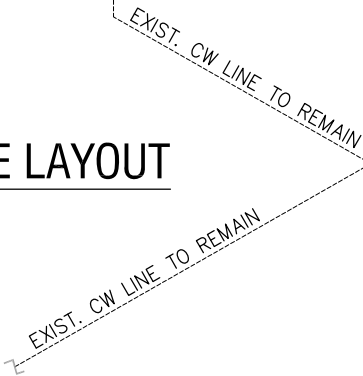



## ISOMETRIC - NEW WATER LINE LAYOUT 2ND FLOOR







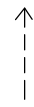

129B EXIST. WATER LINE TO BE ABANDONED INSIDE EXIST. WALL

# REMOVAL AND MODIFICATION NOTES

-  EXISTING RECEPTACLE TO BE PROVIDED WITH WEATHERPROOF COVER. NEW CIRCUIT BREAKERS SHALL BE GFC1 TYPE.
-  INSTALL NEW DRYER OUTLET COMPLETE WITH WIRING.
-  INSTALL AIR CONDITIONER OUTLET COMPLETE WITH WIRING AT LIVING ROOM AREA.
-  EXISTING EXTERIOR PANEL & ENCLOSURE TO BE REMOVED & PROVIDE NEW PANEL OPPOSITE THE EXISTING.
-  EXISTING EXTERIOR PANEL TO BE REPLACED WITH NEW ALL EXISTING BRANCH CIRCUITS TO BE CONNECTED TO NEW PANEL.
-  EXISTING EXTERIOR PANEL TO BE REPLACED WITH NEW AND INSTALL OPPOSITE INSIDE . FOR MODIFICATIONS OF WIRING.
-  EXISTING TELEPHONE & CABLE TV CABINET TO BE PROVIDED WITH NEW COVER ONLY.

# REMOVAL AND MODIFICATION NOTES

-  SINGLE RECEPTACLE, WALL, SURFACE MOUNTED, 2P30A, 250V
-  EXPOSED CONDUIT, HOME RUN TO NEW PANEL
-  ELECTRIC PANELBOX, WALL, FLUSH MOUNTED
-  EXISTING TELEPHONE CABINET, WALL, FLUSH MOUNTED
-  EXISTING TELEPHONE CABINET, WALL, FLUSH MOUNTED
-  EXISTING KILOWATT HOUR METER
-  REMOVAL MODIFICATION NOTE INDICATOR
-  EXISTING DUPLEX RECEPTACLE WITH NEW WEATHER PROOF COVER

# ELECTRICAL GENERAL NOTES:

1. ALL ELECTRICAL WORK SHALL BE IN ACCORDANCE WITH THE APPLICABLE SECTIONS OF THE NATIONAL ELECTRICAL CODE (NEC) 2002 & RULES AND REGULATIONS OF PUBLIC WORKS AND GOVERNMENT OF GUAM.
2. ALL ELECTRICAL MATERIALS SHALL BE UL LISTED WHERE LISTING IS AVAILABLE FOR THAT TYPE OF EQUIPMENT OR TO ANSI OR NEMA STANDARDS.
3. WORKMANSHIP SHALL CONFORM TO CONSTRUCTION PRACTICES RECOMMENDED BY AMERICAN ELECTRICIAN HANDBOOK (LATEST EDITION) AND SHALL BE SUBJECT TO THE APPROVAL OF THE AGENCY WHO HAS JURISDICTION AND THE ENGINEER.
4. ALL METALLIC ENCLOSURES OF NEW (ONLY) INSTALLATION, RACEWAY AND ELECTRICAL EQUIPMENT SHALL BE GROUNDED IN ACCORDANCE WITH THE REQUIREMENTS OF NEC ARTICLE 250. PROVIDE GROUND WIRE IN EVERY RACEWAY. SIZE IN ACCORDANCE WITH NEC TABLE 250-95.
5. CONDUIT SHALL BE EMT & ALUMINUM WHERE PERMITTED BY NEC.
6. MINIMUM SIZE OF WIRE SHALL BE NO.12 AWG AND MINIMUM SIZE OF CONDUIT SHALL BE 1/2" DIAMETER.
7. ALL ELECTRICAL WORK SHALL BE UNDER THE FULL SUPERVISION OF A MASTER ELECTRICIAN LICENSED TO PRACTICE ON GUAM.
8. ALL ELECTRICAL EQUIPMENT EXPOSED TO WEATHER SHALL BE WEATHERPROOF.
9. AFFECTED ADJACENT AREAS AFFECTED BY WORK SHALL BE RESTORED TO ORIGINAL CONDITION AT NO ADDITIONAL COST TO THE GOVERNMENT.
10. ALL NEW ELECTRIC PANELBOARD SHALL BE PROVIDED WITH TYPE WRITTEN CIRCUIT DIRECTORY.
11. ALL CIRCUITS INSIDE BEDROOMS SHALL BE ARC FAULT CIRCUIT BREAKER TYPE.
12. VERIFY EXISTING CONDITIONS. PROVIDE ALL LABOR AND MATERIALS NECESSARY TO COMPLETE INTENT OF THE PROJECT, READY FOR USE.



PANEL <u>"THREE BEDROOM"</u>		<u>120/240</u> VOLTS <u>1</u> PHASE <u>3</u> WSN BREAKER MIN. AIC <u>10,000</u> FLUSH MOUNTING <u>125A</u> MAIN CB						
CKT. NO.	USE	CIRCUIT BREAKER		CONNECTED LOAD ( KVA )			WIRE	
		POLE	AMPS	A	B	C		
1	LIGHTS-KITCHEN/DINING/PATIO (EXISTING LOAD)	1	20	0.5			#12	
2	LIGHTS AND RECEP-BEDROOM (EXISTING LOAD) **		20	1.6				
3	LIGHTS-BATH/HALLWAY/BEDROOM/HALL (EXISTING LOAD)		20		1.3			
4	LIGHTS AND RECEP-LIVING ROOM (EXISTING LOAD)		20		1.0			
5	RECEP-DINING (EXISTING LOAD)		20	1.5				
6	RECEP-KITCHEN (EXISTING LOAD) *		20	1.0				
7	RECEP-KITCHEN (EXISTING LOAD)		20		1.5			
8	RECEP-BATH/PATIO (EXISTING LOAD) *		20		1.0			
9	HEATERS-CLOSETS (EXISTING LOAD) **		20	1.0				
10	WASHING MACHINE-LAUNDRY (EXISTING LOAD)		20	1.5				
11	REFRIGERATOR (EXISTING LOAD)	↓	20		1.2		↓	
12	ELECTRIC WATER HEATER (EXISTING LOAD)	2	30		2.25		#10	
13	SPARE	1	20	1.0			-	
14	PART OF CIRCUIT NO.12	-	-	2.25			#10	
15	DRYER-LAUNDRY (NEW LOAD)	2	30		2.5		#10	
16	WINDOW A/C LOAD-LAUNDRY (NEW LOAD)	2	30		1.0		#10	
17	PART OF CIRCUIT NO.15	-	-	2.5			#10	
18	PART OF CIRCUIT NO.16	-	-	1.0			#10	
19	RANGE	2	50		6.0		#6	
20	SPARE	1	20		1.0		-	
21	PART OF CIRCUIT NO.19	1	20	6.0			#6	
22	PFB	1	20	1.0			-	
23	PFB	1	20		1.0		-	
24	PFB	1	20		1.0		-	
* USE GFCI CIRCUIT BREAKER ** USE ARC FAULT CIRCUIT BREAKER				CONNECTED/ PHASE		20.85	20.75	I= 80.7 AMPS
				TOTAL LOAD		41.6 KVA		
				DEMAND FACTOR		.47		
				DEMAND LOAD		19.36 KVA		

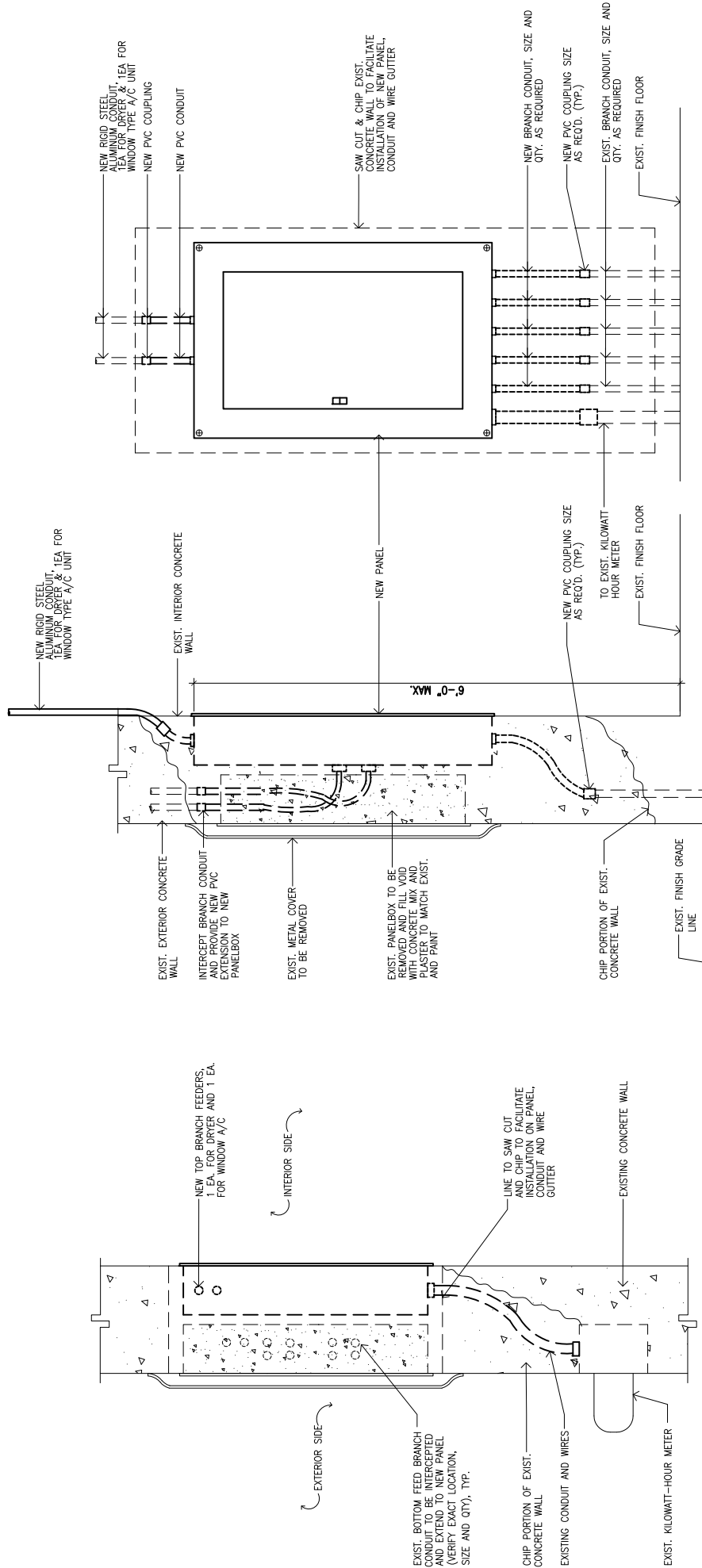

FRONT VIEW  
SCALE: NTS

SIDE VIEW  
SCALE: NTS

PLAN  
SCALE: NTS

PANELBOARD INSTALLATION  
SCALE: NTS

**A20, UPPER AGAT (1-bedroom)**

## GENERAL NOTES

- Existing interior doors to be completely removed and replaced solid core doors, sizes to match existing in-kind. New solid core doors shall consist with 3-each 4" hinges per door and all knobs shall be lever type. Provide new paint finish.
- Replace existing waterlines (HW & CW) within the pipe chase walls, and kitchen sink area. New work shall consist with angle valves & supply hoses.
- See SPECIAL CONDITIONS for front entrance, rear entrance, storage, and WH closet EXTERIOR DOOR replacements. WH closet or closet door to be vented. Note additional work at FRONT entrance. Storage door to be single centered 36" door with ½" cement board on metal frame in-fill.
- Remove and replace all vinyl tiles. New tiles to be vinyl composition 1/8" thick, submit sample to GHURA for review and approval. Caulk any gaps at wall base. Apply 2 coats (min.) of wax on vinyl tiles. Ensure tiles are entirely cleaned (free of dirt, dust, grease) prior to placement of 2 coats wax.
- \* Provide 1/4"thk cement board overlay at exist. gypsum wall to remain

## 1. KITCHEN

- Existing Base (2each) and Upper cabinets to be demolished and disposed. Provide new Upper cabinet, new layout to match existing in-kind, termite all woods. New Base Cabinets (2each) shall consist with:
  - Concrete floor base 3" thick reinforced (#3@8"O.C. each way centered)
  - Cabinet frames (vertical & horizontal) shall be 2"x2"x 11ga (.120") Steel Square Tube, all joints shall be full weld primer painted (gray color).
  - Counter top shall be 3 layers of ½" thick cement board with Thin-set mortar bonding between each board, ¼" stainless steel countersunk screw fastened at 12" maximum on center. Ceramic tile 12" min. and bull-nose at all edges. Submit sample for approval.
  - Cabinet side end walls shall be 2 layers of ½" thick cement board with Thin-set mortar between layers and ¼" stainless steel countersunk screw fastened at 12" maximum on center.
  - Shelves, cabinet drawers and doors shall be ¾" thick termite treated wood.
  - Replace Kitchen sink with new accessories to include lever-type faucet, ½" supply lines and ½' x ½" angle valves.
  - Wall hung cabinets over sink to be replaced with existing in-kind composed entirely of ¾" termite treated wood.
  - Remove and replace ceramic tiles at opposite counters to match sink counter (except bull-nose on edge)
- \* Provide 1/4"thk cement board overlay at exist. gypsum wall to remain

- Submit drawings and samples for review and approval.
2. BATHROOM GHURA INSPECTION REQUIRED NEW WATERLINE & PIPE CHASE WALL
- Existing pipe chase between bathroom and kitchen to be completely demo and disposed. Replace all water line (HW & CW) entirety. Provide new reinforced concrete curb 8inches high. Provide new pipe chase with metal frames and provide 1/2in. thick cement board both sides, new ceramic tiles finish layout to match existing in-kind. Provide new water closet & lavatory with lever type faucet, shower valve & assembly, and other plumbing accessories.
  - \* Provide 1/4"thk cement board overlay at exist. gypsum wall to remain
3. EXTERIOR
- Install main shut-off valve (ball type) 1 – 2 ft. after water meter with appropriate encasement,
  - Replace all Exterior doors (main & rear doors, storage & water heater doors), all doors with Aluminum jambs, main doors to include security screen doors with lockset. Locksets to be universally keyed (one key fits all).
4. SEE SPECIAL CONDITION

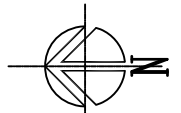
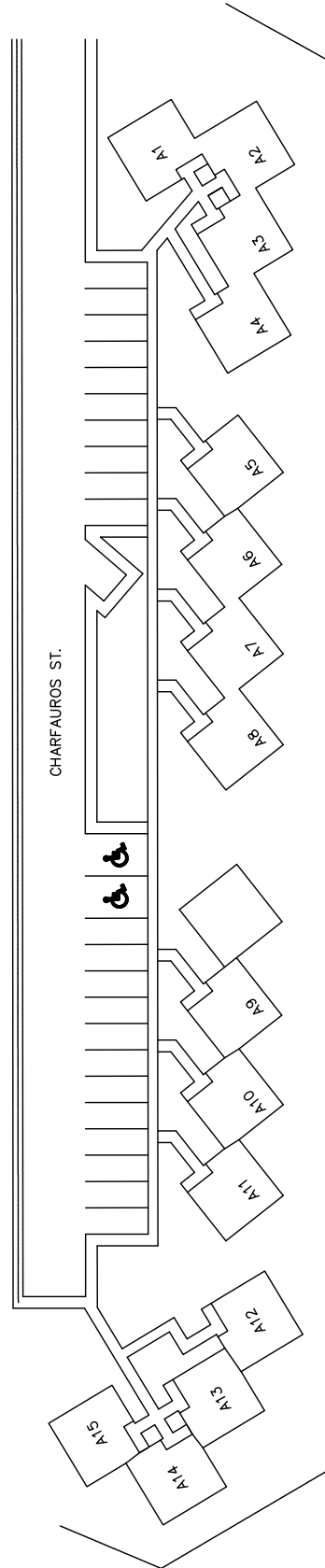
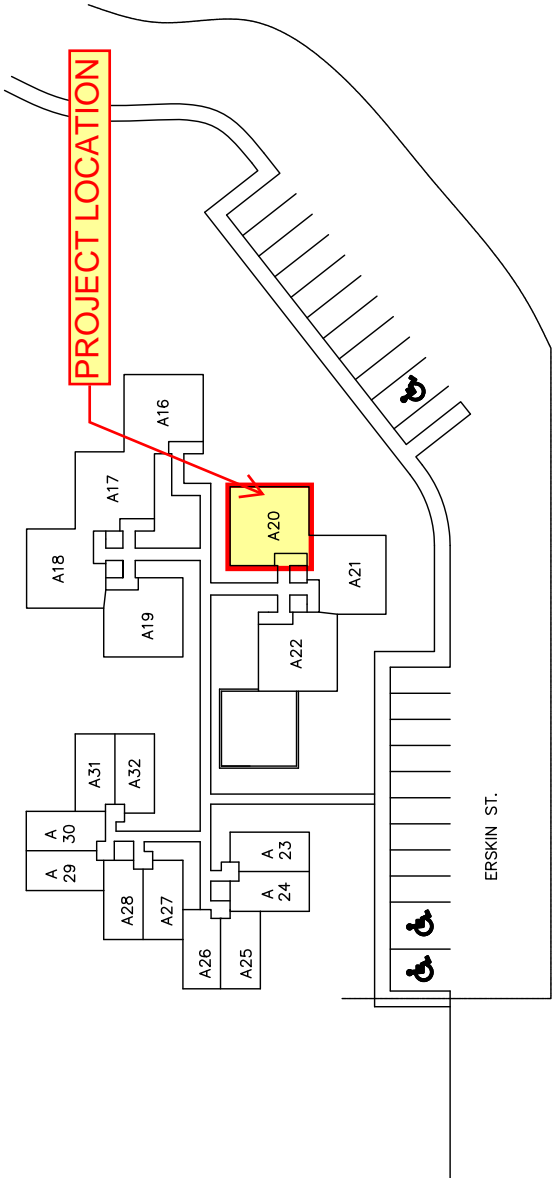

GHURA 82 - AGAT SITE PLAN

NTS

SCALE:

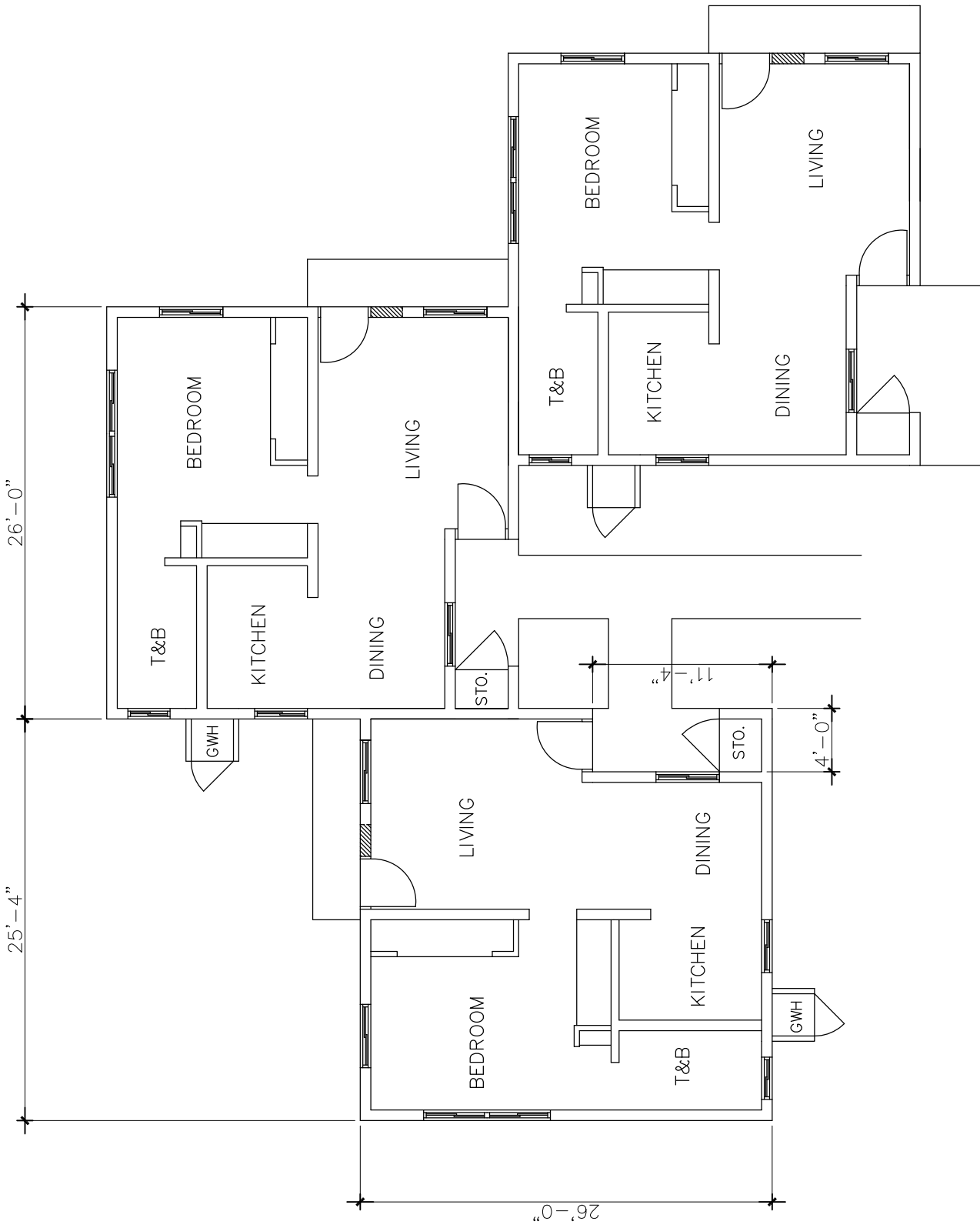

ONE BEDROOM (TYPE-1) TRIPLEX

# SPECIFICATIONS

## TABLE OF CONTENTS

Document Document	Project Title Page Table of Contents
DIVISION 1 - GENERAL REQUIREMENTS	
Section 01010	Summary of Work
Section 01012	Supplementary Conditions
Section 01068	References
Section 01150	Schedules, Reports, Payments
Section 01205	Procedures and Controls
Section 01310	Project Management and Coordination
Section 01330	Submittal Procedures
Section 01440	Requests for Information
Section 01450	Quality Control
Section 01500	Temporary Facilities and Control
Section 01560	Environmental Protection
Section 01567	Maintenance of Traffic
Section 01600	Product Requirements
Section 01700	Execution Requirements
Section 01705	Project Closeout
Section 01780	Closeout Submittals
DIVISION 2 - SITEWORK	
Section 02050	Demolition and Removal
Section 02102	Clearing and Grubbing
Section 02201	Earthwork for Utilities
Section 02203	Base Course
Section 02280	Soil Treatment
Section 02713	Exterior Water Distribution System
Section 02722	Exterior Sanitary Sewer System
Section 02831	Chain Link Fences
DIVISION 3 - CONCRETE	
Section 03100	Concrete Forms and Accessories
Section 03200	Concrete Reinforcement
Section 03300	Cast-In-Place Concrete
Section 03301	Miscellaneous Concrete Structures
Section 03350	Concrete Finishes
DIVISION 4 - MASONRY	

TABLE OF CONTENTS	T-1
-------------------	-----

Section 04200	Unit Masonry	
DIVISION 5 - METALS		
Section 05500	Metal Fabrications	
Section 05520	Steel Handrails and Guards	
Section 05720	Aluminum Handrails and Guards	
DIVISION 6 - WOOD AND PLASTICS		
Section 06100	Rough Carpentry	
Section 06200	Finish Carpentry	
Section 06400	Architectural Woodwork	
Section 06650	Solid Polymer Fabrications	
DIVISION 7 - THERMAL AND MOISTURE PROTECTION		
Section 07110	Waterproofing	
Section 07120	Fluid-Applied Urethane Roofing	
Section 07190	Water Repellents (Sealer)	
Section 07210	Building Insulation	
Section 07620	Sheet Metal Flashing and Trim	
Section 07840	Firestopping	
Section 07900	Joint Sealers	
DIVISION 8 - DOORS AND WINDOWS		
Section 08100	Hollow Metal Doors and Frames	
Section 08210	Wood Doors	
Section 08310	Access Doors and Panels	
Section 08400	Entrances, Storefronts, Doors and Windows	
Section 08560	Storm Protection	
Section 08710	Door Hardware	
Section 08800	Glass and Glazing	
DIVISION 9 - FINISHES		
Section 09200	Lath and Plaster	
Section 09300	Tile	
Section 09650	Resilient Flooring	
Section 09900	Painting	
DIVISION 10 - SPECIALTIES		
Section 10200	Louvers and Vents	
Section 10810	Toilet Accessories	
DIVISION 11 - Not Used		
DIVISION 12 - Not Used		
DIVISION 13 - Not Used		
DIVISION 14 - Not Used		
DIVISION 15 - MECHANICAL		
Section 15400	Interior Plumbing System	
DIVISION 16 - ELECTRICAL		
Section 16050	Basic Electrical Materials and Methods	

TABLE OF CONTENTS

T-3



SECTION 01010  
SUMMARY OF WORK

PART 1 GENERAL

1.1 SUMMARY

- A. Section Includes:
1. Work covered by the Contract Documents.
  2. Contractor's use of the premises.
  3. Occupancy requirements.
- B. Related Documents:
1. The Contract Documents, as defined within this Section, apply to the work. Additional requirements and information necessary to complete the work may be found in other Documents.
  2. Owner's Bid and Contract documents per 01012.

1.2 WORK COVERED BY CONTRACT DOCUMENTS

- A. Provide and pay for all labor, materials, services, equipment, permits, fees, licenses, taxes, and other items necessary for the execution, installation and completion of all work indicated in the Contract Documents.
- B. The work involves the construction of Work includes, but is not limited to, demolition, earthwork, site utilities, site improvements, paving, and landscaping. Work also includes concrete foundations, slabs-on-grade, concrete, cast-in-place concrete roof membrane, metal fabrications, thermal and sound insulation, concrete masonry unit walls, non-structural metal framing, carpentry, gypsum board walls and ceilings, ceramic tile, resilient flooring, carpeting, acoustical ceilings, aluminum storefronts and windows, glazing, hollow metal doors and frames, wood doors, door hardware, cabinetry and fixtures, toilet partitions and accessories, painting, typhoon shutters, fire detection system, electrical, plumbing, complete and ready for use.
- C. Coordination: The work of this Contract includes coordination of the entire work of the Project, from the beginning of activity through project close-out and the warranty periods.
- D. Drawings: Preparation of "As-Built" Drawings showing the location of all new work.
- E. The work and appurtenances shall be all in strict accordance with the Contract Documents, except only those items specifically shown, noted, or specified as not in the Contract (NIC), or OFCI, or those materials designated as OFCI.
- F. Summary of References: Work of the Contract can be summarized by reference to the Contract, General Conditions, Supplementary Conditions, Special Provisions, Labor Standards Provisions, Specifications Sections as listed in the Table of Contents bound herewith, Drawings, Addenda and Modifications to the Contract Documents issued subsequent to the initial printing of these Specifications, and including, but not necessarily limited, to printed matter referenced by any of the above.

SUMMARY OF WORK 01010-1

1.3 CONTRACTOR'S USE OF PREMISES

- A. During construction, the Contractor shall have full use of the Project Site and to the immediate area for construction operations. Contractor shall minimize disruption to the public and to activities in and around adjacent roads, streets, buildings and other facilities.
- B. The Contractor must limit use of the premises to construction activities only in the areas indicated:
1. Confine operations to areas within the Contract limits indicated. Portions of the Site beyond the areas in which construction operations are permitted are not to be disturbed or used.
  2. Keep driveways and entrances serving the public and adjacent buildings and properties clear and useable at all times. Do not use these areas for parking or storage of materials unless approved, in writing, by the Owner's representative.
  3. Schedule deliveries to minimize time and space required for storage of materials and equipment on the Project Site.
  4. Provide temporary fencing, barricades, signage, traffic control and personnel necessary for public safety.

PART 2 PRODUCTS

Not Used.

PART 3 EXECUTION

Not Used.

END OF SECTION

SUMMARY OF WORK

01010-2

SECTION 01012  
SUPPLEMENTARY CONDITIONS

March	3
April	3
May	4
June	5
July	7
August	8
September	8
October	8
November	7
December	5

PART 1 GENERAL

- 1.1 PROJECT SITE
  - A. The Project Site is located as shown on Drawing.
- 1.2 CONTRACT DOCUMENTS
  - A. Contract form shall be:
    - 1. AIA Standard Form - Owner/Contractor Agreement
    - 2. Owner prepared Agreement
    - 3. Government of Guam Agreement Form
  - B. General Conditions should be:
    - 1. AIA Standard Form - General Conditions A-201
    - 2. Government of Guam General Conditions
  - C. Owner-issued bid and contract documents shall take precedence should there be conflict between the Owner-issued documents and these Specifications.
- 1.3 TIME OF COMPLETION
  - A. The work shall commence upon Contract signing and shall be thereafter substantially completed within the Contract Time. Prerequisites for substantial completion are indicated in Section 01705 - Project Closeout.
- 1.4 LIQUIDATED DAMAGES
  - A. In case of failure on the part of the Contractor to complete the work within the time fixed in the Contract or within any time extensions given thereof, the Contractor and his sureties shall be liable for and shall pay to the Owner for his real damages, the sum of \$\_\_\_\_\_ liquidated damages, per calendar day of delay, until the work is completed and accepted.
- 1.5 CLIMATIC CONDITIONS
  - A. The contract time for this Contract allows for the following number of days lost due to adverse climatic conditions in each month. Time extension on account of inclement weather will be allowed only for lost days of work in excess of the limits shown below. Time extension on account of inclement weather on Saturday and Sunday shall be granted only if the Contractor has confirmed, in writing, his intention to work on those days. Allowance for delays will not be given for interior work and other work which can proceed during periods of inclement weather.
 

Month	Non-Working Days
January	4
February	3

SUPPLEMENTARY CONDITIONS 01012-1

1.6 FEES

- A. The Contractor will be responsible for all processing and payment of fees and payments pursuant to the construction of this Project. Included are Building Permit and regulatory agencies fees. The Contractor will be responsible for submitting the required drawings and other required documents to the respective agencies and following up until permits have been issued.

1.7 DRAWINGS AND SPECIFICATIONS

- A. Upon award of the Construction Contract, the Owner will furnish the Contractor, without charge, four (4) copies of the Drawings and Specifications. Additional copies requested by the Contractor will be furnished at cost.

1.8 ELECTRONIC DOCUMENTS

- A. With concurrence of the Owner, the Architect and Consultants will release to the Contractor project drawings in electronic format. As a condition of release, the Contractor shall sign an Electronic Data Transfer Indemnity Agreement prepared by the Architect, and reimburse the Architect and Consultants for the cost of formatting and transferring the electronic files.

1.9 ADMINISTRATIVE SUBMATERIALS

- A. Contractor will submit for approval within ten (10) calendar days of award of the Contract, the following, which may also be referred to in other portions of these Specifications:

1. Resume of the project superintendent indicating qualifications to provide project supervision.
2. List of all subcontractors to be used on the project.
3. Schedule of Values.
4. Progress Schedule.
5. Performance and Payment Bonds.
6. Insurance Certificates.

1.10 BONDS

- A. The Contractor shall furnish to the Owner, in a form satisfactory to the Owner, at the Owner's request, a Performance Bond and a Labor and Materials Payment Bond, each in the sum of 100% of the Contract Sum, and with a Bond Rider naming the Contractor as principal, corporate surety satisfactory to the Owner, as surety and any construction lender

SUPPLEMENTARY CONDITIONS 01012-2

and lessee (if the Project is leasehold) as additional or dual obligees. The Contractor shall require the attorney-in-fact who executes the required bonds on behalf of the surety to affix thereto a certified and current copy of his Power of Attorney.

1.11 CONTRACTOR'S AND SUBCONTRACTOR'S INSURANCE

- A. The Contractor shall not commence work under this Contract until he has obtained all insurance required hereunder, and such insurance has been submitted to the Owner. The Contractor shall not allow any subcontractor to commence work under his subcontract until all similar insurance required of the subcontractor has been obtained. Approval of the insurance by the Owner shall not relieve or decrease the liability of the Contractor hereunder.
- B. Workman's Compensation and Employer's Liability Insurance: The Contractor shall take out and maintain during the life of this Contract the statutory Workman's Compensation and Employer's Liability Insurance for all of his employees to be engaged in work on the Project under this Contract, and in case any such work is sublet, the Contractor shall require the subcontractor, similarly, to provide Workman's compensation and Employer's Liability Insurance for all of the subcontractor's employees to be engaged in the work.
- C. Bodily Injury Liability and Property Damage Liability Insurance: The Contractor shall take out and maintain during the life of this Contract such Bodily Injury Liability and Property Damage Liability Insurance as shall protect from claims for damages from personal injury, including accidental death, as well as from operations under this Contract, whether such operations be by himself or by any subcontractor or by anyone directly or indirectly employed by either of them, and the amount of such insurance shall not be less than:
  - 1. Bodily Injury Liability Insurance in an amount not less than One Hundred Thousand Dollars (\$100,000) per person for injuries including wrongful death, and in an amount not less than Three Hundred Thousand Dollars (\$300,000) for injuries including wrongful death resulting from one accident.
  - 2. Property Damage Insurance in an amount not less than Fifty Thousand Dollars (\$50,000) for damages resulting from any one accident, and in an amount not less than One Hundred Thousand Dollars (\$100,000) for damages resulting from all accidents.
- D. Owner's Protective Liability Insurance: The Contractor shall take out, furnish to the Owner and maintain during the life of this Contract, complete Owner's protective liability insurance in the amounts specified above for bodily injury liability insurance and for property damage liability insurance.
- E. Fire, Typhoon, Theft and Vandalism Insurance: The Contractor shall insure the building and other work included in this Contract against loss or damage by fire, typhoon, theft and vandalism, and against loss or damage covered by the standard extended coverage insurance endorsement, with an insurance company or companies acceptable to the Owner, the amount of the insurance at all times to be at least equal to the amount paid on account of work and materials plus the value of work and materials furnished or delivered but not yet paid for by the Owner. The policies shall be in the names of the Owner and the Contractor.
- F. Supplemental to Contractor's and Subcontractor's Insurance:
  - 1. Flood Hazard Insurance: For projects located on the shoreline or in a flood hazard zone, the Contractor, during the life of this Contract, shall secure and maintain Flood Hazard Insurance in the amount equivalent to 100 percent (100%) of the Contract amount, for all damages. The policies shall be in the names of the Owner

SUPPLEMENTARY CONDITIONS

01012-3

and the Contractor.

- G. A certificate of the insurance company as to the amount and type of coverage, terms of policies, etc., shall be delivered to the Owner before commencing work.

1.12 PROGRESS PAYMENTS

- A. Applications for progress payments shall be made monthly on AIA Document G702 and G703 - "Application and Certification for Payment". Retainage of ten percent (10%) of the completed work and stored materials will be withheld until final completion of the work. After the work is 50% complete and should the work be proceeding acceptable to the Owner, the contractor may request the owner to allow the retainage to continue at five percent (5%) of the total contract value.

1.13 AMERICANS WITH DISABILITIES ACT ACCESSIBILITY GUIDELINES (ADAAG)

- A. All persons and entities providing work for this Project are required to be knowledgeable of the requirements of the Americans with Disabilities Act Accessibility Guidelines (ADAAG) as they affect their portion of the work. Do not install work which is not in compliance with ADAAG. Prior to fabrication or installation of any work not in compliance with ADAAG, the Contractor shall notify the Architect and secure design directions to resolve the non-complying features.

1.14 WARRANTY

- A. All work shall be guaranteed, in writing, by the Contractor against defects resulting from the use of defective and inferior materials, equipment, and workmanship for a minimum of one (1) year from the date of substantial completion. Any maintenance service contracts and warranties for equipment in use shall begin the same date of the general warranty against defects described hereinabove.
- B. If, within the warranty period, repairs or changes required in connection with the guaranteed work, which in the opinion of the Owner or Architect are rendered necessary as a result of the use of materials, equipment, or workmanship, which are inferior, defective, or not in accordance with the terms of the Contract, the Contractor shall within five (5) consecutive working days of request by the Owner or Architect, and without expense to the Owner, commence to, in every instance, place in satisfactory condition all such guaranteed work and correct all defects therein, and make good all damages to the building or work or equipment or contents thereof.
- C. Whenever a manufacturer's warranty on any product exceeds one year, that warranty shall become part of the Contract. The Contractor shall complete the warranty forms in the name of the Owner, and submit such forms to the manufacturer within such time as required to validate the warranty. The Contractor shall submit to the Owner a copy of the completed warranty forms for the Owner's record as evidence that such warranty form was filed with the manufacturer.
- D. Any manufacturer's warranty concerning any items installed will run to the benefit of the Owner, and the Contractor agrees to not void or impair or to allow subcontractors to void or impair any original warranty or guaranty existing or running to the benefit of the Owner, as to products or items installed in the Project, provided, however, if the Architect shall designate installation in a method or manner which shall void or impair the aforesaid warranty, the Owner and Architect shall be advised, in advance, in writing, by the Contractor of such violation of the manufacturer's recommended installation and impairment of warranty, and the Architect and Owner may change such installation to conform with the recommended procedures or confirm the method of installation applicable thereto, in writing, to the Contractor.

SUPPLEMENTARY CONDITIONS

01012-4

SECTION 01068  
REFERENCES

1.15 BUILDING AND OCCUPANCY PERMITS

- A. The Contractor shall make application for, process, pay all charges and obtain Building Permit(s) for the Project and provide a copy to the Architect and Owner.
- B. Upon Substantial Completion, the Contractor shall record the Substantial Completion Certificate with the Department of Public Works and deliver an unrestricted Occupancy Permit to the Architect and Owner.

1.16 COMPLIANCE WITH MECHANIC'S LIEN LAW

- A. The Contractor shall comply with provisions of the Government Code of Guam. Contractor shall make such submittals to the Owner, record the required documents, provide releases, publish such notices, post surety bonds, as required, and take other actions within the stipulated time frame, for full compliance with the law.

1.17 DEFAULT

- A. The Owner may declare the Contractor in default in accordance with, and in the manner described in the General Conditions of the Contract for Construction for:
  - 1. Failure to complete the work within the Contract period or any extension thereof.
  - 2. Failure or refusal to comply with an order of the Architect or Owner within a reasonable time.
  - 3. Failure or refusal to remove rejected materials from the Project Site.
  - 4. Failure or refusal to perform anew any defective or unacceptable work.
  - 5. Bankruptcy or insolvency, or the making of an assignment for the benefit of creditors.
  - 6. Failure to pay subcontractors and suppliers promptly.
  - 7. Repeated failure to provide a qualified superintendent, competent workmen or subcontractors to carry out the work in an acceptable manner.
  - 8. Failure to prosecute the work in accordance with the agreed schedule of completion.

END OF SECTION

SUPPLEMENTARY CONDITIONS

01012-5

REFERENCES

01068-1

PART 1 GENERAL

1.1 SUMMARY

A. Section Includes:

- 1. Specifications format and content.
- 2. Quality assurance.
- 3. Reference standards.
- 4. Abbreviations.
- 5. Definitions.

- B. Related Documents: The Contract Documents, as defined in Section 01010 - Summary of Work, apply to the work of this Section. Additional requirements and information necessary to complete the work of this Section may be found in other Documents.

1.2 SPECIFICATIONS FORMAT AND CONTENT

- A. Specifications Format: The Specifications are organized into Divisions and Sections based on the Construction Specifications Institute's (CSI) 16-Division format numbering system.
- B. The Bid and Contract Documents issued by the Owner are included with the Specifications. The Owner-issued documents will take precedence should there be any conflict between them and the Specifications.
- C. Specifications Content: The Specifications use certain conventions in language and intended meaning of certain terms, words and phrases when used in particular situations or circumstances. These conventions are explained as follows:

- 1. Abbreviated Language: Language used in the Specifications and other Contract Documents is abbreviated type. Words and meanings shall be interpreted as appropriate. Words that are implied, but not stated shall be interpolated as the sense required. Singular words will be interpreted as plural and plural words interpreted as singular where applicable and the context of the Contract Documents so indicates.
- 2. Imperative and streamlined language is used generally in the Specifications. Requirements expressed in imperative mood are to be performed by the Contractor. At certain locations in the text, for clarity, subjective language is used to describe the responsibilities that must be fulfilled indirectly by the Contractor or by others when so noted.

- a. The words "shall be" shall be included by inference wherever a colon (:) is used within a sentence or phrase.

1.3 QUALITY ASSURANCE

- A. For products or workmanship specified by association, trade, or other consensus standards, the Contractor shall comply with the requirements of the standard, except when more rigid requirements are specified or are required by applicable codes. Such standards are made a part of the Contract Documents by reference.
- B. Conform to the reference standards by the date of issue that was current on the original date of the Contract Documents.
- C. Obtain copies of the standards when required by the Contract Documents.
- D. Maintain a copy of the standards at the Project Site during submittals, planning and progress of the specific work until Final Acceptance.
- E. Should a specified reference standard conflict with the Contract Documents, request clarification from the Owner's representative before proceeding.
- F. Neither the contractual relationship, duties or responsibilities of the parties to the Contract nor those of the Owner's representative shall be altered from the Contract Documents by any mention or inference otherwise in any reference document.

1.4 INDUSTRY STANDARDS AND CODES:

- A. General Applicability of Standards: Applicable standards of the construction industry and Building Codes adopted by the governing agencies have the same force and effect (and are made a part of the Contract Documents by reference) as if copied directly into the Contract Documents, or as if published copies were bound herewith.
- B. Referenced Standards (referenced directly in the Contract Documents or by governing regulations) have precedence over non-referenced standards which are recognized in the industry for applicability to the work. Except as otherwise indicated, where compliance with an industry standard is required, comply with the standard in effect as of the date of the Contract Documents.
- C. Conflicting Requirements: Where compliance with two or more standards is specified, and the standards establish different or conflicting requirements for minimum quantities or quality levels, refer the requirements that are different but apparently equal, and uncertainties to the Owner's representative for decision before proceeding.
  - 1. Minimum Quantity or Quality Levels: The quantity or quality level shown or specified shall be the minimum provided or performed. The actual installation may comply exactly with the minimum quantity or quality specified or it may exceed the minimum within reasonable limits. In complying with these requirements, the indicated numeric values are minimum or maximum, as appropriate for the context of the requirements. Refer uncertainties to the Owner's representative for a decision before proceeding.
- D. Copies of Standards: Each entity engaged in construction of the Project is required to be familiar with the industry standards applicable to that entity's construction activity. Copies of applicable standards are not bound within the Contract Documents.
  - 1. Where copies of standards are needed for the performance of a required construction activity, the Contractor shall obtain copies directly from the publication source.

1.5 ABBREVIATIONS

REFERENCES

01068-2

- A. Abbreviations and Names: Trade association names and titles of general standards are frequently abbreviated. Where such acronyms or abbreviations are used in the Specifications or other Contract Documents they mean the recognized name of the trade association, standards generating organization, authority having jurisdiction, or other entity applicable to the context of the text provision. Refer to the "Encyclopedia of Associations," published by Gale Research Company.

1.6 DEFINITIONS (People and Entities)

- A. Definitions specified herein are included in order to further clarify terms.
- B. Architect-Engineer (of Record): The Architect-Engineer is the person lawfully licensed to practice in professional disciplines such as architecture or civil, structural, mechanical, and electrical engineering.
- C. Installer: The Contractor or another entity engaged by the Contractor, either as employee, subcontractor or contractor of lower tier, to perform a particular construction activity, including installation, erection, application, unpacking, assembly, placing, finishing, curing, adjusting, cleaning, protection or similar operation. Installers are required to be experienced in the operations they are engaged to perform.
  - 1. Experienced: The term "experienced," when used with the term "installer," means having a minimum number of years experience on projects similar in size and scope to this Project, being familiar with the special requirements indicated, and having complied with requirements of the authorities having jurisdiction.
  - 2. Trades: Using terms such as "carpentry" does not imply that certain construction activities must be performed by accredited or unionized individuals of a corresponding generic name, such as "carpenter." It also does not imply that the requirements specified apply exclusively to tradespersons of the corresponding generic name.
- D. Manufacturer: A person, firm or corporation who makes products.
- E. Owner: The individual, firm, corporation or government entity that owns the Project.
- F. Owner's Representative: The individual, firm or company administering the Contract on behalf of the Owner. Owner's representative may be the Owner him / herself, the Architect of Record, project engineer, Project Manager or other, as designated by the Owner, and includes a duly appointed successor or authorized representative.
- G. Project Field Superintendent: The Contractor's representative at the Project Site who is responsible for continuous field supervision, coordination, quality control, completion of the Project, and for the prevention of accidents, unless another person is designated, in writing, by the Contractor.
- H. Subcontractor: An individual, firm or corporation having a direct contract with the Contractor or with any other subcontractor for performance of a part of the work at the Project Site.
- I. Supplier: A manufacturer, fabricator, supplier, distributor, materialman or vendor having a direct contract with the Contractor or with any subcontractor to furnish materials or equipment to be incorporated into the work by the Contractor or any subcontractor, but does not perform labor at the Project Site.
- J. Separate Contractor: An individual, firm or corporation having a direct contract with the Owner for performance of part of the work at the Project Site.

REFERENCES

01068-3

- K. Testing Laboratory: An independent entity engaged to perform specific inspections or tests, either at the Project Site or elsewhere, and to report on and, if required, to interpret the results of those inspections or tests.
  - L. Trade: See Installer.
  - M. Utility: Local utility agency providing service to the Project.
- 1.7 DEFINITIONS (Things, Services, and Dispositions)
- A. Acceptable: Satisfactory to and approved by the Owner's representative.
  - B. Approve: The term "approved," when used in conjunction with the Owner representative's action on the Contractor's submittals, applications and requests, is limited to the Owner representative's duties and responsibilities as stated in the Contract.
  - C. Change Order: A modification to the Contract.
  - D. Clarification Drawing: A graphic interpretation of a Drawing or other Contract Documents issued by the Architect through the Owner's representative.
  - E. Construction Operations: Activities of the Contractor at the Project Site.
  - F. Directed: Instructed by the Owner's representative.
  - G. Experienced (Qualified): When used to describe the "installer," "fabricator" or similar terms; a person, firm or corporation skilled through observation or of participation in the particular activities required to complete the work or a portion of the work to the degree of quality specified.
  - H. Final Connections: Complete plumbing, mechanical and electrical connections as required and recommended by the manufacturer for optimum operation of the equipment.
  - I. Indicated: The term "indicated" refers to graphic representations, notes or schedules on the Drawings, or other paragraphs or Schedules in the Specifications, and similar requirements in the Contract Documents. Where terms such as "shown," "noted," "scheduled" and "specified" are used, it is to help the reader locate the reference. Location is not limited.
  - J. Install: Operations at the Project Site including actual unloading, unpacking, assembly, erecting, placing, anchoring, applying, working to dimension, finishing, curing, protecting, cleaning and similar operations.
  - 1. Final Connections: Complete plumbing, mechanical and electrical connections as required and recommended by the manufacturer for optimum operation of equipment.
  - K. Mobilization: To establish and commence work activity at the Project Site.
  - L. Partial Occupancy: Partial Occupancy occurs when the Owner begins to occupy part of the Project for its own purposes, such as early fixture set-up, merchandising, etc. Partial Occupancy shall not constitute acceptance of work not in accordance with the Contract Documents.
  - M. Premises: Space or property made available to the Contractor for constructing the work.

REFERENCES 01068-4 CENTRAL POLICE PRECINCT

- N. Project Site: The space available to the Contractor for performing construction operations, either exclusively or in conjunction with others performing other work as part of the Project. The extent of the Project Site is shown on the Drawings and may or may not be identical with the description of the land on which the Project is to be built.
- O. Receive: Accepting a delivery. (Entity responsible for accepting a delivery.)
- P. Regulations: The term "Regulations" includes laws, ordinances, statutes and lawful orders issued by authorities having jurisdiction, as well as rules, conventions and agreements within the construction industry that control performance of the work.
- Q. Reviewed: Examined and found acceptable by the Owner's representative.
- R. Substantial Completion: The stage in progress of the work when the work or a designated portion thereof is sufficiently complete in accordance with the Contract Documents so the Owner can occupy or utilize the work for its intended use.
- S. Substitution: A product that is exchanged for another of the same function and is of equal or better quality.
- T. Supply: To supply, deliver, unload and inspect for damage (same as Furnish).
- U. Unacceptable: Determined not satisfactory by the Owner's representative.

1.8 DRAWING:

- A. Except as otherwise indicated, graphic symbols used on the Drawings are those symbols recognized in the construction industry for the purposes indicated.
- B. Discrepancies: In the event of a discrepancy, as between small scale Drawings and larger scale Details, or between Drawings and Specifications, or within the Specifications, immediately bring the discrepancy to the attention of the Owner's representative / Architect / Engineer for a decision before proceeding with the particular work involved. Work carried out disregarding these instructions is subject to removal and replacement at the Contractor's expense.

PART 2 PRODUCTS

Not Used.

PART 3 EXECUTION

Not Used.

END OF SECTION

01068-5

REFERENCES

SECTION 01150

SCHEDULES, REPORTS, PAYMENTS

PART 1 GENERAL

1.1 SUMMARY

A. Section Includes:

- 1. Coordination
- 2. Progress Schedule
- 3. Submittal Schedule
- 4. Schedule of Values
- 5. Payment Requests

B. Related Documents: The Contract Documents, as defined in Section 01010 - Summary of Work, apply to the work of this Section. Additional requirements and information necessary to complete the work of this Section may be found in other Documents.

1.2 COORDINATION

A. Coordinate both the procedural timing and listing (naming and sequencing) of reports / activities required by the provisions of this Section and other Sections, to afford consistency and logical coordination between submitted reports or lists. Maintain the coordination and correlation between the separate reports by updating on a regular basis. Make the appropriate distribution of each report and updated report to entities involved in the work including the Owner's representative / Architect / Engineer. In particular, provide close coordination of the progress schedule, schedule of values, listing of subcontracts, schedule of submittals, progress reports, and payment requests.

1.3 PROGRESS SCHEDULE

A. The Progress Schedule to comply with requirements set forth in the "General Conditions of the Contract for Construction". Update the Schedule on a regular basis, but no less than every two months.

1.4 SUBMITTAL SCHEDULE

A. General: Immediately following development and acceptance of a fully developed Progress Schedule, prepare a complete schedule of work-related Submittals. Correlate the Submittal Schedule with the listing of principal subcontractors, as required by the General Conditions, and with the "listing of products" or "procurement schedule" as specified in "Products and Substitutions" Section 01605 and elsewhere in the Contract Documents.

B. Form: Show the category of the Submittal, name of the subcontractor, generic description of work covered, related Section number, activity or event number on the Progress Schedule, scheduled date for first submission, and blank columns for the actual date of submittal, re-submittal, and final release or acceptance by the Owner's representative / Architect / Engineer.

SCHEDULES, REPORTS, PAYMENTS 01150-1

1.5 SCHEDULE OF VALUES

A. General: Prepare a Schedule of Values acceptable to the Owner's representative, as required by the General and Supplementary Conditions, in coordination with preparation of the Progress Schedule. Correlate line items with other administrative schedules and forms required for the work, including Progress Schedule, payment request form, listing of subcontractors, schedule of allowances, schedule of alternates, listing of products and principal suppliers and fabricators, and Schedule of Submittals. Provide a breakdown of the Contract Sum in sufficient detail to facilitate continued evaluation of payment requests and progress reports. Break down the principal subcontract amounts into several line items. Round off sums to the nearest whole dollar, but with the total equal to the Contract Sum. Submit three (3) copies of the Schedule of Values to the Owner's representative / Architect / Engineer for review and comment.

B. Unit Cost Allowances: Where required, identify line item values as a product of unit cost x measured quantity, as estimated from best indications in the Contract Documents.

C. Schedule Updating: Update the Schedule of Values when Change Orders affect the listing, and when actual performance of the work involves necessary changes of substance to values previously listed.

1.6 PAYMENT REQUESTS

A. General: Except as otherwise indicated, the sequence of progress payments is to be regular, and each must be consistent with previous applications and payments. It is recognized that certain applications involve extra requirements, including the initial application, application at the time of substantial completion, and the final payment application.

B. Waivers of Lien: For each payment application, waivers of lien from subcontractors who could lawfully and possibly file a lien arising out of the Contract and related to work covered by payment, may be requested. Submit partial waivers for the amount requested (prior to deduction or retainage) on each item; and when the application shows completion of an item, submit final or full waivers. The Owner reserves the right to designate which entities involved in the work must submit waivers.

C. Payment Application Times: The "date" for each progress payment is as indicated in the Owner-Contractor Agreement, or if none, as indicated therein - the 30th day of each month.

D. Application for Payment Form: AIA Document G702 and G703 Continuation Sheets.

E. Application for Payment Preparation: Except as otherwise indicated, complete every entry provided for on the form, including notarization and execution by an authorized person. Incomplete applications will be returned without action. Entries must match the current data of the Schedule of Values and Progress Schedule. Listings must include the amount of Change Orders approved prior to the last day of the "period of construction" covered by the Application.

F. Application Transmittal: Submit four (4) signed copies of each Application for Payment, one copy which is to be completed with waivers of lien and similar attachments. Submit each copy with a transmittal form listing those attachments, and recording the appropriate information related to the Application in a manner acceptable to the Owner's representative / Architect / Engineer.

G. Application Processing: Within ten (10) days of receipt of a properly documented Application, the Owner's representative / Architect / Engineer shall review and certify to the Owner the amount determined to be properly due, or if the form is incorrectly prepared,

SCHEDULES, REPORTS, PAYMENTS 01150-2

return to the Contractor for correction. Upon receipt of a certified Application from the Owner's representative / Architect / Engineer, the Owner will make payment within the time allowed by the Contract Documents.

- H. Initial Payment Application: The principal administrative actions and submittals which must precede or coincide with submittal of the first Application for Payment can be summarized as follows, but not necessarily by way of limitation:
1. Listing of subcontractors, testing laboratory, principal suppliers and fabricators.
  2. Listing of Contractor's staff assignments and principal consultants.
  3. Copies of Building Permit (if Contractor's responsibility) and similar authorizations and permits from governing authorities.
  4. Progress Schedule.
  5. Performance and Labor and Materials Payment Bonds.
  6. Schedule of Values.
  7. Certificates of Insurance.
  8. Submittal Schedule.

I. Application at Time of Substantial Completion: Following issuance of Owner representative's / Architect's / Engineer's final "Certificate of Substantial Completion," and also, in part, as applicable to prior Certificates on portions of completed work as designated, a "special" payment application may be prepared and submitted by the Contractor. The principal administrative actions and submittals which must proceed or coincide with such special applications can be summarized as follows, but not necessarily by way of limitation:

1. Occupancy Permit(s) and similar approvals or certifications by governing authorities and franchised services, assuring the Owner's full access and use of completed work.
2. Final cleaning of the work.
3. Coordination with the Owner on the change over of insurance coverage, including proof of extended coverage, as required.
4. Change of door locks and other Contractor's access provisions to the Owner's property.
5. Listing of the Contractor's incomplete work, recognized as exceptions to the Certificate of Substantial Completion.

J. Final Payment Application: The administrative actions and submittals which must precede or coincide with submittal of a final Application for Payment can be summarized as follows, but not necessarily by way of limitation:

1. Warranties, (Guarantees), maintenance agreements, and similar provisions of the Contract Documents.
2. Test / adjust / balance records, maintenance, instructions, meter readings, start-up performance reports, training, and similar change-over information germane to the

SCHEDULES, REPORTS, PAYMENTS 01150-3

3. Owner's occupancy, use, operation and maintenance of completed work.
4. Turn-over of spare materials, parts and tools to the Owner, as specified herein.
5. Completion of items specified for completion beyond the time of Substantial Completion (regardless of whether or not a special payment application was previously submitted).
6. Release of liens and other assurances, satisfactory to the Owner that unsettled claims will be settled, and that work not actually completed and accepted will be completed without undue delay.
7. Transmittal of required project construction records to the Owner.
8. Proof, satisfactory to the Owner, that taxes, fees and similar obligations of the Contractor have been paid.
9. Satisfactory removal of temporary facilities, services, surplus materials, rubbish and similar elements.
10. Consent of surety for final payment, as required.

PART 2 PRODUCTS

Not Used

PART 3 EXECUTION

Not Used

END OF SECTION

SCHEDULES, REPORTS, PAYMENTS 01150-4



SECTION 01205  
PROCEDURES AND CONTROLS

PART 1 GENERAL

1.1 DESCRIPTION OF WORK

A. The Contractor shall be responsible for the control and coordination of all work by his forces, subcontractors and suppliers. Procedures and performance required for this purpose include:

1. Coordination and meetings including meeting minutes.
2. Pre-Installation Conferences.
3. Adequate administrative and supervisory personnel.
4. Maintenance of surveys and records.
5. Enforcement of tradespeople and workmanship standards.
6. Coordination of the various trades and subcontractors.
7. Conducting of inspections, tests and reports.
8. Coordination of general installation provisions.
9. Proper cutting and patching procedures and techniques.
10. Cleaning and protection of the work.

1.2 COORDINATION AND MEETINGS

- A. General: Prepare and distribute to each entity performing work at the Project Site, a written memorandum of instructions on required coordination of activities, including required notices, reports and attendance at meetings. Prepare similar memoranda for separate contractors where the interfacing of work is required.
- B. Coordination Drawings: Where work by separate entities requires off-site fabrication of products and materials which must be accurately interfaced and closely intermeshed to produce the required results, prepare coordination drawings to interface and sequence the work shown by separate Shop Drawings.

1.3 PRE-INSTALLATION CONFERENCES

- A. General: Schedule and conduct pre-fabrication and pre-installation meetings as required by the Contract Documents. Pre-fabrication and pre-installation meetings are intended to assist the Contractor in determining before hand specific project requirements and to encourage coordination between the various trades. Schedule meetings at times appropriate to the type of work involved. Provide adequate notice to all parties to be involved.

1.4 ADMINISTRATIVE / SUPERVISORY PERSONNEL

A. General: In addition to a general superintendent and other administrative and supervisory personnel required for performance of the work, provide specific coordination personnel as specified herein.

B. Project Coordination: Provide a full-time Project Coordinator, who is experienced in the administration and supervision of building construction, including mechanical and electrical work, and who is hereby authorized to act as the general coordinator of interfaces between units of work. For purpose of this provisions, "Interface" is defined to include the scheduling and sequencing of work, sharing of access to work spaces, installations, protection of each other's work, cutting and preparation of coordination drawings, inspections, tests, and temporary facilities and services.

1.5 SURVEYS AND RECORDS / REPORTS

A. General: Working from lines and levels established by property survey, and as shown in relation to the work, establish and maintain bench marks and other dependable markers to set lines and levels for the work at each story of construction and elsewhere on-site as needed to properly locate each element of the entire project. Advise tradesmen performing the work, of the marked lines and levels provided for their use in the layout of work.

B. Survey Procedures: Verify layout information shown on the Drawings, in relation to the property survey and existing bench marks before proceeding with layout of the actual work. As work proceeds, check every major element for line, level and plumb (where applicable), and maintain an accurate surveyor's log or record book of such checks, available for reference at reasonable times. Record deviations on the Record Drawings.

1.6 TRADESPEOPLE AND WORKMANSHIP STANDARDS

A. General: Investigate and maintain procedures to ensure that persons performing work at the site are skilled and knowledgeable in the methods and craftsmanship needed to produce the required quality levels for workmanship in the completed work. Coordinate the work of trades and subcontractors. Remove and replace work which does not comply with the workmanship standards as specified and as recognized in the construction industry for the applications indicated. Remove and replace work damaged or deteriorated by faulty workmanship and lack of protection of the work.

1.7 INSPECTIONS, TESTS AND REPORTS

A. General: Required inspection and testing services, as called for in the Specifications are intended to assist in the determination of probable compliance of the work with requirements, but do not relieve the Contractor of responsibility for compliance, or for general fulfillment of the requirements of the Contract Documents. The specified inspections and tests are not intended to limit the Contractor's quality control program. Afford reasonable access to agencies and companies performing tests and inspections. Provide adequate notification to the testing service of the schedule which impacts performance of the required tests.

B. Contract Conforming Work:

1. Resulting from Contract and Code Required Testing / Inspection: The Contractor to obtain and pay the cost of Testing / Inspection Services. Contractor to provide for work required to patch any damaged work.
2. Resulting from Owner Required Testing / Inspection: The Owner to pay the cost for initial Testing / Inspection Services. Contractor to patch any damaged work as follows:

PROCEDURES AND CONTROLS

01205-1

PROCEDURES AND CONTROLS

01205-2

PART 3 EXECUTION

3.1 GENERAL INSTALLATION PROVISIONS

- A. Pre-Installation Conferences: Well in advance of the start of installation of every major unit of work which requires coordination and interfacing with other work, meet at the Project Site with installers and representatives of manufacturers and fabricators involved in or affected by the unit of work, and in its coordination or integration with other work which has preceded or will follow. At each meeting review the progress of other work and preparations for the particular work under consideration, including requirements of the Contract Documents, options, related Change Orders, purchases, deliveries, Shop Drawings, product data, quality control samples, possible conflicts, compatibility problems, time schedules, weather limitations, temporary facilities, space and access limitations, structural limitations, governing regulations, safety inspection and testing requirements, required performance results, recording requirements, and protection. Record the significant discussions of each conference, record agreements and disagreements, along with a final plan of action. Distribute records of meetings promptly to everyone concerned, including the Owner's representative / Architect / Engineer.
- B. Installer's inspection of Conditions: Require installer of each major unit of work to inspect substrate to receive work, and conditions under which work will be performed, and to report (in writing to Contractor) unsatisfactory conditions. Do not proceed with the work until unsatisfactory conditions have been corrected in a manner acceptable to Installer.
- C. Manufacturer's Instructions: Where installations include manufactured products, comply with the manufacturer's applicable instructions and recommendations for installation to the extent these are more explicit or more stringent than requirements indicated in the Contract Documents.
- D. Inspect each item of materials and equipment immediately prior to installation, and reject damaged and defective items.
- E. Provide attachment and connection devices and methods for securing work properly as it is installed; true to line and level, and within recognized industry tolerances if not otherwise indicated. Allow for expansions and building movements, provide uniform joint widths in exposed work, organized for the best possible visual effect, as approved by the Architect.
- F. Re-check measurements and dimensions of the work as an integral step for starting each installation.
- G. Install work during conditions of temperature, humidity, exposure, forecasted weather, and status of project completion which will ensure the best possible results for each unit of work, and in coordination with the entire work. Isolate each unit of work from non-comparable work as necessary to prevent deterioration.
- H. Coordinate enclosure (closing-in) of the work with required inspections and tests to minimize the necessity of uncovering work for that purpose.
- I. Mounting Heights: Where mounting heights are not indicated, mount individual units of the work in compliance with ADAAG or industry-recognized standards for the applications indicated. Refer questionable mounting heights to the Owner=s representative / Architect / Engineer for a final decision.

3.2 CUTTING AND PATCHING

- A. General: Do not cut-and-patch structural work in a manner that will result in reduction of

PROCEDURES AND CONTROLS 01205-4

a. Non-conforming Work:

- 1) The Contractor to pay the cost for initial testing / inspection and other fair costs, if any, incurred by the Owner and Architect which directly result from the testing / inspection requirements of non-conforming work.
  - 2) The Contractor to correct defective work to meet the Contract requirements. Pay for all subsequent costs including, but not limited to, further testing, as may be required. Requests for additional time will generally not be considered when resulting from the installation of and/or correction of defective work.
- C. Qualification of Testing Agencies:
- 1. Except as otherwise indicated, and except where manufacturer's testing facilities are indicated as acceptable, engage independent testing laboratories specializing in the required services, and complying with "Recommended Requirements for Independent Laboratory Qualification" by American Council of Independent Laboratories (ACIL).
  - D. Reports: Submit test / inspection reports, including agency's analysis of the results and recommendations, where applicable, in duplicate, except as otherwise indicated, and submit copies directly to the governing authorities where required or when requested.

1.8 DAMAGE CLAIMS

- A. The Contractor will be responsible for adequately securing materials stored at the Project Site, and the work in progress, and to conduct the work in such a way as to not create undue risk of injury or damage to persons or property. It is required that the Contractor adequately fence and sign the Project Site, as necessary, and /or arrange and provide for security personnel to adequately keep unauthorized persons from entering the construction area at any hour of the day or night. Notwithstanding anything to the contrary in the General Conditions, and without limiting the generality of anything contained in the General Conditions, Drawings or Specifications, the Contractor is responsible for all damages to persons and property, including damage to the work of other contractors, that occurs as a result of the Contractor's negligence or the negligence of its employees, agents, representatives, or subcontractors upon the Project, in connection with its operations, use of the Project, or prosecution of the work. The Contractor will indemnify and hold harmless the Owner and all of its officers, agents, employees and consultants from any liability, claims, demands or causes of action of any nature whatsoever for damages of any kind, as above set forth, and the Contractor agrees, at its expense, to defend any legal or other action brought against the Owner founded upon such liability, claim, demand or cause of action and to pay any attorneys' fees incurred by the Owner in connection therewith.

1.9 COORDINATION WITH OTHER CONTRACTORS

- A. Schedule work activity in coordination with all on-site contractors; make adjustments in work activities to accommodate the requirements of other contractors.

PART 2 PRODUCTS

Not Used

PROCEDURES AND CONTROLS 01205-3

the load-carrying capacity or load / deflection ratio; submit proposed cutting and patching of structural elements to the Owner's representative / Architect / Engineer for structural approval before proceeding. Do not cut-and-patch operational elements and safety related components in a manner that will result in decreased operational life, increased maintenance, or decreased safety. Do not cut-and-patch work which is exposed on the exterior or exposed in occupied spaces, in a manner that will result in the reduction of visual qualities or result in substantial evidence of cut-and-patch work, both as judged solely by the Architect. Remove and replace work judged to be cut-and-patched in a visually unsatisfactory or otherwise objectionable manner.

- B. Materials: Except as otherwise indicated or approved, provide materials for cutting-and-patching which will result in equal-or-better work than the work being cut-and-patched, in terms of performance characteristics, and including visual effect, where applicable. Use materials identical to the original materials where feasible, and where recognized that satisfactory results can be produced thereby.
- C. Temporary Support and Protection: Provide adequate temporary support for work to be cut, to prevent failure. Do not endanger other work. Provide adequate protection of other work during cutting-and-patching, to prevent damage, and provide protection of the work from adverse weather exposure.
- D. Cut work by methods least likely to damage work to be retained and adjoining work.

1. Where physical cutting action is required, cut the work with sawing and grinding tools, not with hammering and chipping tools. Core drill openings through concrete work.
2. Comply with the requirements of applicable Division 2, Specifications Sections where cutting-and-patching requires excavating and backfilling.

E. Restore exposed finishes of patched areas, and, where necessary, extend the finish restoration onto the adjoining retained work, in a manner which will eliminate evidence of patching.

1. Where patching occurs in a smooth, painted surface, extend the final paint coat over the entire unbroken surface containing the patch after the patched areas have received prime and base coats.

### 3.3 CLEANING AND PROTECTION

A. General: During handling and installation of work at the Project Site, clean and protect work in progress and the adjoining work on a basis of perpetual maintenance. Apply suitable protective covering over newly installed work where reasonably required to ensure freedom from damage and deterioration at the time of substantial completion; otherwise, clean and perform maintenance on newly installed work as frequently as necessarily throughout the remainder of the construction period. Adjust and lubricate operable components to ensure operability without damaging effects.

B. Limiting Exposures of Work: To the extent possible through reasonable control and protection methods, supervise performance of the work in a manner and by means which will ensure that none of the work, whether completed or in progress, will be subjected to harmful, dangerous, damaging, or otherwise deleterious exposures during the construction period.

END OF SECTION

PROCEDURES AND CONTROLS

01205-5

### SECTION 01310

#### PROJECT MANAGEMENT AND COORDINATION

##### PART 1 GENERAL

###### 1.1 SUMMARY

A. Section Includes:

1. Administrative and supervisory personnel.
2. Submittals.
3. Contractor's quality control.
4. Coordination.
5. Project coordination.
6. Pre-Construction meeting.
7. Progress meetings.
8. Pre-Installation meetings.
9. Schedule of Values.

B. Related Documents: The Contract Documents, as defined in Section 01010 - Summary of Work, apply to the work of this Section. Additional requirements and information necessary to complete the work of this Section may be found in other Documents.

###### 1.2 ADMINISTRATIVE AND SUPERVISORY PERSONNEL

A. Project Coordination Administrator: Contractor's Representative experienced in administration, supervision, and quality control of building construction similar to the work of this Project, including mechanical, plumbing and electrical work.

B. Project Field Superintendent: Contractor's Representative experienced in general field supervision of building construction similar to the work of this Project including finish work, mechanical, plumbing and electrical work; to supervise, direct, inspect and coordinate work of the Contractor, subcontractors, suppliers and installers, and expedite the work to ensure compliance with the Construction Schedule.

###### 1.3 SUBMITTALS

A. Submit a list of the Contractor's principal staff assignments including Project Coordination Administrator, Project Field Superintendent, Quality Control Representative, and other personnel assigned to the Project Site; identify their duties and responsibilities.

B. Submit Shop Drawings, product data, and other required submittals in accordance with Section 01330 - Submittal Procedures, for review and compliance with the Contract Documents.

C. Submit Requests for Information (RFI) and Interpretation of Contract Documents in a

PROJECT MANAGEMENT  
AND COORDINATION

01310-1

timely manner.

#### 1.4 CONTRACTOR'S QUALITY CONTROL

- A. Perform project quality control in accordance with requirements in the Contract and as specified in Section 01450 - Quality Control.
- B. Coordinate the scheduling of inspections and testing required by the individual Specification Sections and in accordance with Section 01450 - Quality Control.

#### 1.5 COORDINATION DRAWINGS

- A. Prepare and distribute coordination drawings where close coordination is required for the installation of products and materials fabricated off-site by separate entities, and where limited space availability requires maximum utilization of space for the efficient installation of different components. Show the interrelationship of components shown on separate Shop Drawings. Indicate the required installation sequences.

#### 1.6 PROJECT COORDINATION

- A. Coordinate construction activities and the work of all trades under various Sections of these Specifications and work of the Contract to facilitate the orderly installation of each part of the work. Coordinate construction operations included under different Sections of the Specifications and the Contract that are dependent upon each other for proper installation, connection and operation.
- B. Coordinate the construction activities of this Contract with Contractors retained separately from the Owner.
- C. Where installation of one part of the work is dependent upon installation of other components, either before or after that part of the work, schedule construction activities in a sequence to obtain an uninterrupted installation.
- D. Obtain drawings, manufacturer's product data, instructions, and other data to provide a proper and complete installation.
  - 1. Check field dimensions prior to installing products. Verify necessary clearances and means of access for equipment from storage to the final position.
  - 2. Make data and information available to all trades involved.
- E. Ensure that utility requirements of operating equipment are compatible with the building utilities. Coordinate the work of various Specification Sections for installation and final connection of the equipment.
  - 1. Ensure that mechanical, plumbing and electrical rough-ins have been installed and are properly sized and located.
- F. Coordinate space requirements and the installation of mechanical, plumbing and electrical work indicated diagrammatically on the Drawings. Follow the routing shown for pipes, ducts, conduits and wiring as closely as possible; make runs parallel with the lines of the building. Utilize spaces efficiently to maximize accessibility for other installations, for maintenance, and for repairs.
- G. Where space is limited, coordinate the installation of different components to ensure maximum accessibility for required maintenance, service and repairs.

PROJECT MANAGEMENT  
AND COORDINATION 01310-7

- H. Provide for installation of items scheduled for future installation.
- I. Where necessary, prepare memoranda for distribution to each party involved outlining special procedures required for coordination. Prepare memoranda for the Owner's representative, separate contractors, where coordination of their work is required.
- J. In finished areas, conceal pipes, ducts, conduit and wiring within the construction. Coordinate the location of fixtures and outlets with finish elements.
- K. Coordinate completion and clean up of the work of the separate Sections in preparation for completion of the Project.
- L. After occupancy, coordinate access to the Site for correction of defective work and work not in accordance with the Contract Documents, to minimize disruption of the Owner's / Tenant's activities.

#### 1.7 PRE-CONSTRUCTION MEETING

- A. The Owner's representative will schedule a Pre-Construction Meeting after issuance of a Notice to Proceed.
- B. Attendance: Owner's representative, Architect, Engineer, Contractor, Project Superintendent and Contractor's Quality Control Representative and other contractors retained by the Owner.
- C. Agenda:
  - 1. Submission of executed Bonds and Insurance Certificates.
  - 2. Distribution of Contract Documents.
  - 3. Submission of the Schedule of Values.
  - 4. Designation of personnel representing the parties to the Contract.
  - 5. Procedures and processing of Requests for Information (RFI), field decisions, submittals, substitutions, applications for payment, change proposals, Change Orders, and contract closeout procedures.
  - 6. Scheduling.
  - 7. Construction facilities and temporary controls.
- D. The Contractor will record minutes of the meeting and distribute copies to the participants and 1 those affected by the decisions made.

#### 1.8 PROGRESS MEETINGS

- A. The Contractor will schedule and administer meetings throughout progress of the work at intervals to be determined.
- B. The Contractor will make arrangements for meetings, prepare an agenda, distribute copies to participants and preside over the meetings.
- C. Attendance: Job Superintendent, Contractor's Quality Control Representative, major

PROJECT MANAGEMENT  
AND COORDINATION 01310-3

subcontractors and suppliers, Architect and the Owner's representative, engineers and subcontractors as appropriate to the agenda for each meeting.

D. Agenda:

1. Minutes of previous meetings.
2. Work progress.
3. Status of payments.
4. Field observations, problems, and decisions.
5. Submittals Schedule and the status of submittals.
6. Status of off-site fabrications and delivery schedules.
7. Progress Schedule.
8. Corrective measures to regain projected schedules, if necessary.
9. Planned progress during the succeeding work period.
10. Quality and work standards and pre-installation meetings.
11. Pending change proposals and effect of proposed changes on the progress schedule, and coordination.
12. Other business relating to the work.

D. The Owner's representative will record the minutes and distribute copies to the participants.

1.9 PRE-INSTALLATION MEETING

A. When required by an individual Specifications Section, or as determined necessary by the Owner's representative, convene a Pre-Installation Meeting at the Project Site prior to commencing the work of that Section.

B. Require attendance of the parties directly affecting, or affected by the work of the specific Specifications Section.

C. Notify the Architect seven (7) days in advance of the meeting date.

D. Prepare an agenda and preside at the meetings:

1. Review requirements of the Contract Documents, conditions of installation, preparation, and installation procedures.
2. Review coordination with related work.

E. The Contractor shall record minutes of the meetings and distribute copies to the participants and those affected by the decisions made.

1.10 SCHEDULE OF VALUES

A. Prior to submittal of the first payment application, submit a construction cost breakdown to the Architect in a form and format acceptable to the Architect.

PART 2	PRODUCTS Not Used.
PART 3	EXECUTION Not Used.

END OF SECTION

PROJECT MANAGEMENT  
AND COORDINATION

01310-4

PROJECT MANAGEMENT  
AND COORDINATION

01310-5

SECTION 01330

SUBMITTAL PROCEDURES

PART 1 GENERAL

1.1 SUMMARY

- A. Section Includes:
  - 1. Submittal procedures.
  - 2. Product data, Shop Drawings, samples and miscellaneous work.
  - 3. Assurance / Control submittals.
    - a. Certificates.
    - b. Manufacturer's installation instructions.
  - 4. Owner representative's action.
- B. Related Documents: The Contract Documents as defined in Section 01010 - Summary of Work, apply to the work of this Section. Additional requirements and information necessary to complete the work of this Section may be found in other Documents.

1.2 DEFINITIONS

- A. Product Data: Includes manufacturer's standard printed information on materials, products and systems; not especially prepared for this Project, other than the designation of selections from among available choices printed therein.
- B. Shop Drawings: Include specially-prepared technical data for this Project, including drawings, details, diagrams, performance curves, data sheets, schedules, templates, patterns, reports, calculations, instructions, measurements and similar information not in standard printed form.
- C. Samples: Include both fabricated and unfabricated physical examination of materials, products and units of work; both as competed units and as smaller portions of units of work; either for limited visual inspection or, where indicated, for more detailed testing and analysis.
- D. Mock-Ups: A special form of samples, which are too large or otherwise inconvenient for handling in the specified manner for transmittal of sample submittals.
- E. Design Calculations: As required to show that component parts of a system meet the design criteria and performance requirements. Manufacturer's published calculations or as certified by a professional engineer. Subject to approval of the Owner's representative, manufacturer or fabricator certifications may be accepted in lieu of calculations.
- F. Miscellaneous Submittals: Includes warranties, maintenance agreements, workmanship bonds, project photographs, survey data and reports, physical work records, quality testing

and field measurement data, operating and maintenance materials, extra and overrun stock, devices and similar information; applicable to the work and not processed as product data, shop drawings or samples.

1.3 SUBMITTALS

- A. Submit two (2) copies of a proposed Schedule of Submittals to the Owner's representative within 30 days after receipt of a Notice to Proceed. List all items requiring submittal for review and approval by the Architect - Engineer / Owner's representative.
- B. Schedule of Submittals. Include the following:
  - 1. Indicate the type of submittal: Product Data, Shop Drawing, sample, certificate, warranty, technical representative's report or other submittal.
  - 2. Identify the Specifications Section number, Section paragraph number where the item is specified and a description of the item being submitted.
  - 3. Indicate the scheduled date for initial submittal, date for approval and date for possible re-submittal for each required submittal.
- C. Coordinate the Schedule of Submittals with the Construction Schedule.

1.4 SUBMITTAL PROCEDURES

- A. General:
  - 1. Coordination and Sequencing: Coordinate the preparation and processing of submittals with performance of the work so that the work will not be delayed by submittals. Coordinate and sequence different categories of submittals of the same work, and or interfacing units of work, so that one will not be delayed by coordination of the submittal review with another.
  - 2. Transmit each submittal to the Owner's representative on an Owner-approved transmittal form.
  - 3. On the Transmittal form, provide a place to indicate the Project name, date, <sup>A</sup>To, <sup>®</sup>, <sup>A</sup>From, <sup>®</sup>; names of the Contractor, subcontractors, suppliers, manufacturers, pertinent drawings(s), detail number(s), Specifications Sections, category and type of submittal, purpose, description, distribution record (for both transmittal and submittals), and signature of the transmitter.
  - 4. Identify variations from the Contract Documents and product or system limitations which may affect successful performance of the completed work.
  - 5. Apply the Contractor's stamp, signed or initialed certifying that review, verification of the products required, field dimensions, adjacent construction work and the coordination of information, is in accordance with requirements of the work and the Contract Documents.
  - 6. Provide space for the Owner representative's remarks and <sup>A</sup>Action stamp.
  - 7. Sequentially number each transmittal form. Provide the original number and a sequential alphabetic suffix on each re-submittal.
  - 8. Package each submittal appropriately for transmittal handling.

SUBMITTAL PROCEDURES

01330-1

SUBMITTAL PROCEDURES

01330-2

dimensions and notes based on field measurements. Identify materials and products in the work shown. Provide key plans or cross reference to room numbers to identify the location of multiple elements. Indicate compliance with standards and special coordination requirements. Identify deviations from the Contract Documents, check dimensions; check that trades have been coordinated and that no conflict will develop in its installation.

2. Indicate special utility and electrical characteristics, utility connection requirements, and location of utility outlets for service to functional equipment and appliances.
3. Shop Drawings: Submit for review. After review, produce copies and distribute in accordance with SUBMITTAL PROCEDURES above.
4. Submit in the form of one (1) translucent reproducible transparency and two (2) blue-line or blackline prints. The transparency will be returned to the Contractor after review.
5. Do not allow copies of shop drawings without appropriate final Action® markings by the Owner's representative to be used in connection with the work.

D. Samples:

1. Submit samples to illustrate the functional and aesthetic characteristics of the product, with integral parts and attachment devices. Coordinate sample submittals for interfacing work.
2. Include full Project information on each sample submitted.
3. Provide units identical to the final condition of the proposed materials or products of the work. Include Arrange® samples of not less than three (3) units where unavoidable variations must be expected, and describe or identify variations between the units of each set. Provide a full set of optional samples where selection is required. Include information with each sample to show generic description, source or product name and manufacturer, limitations, and compliance with standards. Submit samples for review and confirmation of color, pattern, texture, and Akind®.
4. Submit samples of finishes in the available colors, textures and patterns.
5. Submit the number of samples specified in the individual Specifications Sections; a minimum of two (2), one of which will be retained by the Owner's representative. At Contractor's option, provide preliminary submittal of a single set of samples for review and Action®. Otherwise, initial submittals will be considered the final submittal unless returned with an Action® mark that requires re-submittal. Submit three (3) sets of samples in the final submittal; two (2) sets will be returned.
6. Maintain one (1) final set of samples at the Project Site, in suitable condition and available for quality control comparisons.
7. The Owner's representative will not Atest® samples, except as otherwise indicated, for compliance with other requirements, which are the responsibility of the Contractor.

SUBMITTAL PROCEDURES 01330-4

9. Schedule submittals to comply with the scheduling requirements of the Construction Schedule.
10. On each re-submittal, identify all changes made since the previous submission.
11. Distribute copies of reviewed submittals to the field, subcontractors and suppliers, as appropriate. Instruct the parties to promptly report any inability to comply with the provisions.
12. Submittals not required will not be processed.
13. Submittals received from sources other than through the Contractor's office will be returned Awithout action®.
14. Except as otherwise indicated in individual Specifications Sections, comply with the requirements specified herein for each indicated category of submittal. Provide and process intermediate submittals, where required between the initial and final submittals, similar to initial submittals.

B. Product Data:

1. Collect required data into one submittal for each unit of work or system; mark each copy to show which choices or options are applicable to the Project.
2. Include manufacturer's standard printed information such as catalog cuts, manufacturer's published instructions, standard color charts, roughing-in diagrams and templates, standard wiring diagrams, performance curves and other similar items. Include manufacturer's standard printed recommendations for application and use, compliance with standards, application of labels and seals, notation of field measurements which have been checked, and special coordination requirements.
3. Mark each copy to identify the applicable products, models, options, and other data. Supplement the manufacturers' standard data with information unique to this Project.
4. Indicate product utility and electrical characteristics, utility connection requirements, and the location of utility outlets for service to functional equipment and appliances.
5. Submit the number of copies the Contractor requires, plus four (4) copies to be retained by the Owner's representative. Submit six (6) sets of product data; three (3) sets will be returned. Maintain one (1) set of product data at the Project Site, available for reference.
6. Do not submit product data or permit its use on the Project until compliance with requirements of the Contract Documents has been confirmed by the Contractor.
7. Do not proceed with the installation of materials, products or systems until the final copy of applicable product data is in the possession of the installer.

C. Shop Drawings:

1. Provide newly prepared information on reproducible sheets, with graphic information at accurate scales, and with the name of the preparer indicated. Show

SUBMITTAL PROCEDURES 01330-3

8. Returned samples intended or permitted to be incorporated into the work are so indicated in the individual Specifications Sections Samples; must be in an undamaged condition at the time of acceptance.

E. Mock-Ups:

1. Mock-ups and similar samples indicated in individual Specifications Sections are recognized as a special type of sample. Comply with the requirements for <sup>Δ</sup>samples<sup>Δ</sup>, to the greatest extent possible, and process transmittal forms to provide a record of activity.

F. Certificates:

1. When specified in individual Specifications Sections, submit certification by the manufacturer Owner's representative in the quantities specified in Product Data above.
2. Indicate that the material or product conforms to or exceeds the specified requirements. Submit supporting reference data, affidavits and certifications as appropriate.
3. Certificates may be recent or previous test results on materials or products, but must be acceptable to the Owner's representative.

G. Inspection and Test Reports:

1. Classify each as either <sup>Δ</sup>product data<sup>Δ</sup> or <sup>Δ</sup>shop drawing<sup>Δ</sup>, depending upon whether the report is uniquely prepared for the Project or a standard publication or workmanship control testing at the point of production. Process accordingly.

H. Manufacturer's Installation Instructions:

1. When specified in individual Specification Sections, submit printed instructions for delivery, storage, assembly, installation, adjusting, and finishing in the quantities specified in Product Data above.
2. Indicate special procedures, perimeter conditions requiring special attention and special environmental criteria required for the application or installation.

I. Warranties:

1. Refer to individual Specifications Sections for specific general requirements on warranties, product / workmanship bonds, and maintenance agreements. In addition to copies for the Contractor's use, furnish two (2) additional executed copies. Furnish two (2) additional copies when required for the maintenance manuals.

J. Standards:

1. Where copy submittal is indicated, and except where specified integrally with <sup>Δ</sup>Product Data<sup>Δ</sup>, submit two (2) copies for the Owner representative's use. Where workmanship at the Project Site and elsewhere is governed by standards, furnish additional copies to the fabricators, installers and others involved in performance of the work.

K. Closeout Submittals:

2. Refer to individual Specifications Sections and to <sup>Δ</sup>closeout<sup>Δ</sup> paragraphs for specific requirements on submittal of closeout information, materials, tools and similar items.

L. Record Document Copies:

1. Submit one (1) set.
- M. Maintenance / Operating Manuals:
1. Submit two (2) bound sets.

N. Materials and Tools:

1. Refer to individual Specifications Sections for the required quantities of spare parts, extra and overrun stock, maintenance tools and devices, keys, and similar physical units to be submitted.

O. Administrative Submittals:

1. Submit three (3) copies. No copies will be returned.

P. General Distribution:

1. Provide additional distribution of submittals to the subcontractor, suppliers, fabricators, installers, governing authorities and others as necessary for proper performance of the work. Include such additional copies in the transmittal when required to receive an <sup>Δ</sup>Action<sup>Δ</sup> marking before final distribution. Record distributions on the transmittal forms.

1.5 OWNER REPRESENTATIVE'S ACTION

A. For submittals where action and return is required or requested, the Owner's representative will review each submittal, mark to indicate the action taken, if any, and return promptly, generally within 20 days, excluding delivery time to and from the Contractor. When a submittal is to be reviewed by an off-island consultant or when it must be held for coordination, 25 days will be required for review.

1. Compliance with the specified characteristics is the Contractor's responsibility.
2. No action will be taken on submittals for information, closeout documents, record documents and other submittals for similar purposes.

B. Action Stamp: Owner's representative will stamp each submittal to be returned to the Contractor with a uniform, self-explanatory <sup>Δ</sup>Action<sup>Δ</sup> stamp. The stamp will be appropriately marked, as follows, to indicate the action taken:

1. "Accepted" or <sup>Δ</sup>Approved<sup>Δ</sup>: Final Unrestricted Release. When a submittal is marked "Accepted" or <sup>Δ</sup>Approved<sup>Δ</sup>, that part of the work covered by the submittal may proceed provided it complies with the requirements of the Contract Documents; final acceptance will depend upon that compliance.
2. "Accepted<sup>Δ</sup> or <sup>Δ</sup>Approved as Noted": Final-But-Restricted Release. When a submittal is marked "Accepted" or <sup>Δ</sup>Approved as Noted", that part of the work

SUBMITTAL PROCEDURES 01330-5

SUBMITTAL PROCEDURES 01330-6



covered by the submittal may proceed provided it complies with the notations and corrections marked on the submittal and meets requirements of the Contract Documents; final acceptance will depend on that compliance.

3. "Rejected or Disapproved: Submit Specified Item" or "Revise and Resubmit": Returned for Re-submittal. When a submittal is marked "Rejected or Disapproved: Submit Specified Item", or "Revise and Resubmit," do not proceed with the work covered by the submittal, including purchasing, fabrication, delivery or other activity. Revise or prepare a new submittal in accordance with the notations; re-submit without delay. Repeat as necessary to obtain an acceptable action mark.

- a. Do not permit submittals marked "Rejected or Disapproved: Submit Specified Item" or "Revise and Resubmit" to be used at the Project Site or elsewhere where work is in progress.

4. "Returned: Not Required": Where a submittal is primarily for information or record purposes, special processing or other activity, the submittal will be returned, marked "Returned: Not Required".

- C. Any review and approval by the Owner's representative of any Product Data, Shop Drawings, or Samples is only for conformance to the general design concept of the work and does not extend to consideration of structural integrity, safety, detailed compliance with the Contract Documents or any other obligation of the Contractor. Review and approval of any such data does not relieve the Contractor from its obligation to meet his requirements under the Contract Documents, not shall it give rise to any claim in favor of the Contractor or any third party against the Owner.

PART 2 PRODUCTS

Not Used.

PART 3 EXECUTION

Not Used.

END OF SECTION

SECTION 01440

REQUESTS FOR INFORMATION

PART 1 GENERAL

1.1 DESCRIPTION OF WORK

- A. Administrative requirements for RFI's.

1.2 DEFINITIONS

- A. Request for Information (RFI): Contractor's written request for information to confirm, re-verify, or clarify the intent required by the Contract Documents.

1.3 SUBMITTALS

- A. Submit RFI's on the Contractor's standard form.

1.4 QUALITY ASSURANCE

- A. Architect's Intent: It is a condition of the Contract for Construction, that prior to signing of the Contract, the Contractor be fully familiar with and clear as to the requirements (Architect's design intent) for this Project as presented in the Contract Documents. It is also a condition of the Contract, that prior to signing of the Contract, should there be any aspect of the Contract which is not clear or not complete enough, that the Contractor secure the necessary information from the Architect in order to attain the required understanding of the Project. The primary reasons for this is so the Owner can receive a fair and complete cost proposal for the Work, without hidden or additional costs and to minimize unnecessary costs to administer the Project during progress of the Work.

- B. Architect's Drawings and Specifications

1. Design Intent: It is an accepted historical and understood practice in the industry that the Architect's Drawings and Specifications reasonably and professionally convey the design intent for the Project without necessarily indicating every single condition for the Work, but to the degree necessary for Contractor's to propose a fair and complete cost for the Work, including for Work not indicated, but implied by the Architect's design intent.

2. RFI's - Basis of Communication: Due to the fact that all conditions are not indicated in the Contract Documents, it is understood that additional clarifications will be necessary during the course of the Work for the Contractor to fully achieve all aspects of the Architect's design intent, and that the RFI procedure becomes the administrative basis by which information is formally conveyed between the Architect and the Contractor.

- C. Misuse of the RFI Process: RFI's are not to be used frivolously, including as a method of enlisting the Architect's services for finding information already indicated in the Contract Documents.

- D. Contractor Initiation: All RFI's must be submitted by the General Contractor.

PART 2 PRODUCTS

REQUESTS FOR INFORMATION 01440-1

01330-7

SUBMITTAL PROCEDURES

SECTION 01450  
QUALITY CONTROL

Not Used.

PART 3 EXECUTION

3.1 CONTRACTOR'S RESPONSIBILITIES

- A. Examination: Upon discovering a potential aspect of the Work which may require further clarification from the Architect, the Contractor shall thoroughly examine the Contract Documents to ensure that the information is not indicated.
- B. Submittal: When a reasonable search for the needed information has been made without success, complete and submit an RFI.

3.2 ARCHITECT'S RESPONSIBILITIES

- A. Review: Not later than ten (10) working days after an RFI is received, return a response to the Contractor on the submittal form.

END OF SECTION

PART 1 GENERAL

1.1 SUMMARY

- A. Section Includes:
  - 1. Owner representative's quality assurance (QA).
  - 2. Contractor's quality control (QC).
  - 3. Quality control procedures.
  - 4. Testing and inspection laboratory services.
  - 5. Contractor's field inspection and testing.
  - 6. Contractor's reports.
  - 7. Contractor's testing and inspection reports.
  - 8. Non-compliance check-off list.
  - 9. Completion and inspection of work.
- B. Related Documents: The Contract Documents, as defined in Section 01010 - Summary of Work, apply to the work of this Section. Additional requirements and information necessary to complete the work of this Section may be found in other Documents.

1.2 REFERENCES

- A. American Society for Testing and Materials (ASTM):
  - 1. ASTM C 802 - Practice for Conducting an Interlaboratory Test Program to Determine the Precision of Test Methods for Construction Materials.
  - 2. ASTM C 1077 - Practice for Laboratories Testing Concrete and Concrete Aggregates for Use in Construction and Criteria for Laboratory Evaluation.
  - 3. ASTM C 1093 - Practice for Accreditation of Testing Agencies for Masonry.
  - 4. ASTM D 3740 - Practice for Minimum Requirements for Agencies Engaged in Testing and / or Inspection of Soil and Rock as Used in Engineering Design and Construction.
  - 5. ASTM D 4561 - Practice for Quality Control Systems for Organizations Producing and Applying Bituminous Paving Materials.
  - 6. ASTM E 329 - Specification for Agencies Engaged in Construction Inspection and / or Testing.

REQUESTS FOR INFORMATION

01440-2

QUALITY CONTROL

01450-

7. ASTM E 543 - Specification for Agencies Performing Nondestructive Testing.
8. ASTM E 699 - Practice for Evaluation of Agencies Involved in Testing, Quality Assurance, and Evaluating of Building Components.
- 1.3 SUBMITTALS
- A. Submit four (4) copies of a proposed Contractor Quality Control Plan within fifteen (15) days after receipt of the Notice to Proceed.
- B. Contractor's Quality Control Plan. Indicate the following:
1. Quality Control Organization: In chart form, showing relationship of the Quality Control organization to other elements of the Contractor's organization.
2. Names and qualifications of personnel in the Quality Control organization, including the Contractor's Quality Control Representative, inspectors, independent testing and inspection laboratory, independent fire alarm test and certification agency, independent fire sprinkler test and certification agency, independent HVAC test and balance agency, etc.
3. Procedures for reviewing coordination drawings, Shop Drawings, certificates, certifications and other submittals.
4. Testing and Inspection Schedule, keyed to the Construction Schedule, indicating tests and inspections to be performed, names of persons responsible for the inspection and testing for each segment of the work, including preparatory, initial and follow-up.
5. Proposed forms to be used including Contractor's Daily Report, Contractor's Test and Inspection Report, and Non-Compliance Check-Off List.
- C. Independent Testing and Inspection Laboratory. Submit the following:
1. Name.
2. Address.
3. Telephone number.
4. Name of full-time registered Engineer.
- 1.4 OWNER REPRESENTATIVE'S QUALITY ASSURANCE
- A. The Owner's representative will inspect the quality of work being installed, review and verify the accuracy of changes in the work, receive and distribute the Contractor's submittals, determine compliance with the Contract Documents and preside at progress and coordination meetings.
- B. The Owner's representative will arrange for factory tests when needed; at the Contractor's cost.
- C. Owner's Field Inspection: The Owner's representative will perform inspections of the work for quality assurance (QA).

QUALITY CONTROL

01450-2

1.5 CONTRACTOR'S QUALITY CONTROL REPRESENTATIVE

- A. Qualifications for Contractor's Quality Control Representative: Minimum five (5) years construction quality control or construction management experience on work similar to the work of this Contract.

1.6 CONTRACTOR'S QUALITY CONTROL

- A. The Contractor is responsible for the overall quality of the work performed by the Contractor and subcontractors working under this Contract. The quality of any part of the work must not be less than that required by the Contract Documents. If the Owner's representative determines that the quality of the work does not conform to the Contract Documents, the Owner's representative will notify the Contractor, in writing. The Contractor must correct the identified deficiencies and advise the Owner's representative of the corrective action taken within 7 days of the date of notification.
- B. Monitor quality control over the Contractor's staff, subcontractors, suppliers, manufacturer's, products, services, site conditions and workmanship.
- C. Comply fully with the manufacturer's published instructions, including each step in the sequence of installation.
- D. Should the manufacturer's published instructions conflict with the Contract Documents, request clarification from the Owner's representative before proceeding.
- E. Comply with the specified standards as a minimum quality for the work, except where more stringent tolerances, codes or specified requirements indicate higher standards or more precise workmanship.
- F. Perform the work by persons who are thoroughly qualified and trained in their respective trade to produce workmanship of the specified quality.
- G. Secure products in place with positive anchorage devices, designed and sized to withstand wind and seismic loads, stress, vibration, physical distortion and disfigurement.
- H. Perform tests required by governing authorities and utility agencies having jurisdiction.
- I. Contractor's Field Inspection: The Contractor or his authorized representative(s) shall inspect all work under this Contract for quality control (QC).

1.7 QUALITY CONTROL TESTING:

- A. Field tests made at, or in the vicinity of the Project Site in connection with the actual construction, including but not limited to, concrete batch plants, asphalt batch plants and similar establishments directly involved in the construction process.
1. Field Tests by the Contractor: The Contractor shall perform all field testing specifically required of him in the Contract Specifications and all field tests required by Applicable Publications<sup>®</sup> referenced in the Contract Specifications. The cost of testing shall be borne by the Contractor. The Contractor shall furnish all equipment, instruments, qualified personnel and facilities necessary to perform all tests required by the Contract Documents. The required testing services shall be performed by the Contractor or acquired by the Contractor through a qualified commercial testing laboratory. If a commercial testing laboratory is retained to perform tests under this Contract, all test reports shall be certified by the

QUALITY CONTROL

01450-3

laboratory. Test reports shall include the acceptable value for each specification item, actual test results obtained, methods used, and a statement that the product, equipment or system conforms or does not conform to the Specifications requirements.

2. Field Tests by Owner: Field tests conducted by the Owner will be made as necessary to assure quality or as otherwise provided herein.

B. Factory tests made at the point of manufacture of various products shipped to the Project Site as a unit.

C. Certified tests made by approved testing agencies on material and / or equipment to be incorporated into the Project under the Contract. These tests are those performed by Factory Mutual, Underwriters' Laboratories, Inc., and others.

1. Manufacturer's Certified Tests: Certified tests on materials to be incorporated into the work will be acceptable, provided they are performed by the manufacturer or by Owner's representative approved agencies or laboratories, show that the materials conform to the Specifications, and that tests and certifications meet the requirements of the paragraph entitled "Quality Assurance" below.

#### 1.8 TESTING AND INSPECTION LABORATORY SERVICES

A. Selection and Payment:

1. Employment and payment for services of an Independent Testing and Inspection Laboratory to perform specified testing and inspection shall be by the Contractor.

2. Owner Approval of Laboratories: All laboratory work performed under this Contract shall be done by a Laboratory approved by the Owner's representative, whether the laboratory is employed by the Contractor or by others, or is owned and operated by the Contractor. The basis of approval includes the following:

- a. Laboratories performing work in connection with concrete, steel and bituminous material must conform to American Society for Testing and Materials (ASTM) E 329.
- b. Laboratories performing work not in connection with concrete, steel and bituminous materials must conform to Sections 3 and 4 of ASTM E 329.

3. Employment of Independent Testing and Inspection Laboratory in no way relieves the Contractor of his obligation to perform work in accordance with the requirements of the Contract Documents.

B. Quality Assurance:

1. Comply with the requirements of ASTM C 802, ASTM C 1077, ASTM C 1093, ASTM D 3740, ASTM D 4561, ASTM E 329, ASTM E 543, ASTM E 699 and ASTM E 1691.

2. Laboratory Staff: Maintain a full-time registered Engineer on staff to review the services provided.

3. Testing Equipment: Calibrated at reasonable intervals with devices of and accuracy traceable to either National Bureau of Standards or accepted values of natural physical constraints.

QUALITY CONTROL

01450-4

C. Laboratory Responsibilities:

1. Test samples of mixes submitted by the Contractor.
2. Provide qualified personnel at the Project Site. Cooperate with the Owner's representative and the Contractor in the performance of services.
3. Perform the specified sampling, testing and inspection of products in accordance with the specified standards.
4. Determine compliance of the materials and mixes with requirements of the Contract Documents.
5. Promptly notify the Contractor's Quality Control Representative and the Owner's representative of observed irregularities or non-conformance of work or products.
6. Perform additional tests as required by the Owner's representative.

#### 1.9 CONTRACTOR'S FIELD INSPECTION AND TESTING

A. Contractor: Test and inspect the work provided under this Contract to ensure that the work is in compliance with the Contract requirements. Required tests and inspections are indicated in the individual Specifications Sections.

B. Preparatory Inspection: Performed prior to beginning the work and prior to beginning each segment of work and includes:

1. Review of Contract requirements.
2. Review of Shop Drawings and other submittal data after approval and return.
3. Examination to assure that the materials and equipment conform to the Contract requirements.
4. Examination to assure that the required preliminary or preparatory work is complete.

C. Initial Inspection: Performed when a representative portion of each segment of the work has been completed, and includes:

1. Performance of the required tests.
2. Quality of the workmanship.
3. Review for omissions and dimensional errors.
4. Examination of products used, connections and supports.
5. Approval or rejection of the inspected segment of work.
- D. Follow-Up Inspections: Performed daily and more frequently, as necessary, to ensure that non-complying work has been corrected.

E. Testing and Inspection: Perform testing and inspection in accordance with requirements of the individual Specifications Sections.

QUALITY CONTROL

01450-5

stating specifically what is non-complying, date the faulty work was originally discovered and the date the work was corrected. There is no requirement to report deficiencies corrected the same day the deficiency was discovered. Submit a copy of the Non-Compliance Check-Off List of non-complying work items on a weekly basis for review at the next Progress / Coordination Meeting.

1.10 CONTRACTOR'S WEEKLY REPORTS

- A. Submit weekly reports to the Owner's representative for days that work was performed. Include the following information:
  1. Contractor's name and address.
  2. Job reference and information.
  3. Date, weather, minimum and maximum temperatures, rainfall and other pertinent weather conditions.
  4. Daily workforce of the Contractor and subcontractors, by trade.
  5. Description of the work started, on-going work, and work completed by each subcontractor.
  6. Coordination implemented between the various trades.
  7. Approval of substrates received from various trades.
  8. Non-conforming and unsatisfactory items to be corrected.
  9. Remarks.

1.11 CONTRACTOR'S TESTING AND INSPECTION REPORTS

- A. Prepare and submit a written report of each test and inspection, signed by the Contractor's Quality Control Representative performing the inspection, within two (2) days after the day the inspection was made.
- B. Include the following on the written inspection reports:
  1. Cover sheet prominently identifying that the inspection "CONFORMS" or "DOES NOT CONFORM" to the Contract Documents.
  2. Date of the inspection and date of the report.
  3. Project name, location, solicitation number and Contractor.
  4. Names and titles of individuals making the inspection.
  5. Description of the Contract requirements for inspection by referencing the Specifications Section.
  6. Description of the inspection made, interpretation of the inspection results, and notification of significant conditions at the time of the inspection.
  7. Requirements for follow-up inspections.

1.12 NON-COMPLIANCE CHECK-OFF LIST

- A. Maintain Check-Off List of work that does not comply with the Contract Documents,

1.13 COMPLETION AND INSPECTION OF WORK

- A. Prior to final acceptance by the Owner's representative, submit a certification signed by the Contractor stating that all work has been inspected and that all work, except as specifically noted, is complete and in compliance with the Contract Documents.
- B. Record Documents: By Contractor's Quality Control Representative. Ensure that "Record Documents" required by Section 01780 - Closeout Submittals, are marked to show any deviations made during construction and are kept current on a daily basis. Upon completion of the work, certify the accuracy of the "Record Documents" and submit to the Owner's representative.

PART 2 PRODUCTS

Not Used.

PART 3 EXECUTION

Not Used.

END OF SECTION

QUALITY CONTROL

01450-6

QUALITY CONTROL

01450-7

SECTION 01500  
TEMPORARY FACILITIES AND CONTROLS

PART 1 GENERAL

1.1 SUMMARY

- A. Section Includes:
  - 1. Coordination and Approval.
  - 2. Temporary Utilities: Electrical power, lighting, air conditioning and ventilation, water and sanitary facilities.
  - 3. Fencing.
  - 4. Barriers and Enclosures.
  - 5. Erosion Controls: Surface water control and protection of work.
  - 6. Access Roads and Parking Areas.
  - 7. Project Signs.
  - 8. Field Office and Sheds: Temporary buildings.
  - 9. Construction Aids
  - 10. Progress Cleaning and Waste Removal.
  - 11. Ownership of Temporary Facilities and Controls.
  - 12. Removal of Temporary Construction Facilities and Controls.
- B. Related Documents: The Contract Documents, as defined in Section 01010 - Summary of Work, apply to the work of this Section. Additional requirements and information necessary to complete the work of this Section may be found in other Documents.

1.2 COORDINATION AND APPROVAL

- A. Coordinate with and obtain approval of the Owner's representative for each temporary facility and control, location, sequence and schedule before starting any temporary work.

1.3 ELECTRICAL POWER

- A. Contractor to provide and pay for electrical power from the local power authority; provide generator when island power is not available.
- B. Provide a temporary electric feeder from the electrical service at a location determined by the local power authority and approved by the Owner's representative.

TEMPORARY FACILITIES AND CONTROLS 01500-1

- C. Provide temporary power panels, wiring and outlets for construction operations with branch wiring and distribution boxes located as required; provide properly sized flexible power cords.

- D. Provide temporary transformers, emergency generators, lines, etc., as necessary for continuous electrical supply to existing buildings affected by the construction of this Project.

1.4 LIGHTING

- A. Provide and maintain lighting for construction operations to achieve a minimum lighting level of 2 footcandles.
- B. Permanent building lighting may be utilized during construction.

1.5 AIR CONDITIONING AND VENTILATION

- A. Provide and pay for cooling devices and cooling, as needed, to maintain the specified conditions for construction operations.
- B. Enclose the building prior to activating the temporary cooling equipment.
- C. Prior to the operation of permanent equipment for temporary purposes, verify that the installation is approved for operation, the equipment is lubricated, ductwork and equipment are clean, unfinished construction procedures will not be detrimental to use of the equipment, and filters are in place. Provide and pay for the operation, maintenance and regular replacement of filters and worn or consumed parts.
- D. Ventilate enclosed areas to assist the cure of materials, dissipate humidity, and prevent the accumulation of dust, fumes, vapors and gases.

1.6 WATER

- A. Provide, maintain and pay for suitable quality drinking water for site personnel.
- B. Provide temporary water lines, maintain and pay for water required for construction, including compaction, grading and dust abatement.

1.7 SANITARY FACILITIES

- A. Provide and maintain required facilities and enclosures.
- B. Comply with regulations of the governing authorities having jurisdiction.

1.8 FENCING

- A. Provide 6' high temporary fence around the entire construction area meeting the requirements, if any, of the Department of Public Works; provide vehicular and pedestrian gates with locks.

1.9 BARRIERS AND ENCLOSURES

- A. Provide barriers to prevent unauthorized entry to construction areas and to protect existing facilities and adjacent properties from damage from demolition and construction

TEMPORARY FACILITIES AND CONTROLS 01500-2

operations in accordance with regulations of OSHA and governing authorities having jurisdiction.

- B. Provide barricades and covered walkways as required by governing authorities having jurisdiction for public rights-of-way.
- C. Protect non-owned vehicular traffic from injury and damage.

1.10 EROSION CONTROL

- A. Provide erosion control measures and facilities satisfactory to the environmental agency having jurisdiction and as required by Section 01560 - Environmental Protection.
- B. Grade the Site to drain. Maintain excavations free of water. Provide, operate and maintain pumping equipment as necessary.
- C. Protect the Project Site from ponding and running water. Provide water barriers as required to protect the Site from soil erosion.

1.11 ACCESS ROADS AND PARKING AREAS

- A. Construct and maintain temporary roads accessing a public thoroughfare to serve the construction area.
- B. Extend or relocate as work progress requires. Provide detours necessary for unimpeded traffic flow.
- C. Provide and maintain access to fire hydrants, free of obstructions.
- D. Parking: Arrange for temporary parking areas to accommodate site personnel's vehicles.
  - 1. When site space is not adequate, provide for off-Site parking.

1.12 PROJECT SIGNS

- A. Provide a 4' x 8' temporary project sign. Use new materials; 3/4" exterior grade plywood with hardwood edge trim; mount on treated 4" x 4" hardwood posts or the fence, as appropriate. Sign design to be provided by the Architect.
- B. Use primer and two coats of exterior paint on the sign background, rear and posts. Use exterior paint for lettering on the face. Have lettering done by a professional sign painter.
- C. Locate the sign(s) as indicated or as directed.
- D. Allow no other signs or advertising of any kind on the Project Site, except safety, directional and warning signs and signs required by law.

1.13 FIELD OFFICE AND SHEDS

- A. Provide a building and sheds adequate in size and accommodation for the Contractor's office and storage.
- B. Provide space for Project meetings with a table and chairs to accommodate 10 persons.
- C. Place the office and sheds at approved locations.

1.14 CONSTRUCTION AIDS

TEMPORARY FACILITIES AND CONTROLS 01500-3

- A. Furnish, install and maintain for the duration of the construction, all scaffolds, shoring, tarpaulins, barricades, canopies, warning signs, steps, bridges, platforms, and other temporary work necessary for proper completion of the Project and protection of the public and site personnel in compliance with relevant OSHA safety and other regulations.

1.15 PROGRESS CLEANING AND WASTE REMOVAL

- A. Maintain areas free of waste materials, debris and rubbish. Maintain the Project Site in a clean and orderly condition.
- B. Remove debris and rubbish from pipe chases, plenums, attics, crawl spaces and other closed or remote spaces prior to enclosing the space.
- C. Broom and vacuum clean interior areas prior to the start of surface finishing and continue cleaning to prevent the accumulation of dust.
- D. Collect and remove waste materials, debris and rubbish from the Site weekly, daily if necessary, or as directed by the Owner's representative, and dispose off-Site.

1.16 OWNERSHIP OF TEMPORARY FACILITIES AND CONTROLS

- A. Items provided by the Contractor under this Section shall remain the property of the Contractor and all shall be removed from the Project Site immediately upon completion of the work.

1.17 REMOVAL OF TEMPORARY CONSTRUCTION FACILITIES AND CONTROLS

- A. Remove temporary utilities, equipment, facilities and materials prior to the Substantial Completion inspection.
- B. Remove temporary underground installations.
- C. Clean and repair damage caused by installations and temporary work.
- D. Restore existing and permanent facilities used during construction to their original condition, as specified.

PART 2 PRODUCTS

Not Used.

PART 3 EXECUTION

3.1 ACCESS PROVISION

- A. Provide ramps, stairs, ladders and similar temporary access elements as reasonably required to perform the work and to facilitate its inspection. Comply with reasonable requests of governing authorities performing inspections. When permanent stairs are available for access during construction, cover finished surfaces with sufficient protection to ensure freedom from damage and deterioration at the time of Substantial Completion.

3.2 SECURITY / PROTECTION PROVISION

TEMPORARY FACILITIES AND CONTROLS 01500-4

SECTION 01560

ENVIRONMENTAL PROTECTION

PART 1 - GENERAL

1.1 DEFINITIONS OF CONTAMINANTS

- A. Sediment: Soil and other debris that has been eroded and transported by runoff water.
- B. Solid Waste: Rubbish, debris, garbage, and other discarded materials resulting from industrial, commercial, and agricultural operations, and from community activities' such material having insufficient liquid content to be free flowing.
- C. Rubbish: A variety of combustible and noncombustible wastes such as ashes, waste materials that result from construction or maintenance and repair work, leaves and tree trimmings.
- D. Chemical Wastes: Includes salts, acids, alkalies, herbicides, pesticides, petroleum-derived products and organic chemicals.
- E. Sewage: Water-carried waste products from residences, public buildings, institutions or other buildings, including excrementitious or other discharge from the bodies of human beings or animals, together with such ground water infiltration and surface water as may be present.
- F. Garbage: Refuse and scraps resulting from preparation, cooling, dispensing, and consumption of food.
- G. Asbestos and Asbestos Materials: Asbestos means actinolite, amosite, anthophyllite, chrysotile, crocidolite, and tremolite. Asbestos materials means asbestos or any material containing asbestos such as asbestos waste, scrap, debris, bags, containers, equipment, and asbestos-contaminated clothing consigned for disposal. Friable asbestos material requires a Waste Disposal Permit. Submit one (1) copy of Guam Environmental Protection Agency (GEPA) permit or license which reflects such agency's approval of the disposal plan as being in compliance with their waste disposal regulations.

1.2 ENVIRONMENTAL PROTECTION REQUIREMENTS

- A. Provide and maintain during the life of the contract, environmental protection as defined herein. Provide environmental protective measures as required to control pollution that develops during normal construction practice.
- B. Provide also environmental protective measures required to correct conditions that develop during the construction of permanent or temporary environmental features associated with the project. Comply with all federal and local statutes and regulations pertaining to environmental protection.

1.3 SUBMITTALS

- A. Environmental protection Plan: Submit two (2) copies of the proposed Environmental Protection Plan (EPP) to the Guam Environmental Protection Agency (GEPA) and 2 copies to the Engineer for review and approval no later than 10 calendar days after receipt of the Notice to Proceed (NTP) with work under this project. Review of the plan by the Engineer and GEPA will be accomplished simultaneously. The Contractor shall not undertake any clearing, grubbing, earthwork, and excavations until the EPP has been approved by the

ENVIRONMENTAL PROTECTION 01560-1

- A. The types of temporary security and protection provisions required include, but is not limited to, fire, protection, barricades, warning signs / lights, site enclosure fence, building enclosure / lockup, watchman service, personnel security program (theft prevention), environmental protection, and similar provisions intended to minimize property losses, personal injuries and claims for damages at the Project Site.

3.3 EXTERIOR CLOSURES

- A. Temporarily close exterior openings, weather-tight, to provide acceptable working conditions and for the protection of products, to allow for the maintenance of required ambient temperatures identified in the individual Specifications Sections, and to prevent the entry of unauthorized persons. Provide access doors with self-closing hardware and padlocks.

3.4 PROTECTION OF INSTALLED WORK

- A. Protect installed work and provide special protection where specified in individual Specifications Sections.
- B. Provide temporary and removable protection for installed work. Control activity in the immediate area to prevent damage.
- C. Protect finished floors, and other surfaces from traffic, dirt, wear, damage and movement of heavy objects by covering with durable sheet materials.
- D. Prohibit traffic and storage of materials on waterproofed and finished roof surfaces. If traffic or activity is necessary, obtain recommendations for protection from the waterproofing or roofing material manufacturer.
- E. Prohibit traffic from landscape areas into interior work areas.

3.5 PERMANENT FIRE PROTECTION

- A. Complete each fire protection facility at the earliest reasonable date, make ready for emergency use, and inform site personnel of its availability and proper use.

END OF SECTION

TEMPORARY FACILITIES AND CONTROLS 01500-5



GEPA and the Engineer.

- B. Solid Waste Disposal Permit: Submit one (1) copy of local permit or license which reflects Guam Environmental Protection Agency's (GEPA) approval of the disposal plan as being in compliance with their solid waste disposal regulations.
- C. The Contractor shall prepare an Environmental Protection Plan (EPP) / Erosion Control Plan (ECP) including a Stormwater Pollution Prevention Plan (SWPPP) based on the Contractor's proposed sequence of work, and shall obtain approval of the plan from the Guam Environmental Protection Agency (GEPA) and submit all required Notice of Intent (NOI) to the United States Environmental Protection Agency for compliance with the Guam National Pollutant Discharge Elimination System (NPDES) permit. The EPP shall include all requirements of GEPA including but not limited to Solid and Hazardous Waste Disposal Plan and Fugitive Dust Control Plan to obtain all related permits.

PART 2 - PRODUCT (Not Used)

PART 3 - EXECUTION

3.1 PROTECTION OF NATURAL RESOURCES: The natural resources within the project boundaries and outside the limits of permanent work performed under this contract shall be preserved in their existing condition or restored to an equivalent or improved condition upon completion of the work. Confine construction activities to areas defined by the work schedule, drawings, and specifications.

- A. Land Resources: Except in areas indicated to be cleared, do not remove, cut, deface, injure, or destroy trees or shrubs without special permission from the Engineer.
- B. Protection: Protect existing trees which are to remain and which may be injured, bruised, defaced, or otherwise damaged by construction operations. Remove displaced rocks from un-cleared areas. Protect monuments, markers, and works of art.
- C. Repair or Restoration: Repair or restore to their original condition all trees or other landscape features scarred or damaged by the equipment or operations. Obtain approval of the repair or restoration from the Engineer prior to its initiation.
- D. Temporary Construction: At the conclusion of the project, obliterate all signs of temporary construction facilities such as work areas, stockpiles of excess or waste materials, and all other vestiges of construction.
- E. Water Resources: Perform all work in such a manner that any adverse environmental impact on water resources is reduced to a level acceptable to the Engineer.
- F. Oily and Other Hazardous Substances: Take special measures to prevent oily or other hazardous substances from entering the ground, drainage areas, or local bodies of water.

3.2 CONTROL AND DISPOSAL OF SOLID, CHEMICAL, AND SANITARY WASTES: Pick up solid waste and place in containers which are emptied on a regular schedule. The preparation, cooking, and disposing of food are strictly prohibited on the project site. Conduct handling and disposal of waste to prevent contamination of the site and other areas. On completion, leave areas clean and natural looking. Remove signs of temporary construction and activities incidental to construction of the permanent work in place.

- A. Disposal of Rubbish and Debris: Dispose of rubbish and debris in accordance with the requirements specified herein.  
Remove rubbish and debris from the project site and dispose of it in compliance with federal

ENVIRONMENTAL PROTECTION

01560-2

and local requirements.

- B. Garbage Disposal: Place garbage in appropriate containers and transport such refuse to an approved landfill for disposal at least once per week. As an alternative, the Contractor may arrange for weekly pickup and disposal service either with the Government of Guam or a privately-owned garbage collection service. The Contractor shall pay all fees associated with obtaining and maintaining garbage collection and disposal services.
- C. Sewage, Odor, and Pest Control: Dispose of sewage through connection to the public sewage system. Where such system is not available, use chemical toilets or comparably effective units and periodically empty waste into the public sanitary sewage system. Include provisions for pest control and elimination of odors.
- D. Chemical Waste: Store chemical waste in corrosion resistant containers labeled to identify type of waste and date filled. Remove containers from the project site, and dispose of chemical waste in accordance with federal, state, and local regulations. For oil and hazardous material spills which may be large enough to violate federal and local regulations, notify the Engineer immediately and take measures as instructed by the Engineer or appropriate regulatory agencies, at no additional costs to the Owner.
- E. Petroleum Products: Conduct fueling and lubricating of equipment and motor vehicles in a manner that affords the maximum protection against spills and evaporation. Dispose of lubricants to be discarded and excess oil in accordance with approved procedures meeting federal and local regulations.

3.3

DUST CONTROL: Keep dust down at all times, including non-working hours, weekends, and holidays. Sprinkle or treat with dust suppressors, the soil at the site, haul roads, and other areas disturbed by operations. No dry brooming is permitted. Instead use vacuuming, wet mopping, wet sweeping, or wet power brooming. Air blowing is permitted only for cleaning non-particulate debris, such as steel reinforcing bars. No sandblasting is permitted unless dusts from sandblasting activity are confined. Only wet cutting of concrete blocks, concrete, and asphalt is permitted. No unnecessary shaking of bags is permitted where bagged cement, concrete mortar, and plaster is used.

3.4

NOISE: When available, make the maximum use of "low-noise emission products" as certified by Guam Environmental Protection Agency.

3.5

PEST CONTROL: At the time of final cleaning, engage an experienced exterminator to make an inspection of the project and rid project of rodents, insects, and other pests.

3.6

HISTORIC RESOURCES: Where historic and cultural resources are known to exist within the project construction limits, such resources shall be treated in accordance with the Owner's mitigation plan approved by the Guam Historic Preservation Office (GHPO). When suspected historic resources are encountered during construction, immediately cease all work which will affect such resources. Notify the GHPO, Owner, and Architect and request for instruction.

END OF SECTION

ENVIRONMENTAL PROTECTION

01560-3

SECTION 01567

MAINTENANCE OF TRAFFIC

PART 1 - GENERAL

- 1.1 Traffic control and safety devices shall be in accordance with Part VI of the Manual on Uniform Traffic Control Devices (MUTCD) For Streets and Highways. Latest Edition: U.S. Federal Administration, hereinafter referred to as "the Manual".
- 1.2 Prior to beginning work, the Contractor shall submit to Department of Public Works Traffic Engineering Section approved Traffic Control Plan and a "copy" furnished to the Engineer. The Contractor shall also include a schedule listing the types and number of traffic control and safety devices proposed for use.
- 1.3 Unless otherwise approved or directed by the Engineer, the minimum widths for one-lane and two-lane traffic shall be 10 feet and 20 feet, respectively.

PART 2 - PRODUCTS

- 2.1 Traffic control devices shall conform to the applicable specifications, standards and principles of the Manual except as amended herein. The traffic control devices shall be used at the site for construction, construction survey, and related work that might endanger passing motorists, pedestrians and workers.
  - A. Traffic control devices shall be in place prior to the start of any construction, maintenance, construction survey, and related work and shall be removed until the obstruction or danger of obstruction no longer exists. Where work is performed in stages, there shall be in place those devices that apply to the conditions and activities present during the stage in progress.
  - B. All signs, markers, barricades, cones, lights, and other devices indicating the existence of special conditions and activities shall remain in place until their need is no longer required, unless otherwise directed by the Engineer. Signs that do not apply to existing conditions and activities shall be removed or covered. All devices employed shall be neatly constructed and shall be repaired, cleaned, repainted, and properly maintained in good condition. Special care shall be taken to see that shabby construction materials, equipment, spoil and other obstructions do not obscure any sign, light or barricade, particularly at intersections or curves.
  - C. When it becomes necessary to excavate along or across a highway or any lane thereof, the work shall be performed to avoid existing local peak traffic hours. The Contractor must coordinate this work with DPW.

2.2 SIGNS:

- A. Regulatory signs, warning signs and guide signs used at construction, surveying or other sites shall be reflectorized and shall conform to the basic standards prescribed in the Manual and as specified in the applicable Sections of the Specifications. Generally, signs shall be placed in the most effective locations so as to assure the fastest and most adequate driver response time. All advance warning signs shall be placed on each approach and shall indicate the general character of the work being done, and the distance from the sign to the actual work area.
- B. The Engineer may waive any requirements specified herein if advance application is made by the Contractor when in his judgment, the placement of signs may not be

MAINTENANCE OF TRAFFIC

01567-2

feasible or such placement may interfere with the progress of the work.

2.3 BARRIERS AND CHANNELIZING DEVICES:

- A. Barriers and channelizing devices used at work sites shall follow the basic standards prescribed in the Manual and the following provisions:
  - 1) When it is necessary to confine the traffic to singular lanes, additional transverse barricades and drums shall be placed at close intervals (approximately 120-foot spacing on tangents and curves of more than 500 feet radius and approximately 60-foot spacing on curves of 500 feet radius or less) in the closed lane.
  - 2) Where hazardous locations occur, a series of Type II barricades, cones or drums shall be placed in longitudinal rows along the edge of the closed area (continuously for barricades and at approximately 15-foot spacing for cones and drums).

PART 3 - EXECUTION

- 3.1 Maintaining Traffic: The Contractor shall conduct construction operations with minimum interference to traffic on roads, streets and driveways and he shall have under construction, no greater length or amount of work than he can prosecute properly with due regard to the rights of the public. Roads, streets and driveways shall be kept free of dirt and debris at all times. Convenient access to driveways, houses and buildings along the line of the work shall be maintained. In all areas, the Contractor shall install and maintain appropriate signs, lights, flares and barricades for the protection of the public. Such signs and barricades and their placement shall conform to instructions contained in Part VI of the "Manual on Uniform Traffic Control Devices (MUTCD) for Streets and Highways". The Contractor is expected to be familiar with all applicable Government of Guam Laws and compliance with such laws is considered a part of this contract.
  - 3.2 Coordination:
    - A. In the case of conflict between the Manual and the Specifications, the most stringent requirements shall apply.
    - B. This Section of the specifications shall be coordinated with all related documents affecting the work.
    - C. All work shall be coordinated through the Engineer.

END OF SECTION

MAINTENANCE OF TRAFFIC

01567-1

SECTION 01600  
PRODUCT REQUIREMENTS

PART 1 GENERAL

1.1 SUMMARY

A. Section Includes:

1. Definitions.
2. Products.
3. Product options.
4. Product substitution procedures.
5. Product delivery requirements.
6. Product handling and storage requirements.

B. Related Documents: The Contract Documents, as defined in Section 01010 - Summary of Work, apply to the work of this Section. Additional requirements and information necessary to complete the work of this Section may be found in other Documents.

1.2 DEFINITIONS

- A. Products: Items for incorporation into the work, whether purchased specifically for the Project or taken from previously purchased stock. This term includes the terms material, equipment, systems, and other terms of similar intent.
- B. Named Products: Items identified by manufacturer's name, including make or model number or other designation, as shown or listed in the manufacturer's published product literature.
- C. Materials: Products substantially shaped, cut, worked, mixed, finished, refined, or otherwise fabricated, processed, or installed to form a part of the work.
- D. Equipment: Products with operational parts, whether motorized or manually-operated, that require service connections, such as water piping, waste piping and / or electrical wiring.

1.3 PRODUCTS

- A. Provide products that comply with the Contract Documents, and are new and undamaged at the time of installation.
- B. Provide products complete with accessories, trim, finish, safety guards, and other devices and details required for a complete installation and for its intended use and effect.
- C. Provide products of a kind from a single source. When the products specified are available only from a source that does not, or cannot produce the quantity necessary to

PRODUCT REQUIREMENTS 01600-2

meet the Project requirements, in compliance with the Project Schedule, contact the Architect, in writing, to determine the most important product qualities before proceeding. Qualities may include attributes, such as visual appearance, strength, durability and compatibility. When the Architect makes a determination, select products from a source that produces products that possess those qualities to the greatest extent possible.

1.4 PRODUCT OPTIONS

A. Products: Throughout the Contract Documents products may be specified by a manufacturer's name and catalog number to establish standards of quality and performance, and not for the purpose of limiting competition. Substitute methods and products may be submitted to the Owner's representative for consideration in conformance with the article entitled "Product Substitution Procedures" below.

B. Products Specified by Reference Standards or by Description Only: Any product meeting those standards or description.

C. Products Specified by Naming One or More Manufacturers: Products of manufacturers named and meeting the Specifications requirements. Substitutions may or may not be permitted, as stated in the particular Section specifying the product.

D. Products Specified by Naming One or More Manufacturers with a Provision for Substitutions: Submit a request for substitution for any manufacturer not named, Submit in accordance with the article entitled "Product Substitution Procedures" below.

E. Standards, Codes and Regulations: Where only compliance with an imposed standard, code or regulation is required, selection from among products which comply with the requirements, including those standards, codes and regulations, is the Contractor's option.

F. Performance Requirements and Design Criteria: Provide products which have been produced in accordance with the prescriptive requirements for structural capability, anchorage, mixing, fabricating, curing, finishing, testing and similar operations in the manufacturing process.

G. Prescriptive Requirements: Provide products which have been produced in accordance with the prescriptive requirements using the specified ingredients and components, and complying with the specified testing and similar operations in the manufacturing process.

H. Visual Matching:

1. Where matching with an established sample is required, final judgment of whether a product matches the specified cost category is available, which matches the sample satisfactorily, and complies with requirements, comply with the Contract Document provisions concerning, "substitutions".
2. Visual Selection: Except as otherwise indicated, where specified product requirements include "...as selected from the manufacturer's standard colors, patterns, textures..." or words of similar effect, the selection of manufacturer and basic product is the Contractor's option, and the subsequent selection of color, pattern and texture is by the Architect.

1.5 SUBSTITUTIONS

A. Conditions: Contractor's request for substitution will be received and considered when extensive revisions to the Contract Documents are not required, and changes are in keeping with the general intent of the Contract Documents, when timely, fully documented

PRODUCT REQUIREMENTS 01600-1

and properly submitted; and when one or more of following conditions is satisfied, all as judged by the Owner's representative. Otherwise, requests will be returned without action except to record non-compliance with the requirements.

#### 1.6 PRODUCT SUBSTITUTION PROCEDURES

- A. Submit each Request for Substitution on a "Contractor's Substitution Request" form with complete data substantiating compliance of the proposed substitution with the Contract Documents.
- B. A request constitutes a representation that the Contractor:
  - 1. Has investigated the proposed product and determined that it meets or exceeds the quality level of the specified product.
  - 2. Will provide the same warranty for the substitution as for the specified product.
  - 3. Will coordinate the installation and make changes to other work which may be required for the work to be completed at no additional cost to the Owner.
  - 4. Waives claims for additional cost and time extension which may subsequently become apparent.
- C. Substitutions will not be considered when they are indicated or implied on the Shop Drawing or product data submittals, without a separate written request, or when acceptance will require revision of the Contract Documents.
- D. Substitution Submittal Procedure:
  - 1. Submit four (4) copies of the "Contractor's Substitution Request" form for substitution consideration. Limit each request to one (1) proposed substitution.
  - 2. Submit Shop Drawings, product data, and certified test results attesting to the proposed product's equivalence. The burden of proof lies with the proposer.
  - 3. The Architect will notify the Contractor, in writing, of the decision to accept or reject the substitution request.

#### 1.6A Requests for Substitutions:

- 1. Provide a written substitution request, fully documented to show compliance with the requirements for substitutions. Include product data / drawings, description of methods and samples where applicable. The Contractor shall submit a comparison of significant qualities between the specified item and the proposed substitution, including life expectancy, weatherability, durability, fire resistance, compatibility with other materials, susceptibility to defects due to characteristics unique to the product, and product limitations, including other characteristics such as slip resistance, acoustical properties, etc. The Contractor shall submit a statement of effect on construction time, coordination with other affected work, and the Contractor's statement to the effect that the proposed substitution is satisfactory for use in the Project and will result in overall work equal-to-or-better-than the work originally indicated.
- 2. When not equal-to-or-better, the Contractor shall submit a justification and deductive cost proposal resulting from the substitution.

PRODUCT REQUIREMENTS 01600-3

#### 1.7 PRODUCT DELIVERY REQUIREMENTS

- A. Transport and handle products in accordance with the manufacturer's instructions, using means and methods to prevent damage, deterioration, and loss, including theft.
- B. Schedule product delivery to minimize long-term storage at the Project Site, and to prevent overcrowding of construction spaces.
- C. Coordinate product delivery with the installation schedule to assure minimum holding time for items that are flammable, hazardous, easily damaged, or sensitive to deterioration, theft, and other losses.
- D. Deliver products to the Project Site in undamaged condition, in the manufacturer's original, new, sealed container(s) or packaging system, complete with labels intact and instructions for handling, storing, unpacking, protecting, and installing.
- E. Promptly inspect shipments to ensure that the products comply with the Project requirements, that quantities are correct, products are undamaged, and are properly protected.

#### 1.8 PRODUCT HANDLING AND STORAGE REQUIREMENTS

- A. Store and protect products in accordance with the manufacturers' published instructions, with seals and labels intact and legible.
- B. Store products subject to deterioration above ground, under cover, in a weathertight enclosure and with ventilation adequate to prevent condensation and potential degradation. Maintain temperature and humidity within the range required by the manufacturer's published instructions.
- C. For exterior storage of fabricated products, place on sloped supports, above ground.
- D. Provide off-site storage and protection when the Project Site does not permit on-site storage or proper protection.
- E. Store loose granular materials on solid flat surfaces in a well drained area. Prevent mixing with foreign matter.
- F. Provide equipment and personnel to handle and store products by methods to prevent soiling, disfigurement, and damage.
- G. Arrange storage of products to permit access for inspection. Periodically inspect to verify that the products are undamaged and are maintained in an acceptable condition.

#### 1.9 WARRANTIES

- A. Comply with the Warranty provisions of Section 01012 - Supplementary Conditions.
- B. Categories of Specific Warranties: Warranties on the work are in several categories, including those of the General Conditions, and including, but not necessarily limited to, Sections of Divisions 2 through 16 of these Specifications.

PRODUCT REQUIREMENTS 01600-4

C. Special Project Warranty (Guarantee): A Warranty specifically written and signed by the Contractor for a defined portion of the work; and, where required, countersigned by the subcontractor, installer, manufacturer or other entity engaged by the Contractor.

PART 2 PRODUCTS

Not Used.

PART 3 EXECUTION

Not Used.

END OF SECTION

D. Specified Product Warranty: A Warranty which is required by the Contract Documents, to be provided for a manufactured product incorporated into the work.

E. Coincidental Product Warranty: A Warranty which is not specifically required by the Contract Documents, other than as specified in this Section, but which is available on a product incorporated into the work, by virtue of the fact that the manufacturer has published a Warranty in connection with purchase and use of the product without regards to specific applications.

F. General Limitations: It is recognized that specific Warranties are intended primarily to protect the Owner against failure of the work to perform as required, and against deficient, defective and faulty materials and workmanship, regardless of the source. Except as otherwise indicated, specific Warranties do not cover failures in the work which result from:

1. Unusual and abnormal phenomena of the elements,
2. The Owner's misuse, maltreatment or improper maintenance of the work,
3. Vandalism after the date of Substantial Completion, or
4. Insurrection or acts of aggression, including war.

G. Start Date: Warranties will commence on the date of Substantial Completion of the Project unless otherwise agreed to by the Owner's representative.

H. Reinstatement of Warranty Period: Except as otherwise indicated, when work covered by a special Project Warranty or product Warranty has failed and has been corrected by replacement or restoration, reinstate the Warranty by written endorsement for the original time period, starting on the date of acceptance of the replaced or restored work.

I. Replacement Cost, Obligations: Except as otherwise indicated, the cost of replacing or restoring failing warranted units or products is the Contractor's obligation, without regard for whether or not the Owner has already benefitted from use through a portion of the anticipated useful service life.

J. Related Damages and Losses: In connection with the Contractor's correction of warranted work which has failed, remove and replace other work of the Project which has been damaged as a result of the failure, or must be removed and replaced to provide access for correction of the warranted work.

K. Rejection of Warranties: The Owner reserves the right, at the time of Substantial Completion or thereafter, to reject coincidental product Warranties submitted by the Contractor, which in the opinion of the Owner tend to detract from or confuse interpretation of the requirements of the Contract Documents.

L. Contractor's Procurement Obligations: Do not purchase, subcontract for, or allow others to purchase or sub-subcontract for materials or units of work for the Project where a special Project Warranty, specified product Warranty, certification or similar commitment is required, until it has been determined that the entities required to countersign such commitment are willing to do so.

M. Submittal of Warranty Forms: Where a special Project Warranty (Guarantee) or specified product Warranty is required, prepare a written document to contain terms and appropriate

PRODUCT REQUIREMENTS 01600-5

PRODUCT REQUIREMENTS

01600-6

SECTION 01700  
EXECUTION REQUIREMENTS

- E. Examine and verify specific conditions described in the individual Specifications Sections.
- F. Verify that utility services are available, of the correct characteristics, and in the correct location for the installation of work.

1.3 PREPARATION

- A. Construction Layout:
  - 1. Be responsible for the accuracy of measurements, elevations, lines, and grades of the work.
  - 2. Do not scale Drawings. Use the dimensions indicated on the Drawings for the laying out of work.
  - 3. Errors in construction caused by the Contractor scaling Drawings to obtain measurements for laying out the work is the responsibility of the Contractor. By scaling Drawings, the Contractor assumes responsibility for the performance of such work, and is responsible for the cost of corrective work.
  - 4. Perform field work necessary to lay out and maintain work to the dimensions indicated in the Contract Documents.

1.2 EXAMINATION

- A. Visit the Project Site to determine the existing conditions.
  - 1. Take field measurements and verify field conditions, compare field measurements, conditions, locations of survey benchmarks, and other information known to the Contractor, with the Construction Documents before starting the work.
  - 2. Be responsible for determining conditions of the Project Site, including all existing improvements, paving, above and below ground utilities, and existing construction.
  - 3. Contact local utility companies and agencies and make arrangements to obtain utility locations and marking service before the start of work.
- B. Review Bidding and Contract Documents.
  - 1. Carefully study and compare the Contract Documents with each other.
  - 2. Be responsible for thorough knowledge of the Contract Documents and their relationship to each other.
  - 3. If the Contractor performs work knowing it involves a recognized error, inconsistency, or omission in the Contract Documents, without notice to the Owner's representative, the Contractor assumes responsibility for performance of the work, and is responsible for the cost of corrective work.
- C. Verify that existing conditions and substrate surfaces are acceptable and meet the manufacturer's requirements for the application or installation of work.
- D. Verify that the substrate is capable of structurally supporting attachment of the work being applied or installed.

EXECUTION REQUIREMENTS 01700-1

EXECUTION REQUIREMENTS 01700-2

5. Apply manufacturer's required or recommended substrate primer, sealer, or conditioner before applying products in contact or bond.
- 1.4 EXECUTION
- A. Cutting and Patching:
1. Employ skilled and experienced tradesmen to perform cutting and patching work.
  2. Submit a written request, in advance of cutting or altering elements which affect:
    - a. Structural integrity of an element.
    - b. Integrity of weather-exposed or moisture-resistant elements.
    - c. Efficiency, maintenance, or safety of an element.
    - d. Visual quality of sight exposed elements.
  3. Execute cutting, fitting, and patching to complete work, and to:
    - a. Fit several parts together, to integrate with other work.
    - b. Uncover work to install or correct ill-timed work.
    - c. Remove and replace defective and non-conforming work.
    - d. Remove samples of installed work for testing.
    - e. Provide openings in elements of the work for penetrations of mechanical and electrical work.
  4. Execute work by methods that will avoid damage to other work, and will provide proper surfaces to receive patching and finishing.
  5. Cut masonry and concrete materials using a masonry saw or core drill.
  6. Restore work with new products in accordance with requirements of the Contract Documents.
  7. Fit work tight to pipes, sleeves, ducts, conduit, and other penetrations.
  8. Maintain the integrity of wall, ceiling, and floor construction; completely seal voids.
  9. Refinish surfaces to match adjacent finishes. For continuous surfaces, refinish to the nearest intersection; for an assembly, refinish the entire unit.
  10. Identify any hazardous substance or condition exposed during the work to the Owner's representative for a decision or remedy.
- B. Installation:
1. Refer to the installation requirements in individual Specifications Sections.
  2. For each product, inspect the substrate and conditions under which the work will be performed. Do not proceed with the work until the unsatisfactory conditions

EXECUTION REQUIREMENTS 01700-3

- have been corrected.
3. Comply with manufacturer's published installation instructions and recommendations, to the extent that instructions and recommendations are more explicit or stringent than requirements in the Contract Documents.
  4. Inspect products ready for installation immediately upon delivery to the Project Site.
    - a. Inspect products immediately before the start of application, installation, or erection.
    - b. Reject damaged and defective products.
  5. Verify and check dimensions and measurements before the start of application, installation or erection.
  6. Coordinate the closing-in of work with required inspections and tests.
    - a. Do not cover work until inspected and approved by the appropriate person or entity.
    - b. Uncover work that has not been inspected as directed by the Owner's representative.
  7. Provide fasteners, attachments, connection devices, and methods as indicated on the Drawings, or as specified.
    - a. Where not indicated or specified, provide a appropriate methods necessary for securing the work.
    - b. Secure work plumb, level and true to line.
    - c. Provide for expansion and building movement.
- 1.5 CLEANING
- A. Cleaning During Construction: Coordinate with Section 01500 - Temporary Facilities and Controls.
- PART 2 PRODUCTS  
Not Used.
- PART 3 EXECUTION  
Not Used.

END OF SECTION

EXECUTION REQUIREMENTS 01700-4

SECTION 01705  
PROJECT CLOSEOUT

PART 1 GENERAL

1.1 SUMMARY

A. Section Includes:

1. Description of requirements.
2. Prerequisites for Substantial Completion.
3. Closeout procedures.
4. Final cleaning.
5. Starting and adjusting.
6. Operation and maintenance instructions.
7. Partial occupancy or use.
8. Prerequisites for final acceptance.
9. Default.

B. Related Documents: The Contract Documents, as defined in Section 01010 - Summary of Work, apply to the work of this Section. Additional requirements and information necessary to complete the work of this Section may be found in other Documents.

1.2 DESCRIPTION OF REQUIREMENTS

A. Definitions: Closeout is hereby defined to include the general requirements near the end of the Contract Time in preparation for substantial completion, beneficial occupancy, final acceptance, and final payment.

1.3 PREREQUISITES TO SUBSTANTIAL COMPLETION

A. General: Prior to requesting an Owner representative's inspection for certification of substantial completion (for either the entire work or portions thereof), complete the following:

1. Provide a list of incomplete items, reasons for being incomplete and a schedule for completion.
2. Obtain and submit releases enabling the Owner's full and unrestricted use of the work and access to services and utilities, including recorded Occupancy Permit(s), operating certificates, and similar releases.
3. Make final change-over of locks and transmit keys to the Owner. Advise the Owner's personnel of the change-over in security provisions.
4. Complete start-up and testing of equipment and systems including instruction of

PROJECT CLOSEOUT 01705-1

Owner's operations / maintenance personnel. Discontinue (or change-over) and remove from the Project Site all temporary facilities and services, along with construction tools and facilities, mock-ups, and similar elements.

5. Place in good working order all equipment and systems, including but not limited to, all fire, mechanical, electrical and life safety systems.
6. Submit manuals and other supporting documentation, as indicated in the Contract Documents.
7. Complete final cleaning.

B. Inspection Procedures: Upon receipt of the Contractor's request, the Owner's representative will either proceed with the inspection or advise the Contractor of prerequisites not fulfilled. Following the initial inspection, the Owner's representative will either prepare a Certificate of Substantial Completion, or advise the Contractor of work which must be performed prior to the issuance of a certificate. Repeat the inspection when requested and assured that the work has been substantially completed. Results of completed inspection will form the initial "punch-list" for final acceptance.

1.4 CLOSEOUT PROCEDURES

A. At completion of the work of each subcontract or designated division of the work, conduct an initial inspection to verify completion of the work; prepare a list of work to be completed or corrected, and conduct a follow-up inspection to verify that the corrections have been made.

B. Beneficial Occupancy:

1. When the Contractor considers the work, or a portion of the work which the Owner agrees to accept separately, is substantially complete, submit written certification to the Owner's representative stating that the Contract Documents have been reviewed, work has been inspected, the work is complete in accordance with the Contract Documents, and the work is ready for inspection.

- a. Submit a list of items to be completed or corrected.
- b. Complete and correct items on the list.
- c. Failure to include an item on the list does not change the Contractor's responsibility to complete the work in accordance with the Contract Documents.
- d. Submit Closeout Submittals to the Owner's representative.

2. The Owner's representative will review the list and make an inspection to determine if the work, or designated portion of the work, is substantially complete.

- a. The Contractor will be notified of items identified during inspection as not in accordance with the Contract Documents, whether they were included on the Contractor's list or not.
- b. Contractor to complete and correct items on the list.
- c. Notify the Owner's representative that the items have been corrected and request re-inspection.

PROJECT CLOSEOUT 01705-6



3. The Owner's representative will re-inspect to determine if the work, or designated portion of the work, is substantially complete.
  4. When the work, or designated portion of the work, is substantially complete, the Owner's representative will notify the Contractor and document the Date of Beneficial Occupancy.
- C. Final Acceptance:
1. The Contractor to submit written certification that the Contract Documents have been reviewed, work has been inspected, work is complete in accordance with the Contract Documents, and is ready for final inspection.
  2. The Owner's representative will make an inspection to determine if the work of the Contract is complete.
    - a. The Contractor will be notified by the Owner's representative of items identified during inspection as not in accordance with the Contract Documents, and not ready for final acceptance.
    - b. Contractor to complete and correct items on the list.
    - c. Contractor to notify Owner's representative that items on the list have been corrected and request an inspection.
  3. When the work is complete, as determined by the Owner's representative, the Owner's representative will notify the Contractor and document the Date of Final Acceptance.

1.5 FINAL CLEANING

- A. Complete cleaning operations before requesting inspection for Substantial Completion for Final Acceptance or a portion of the Project.
- B. Provide final cleaning of the work consisting of cleaning each surface or unit of work to a normal "clean" condition expected from a first class building cleaning and maintenance program. Comply with the manufacturer's instructions for cleaning operations.
- C. Use cleaning materials and agents recommended by the manufacturer or fabricator of surfaces to be cleaned. Do not use cleaning agents that are potentially hazardous to health or property, or that might damage finished surfaces.
  1. Remove tools, construction equipment, machinery and surplus materials from the Project Site.
  2. Remove temporary protection devices and facilities installed during construction.
  3. Clean the Project Site, yard and grounds, in areas disturbed by the construction activities, including landscape development areas. Remove rubbish, waste materials, litter and foreign substances. Sweep paved areas broom clean. Remove petrochemical spills, stains and other foreign deposits. Rake grounds that are neither planted nor paved, to a smooth even textured surface.
  4. Remove debris and surface dust from limited access spaces, including roofs, plenums, shafts, trenches, equipment vaults, manholes, attics and similar spaces.
  5. Broom clean concrete floors in unoccupied spaces.

PROJECT CLOSEOUT 01705-3

6. Clean exposed exterior and interior hard-surface finishes to a dirt-free condition, free of stains, films and similar foreign substances. Avoid disturbing the natural weathering of exterior surfaces.
7. Remove labels that are not permanent.
8. Clean transparent materials, including mirrors and glass in doors and windows. Remove glazing compounds and other substances that are noticeable, vision obscuring materials. Replace chipped and broken glass and other damaged transparent materials. Polish mirrors and glass, taking care not to scratch the surfaces.
9. Vacuum clean carpet and similar soft surfaces, remove debris and excess nap; shampoo if required.
10. Touch-up and otherwise repair and restore marred exposed finishes and surfaces. Replace finishes and surfaces that can not be satisfactorily repaired or restored, or that show evidence of repair or restoration. Do not paint over "UL" and similar labels, including mechanical and electrical name plates.
11. Clean plumbing fixtures to a sanitary condition, free of stains, including stains resulting from water exposure. Clean food service equipment to a condition of sanitation ready and acceptable for its intended service use.
12. Clean light fixtures, lamps, globes and reflectors to function with full efficiency. Replace burned out lamps, and defective and noisy starters in fluorescent and mercury vapor fixtures.
13. Replace disposable air filters and clean permanent air filters. Clean exposed surfaces of diffusers, registers, and grills. Clean ducts, blowers, and coils if units were operated without filters during construction.
14. Wipe surfaces of mechanical and electrical equipment clean, including elevator and similar equipment. Remove excess lubricants, paint, mortar droppings and other foreign substances.
15. Leave the entire Project Site clean and ready for occupancy.
  - D. Engage an experienced licensed exterminator to make a final inspection, and rid the Project Site of rodents, insects, and other pests. Comply with regulations of the local authorities having jurisdiction.
  - E. Comply with governing regulations and safety standards for cleaning operations. Remove waste materials from the Project Site and dispose at a designated site, and in accordance with requirements of the local authorities having jurisdiction.

1.6 STARTING AND ADJUSTING

- A. Inspect mechanical and electrical equipment start-up operations, observe testing and balancing, and record the start-up results, including the time and date of start-up.
- B. Starting Systems:
  1. Coordinate the schedule for start-up of the various items of equipment and systems.

PROJECT CLOSEOUT 01705-4

2. Verify that each piece of equipment or system has been checked for proper lubrication, drive rotation, belt tension, control sequence, and for any conditions which may cause damage upon start-up.
3. Verify that tests, meter readings, and the specified electrical characteristics agree with those required by the equipment or system manufacturer.
4. Verify that wiring and support components for equipment are complete and have been tested.
5. Execute start-up under the supervision of appropriate Contractor's personnel, and in accordance with the manufacturers' instructions.

#### 1.7 OPERATION AND MAINTENANCE INSTRUCTIONS

- A. Arrange for each installer of work requiring continuing maintenance or operation to meet with the Owner's personnel at the Project Site to provide basic instructions for proper operation and maintenance of the entire work. Utilize the Operations and Maintenance Manuals as the basis for instructions. Review contents of the manuals, in detail, to explain all aspects of operation and maintenance. Include instructions by manufacturer's representatives where the installers are not expert in the required procedures.
- B. Review maintenance manuals, record documentation, tools, spare parts and materials, lubricants, fuels, identification system, control sequences, shutdown, hazards, trouble-shooting, cleaning, servicing, maintenance and similar procedures.
- C. For operational equipment, demonstrate start-up, shut-down, operation, control, emergency operations, noise and vibration adjustments, safety, economy / efficiency adjustments, energy effectiveness, and similar operations.
- D. Review operations and maintenance in relation to applicable warranties, agreements to maintain, bonds, and similar continuing commitments.
- E. Prepare and insert additional data in the Operations and Maintenance Manuals when need, for data that becomes apparent during the instructions.

#### 1.8 PARTIAL OCCUPANCY OR USE

- A. The Owner shall have the right to occupy or permit its employees, agents, representatives, or subcontractors to occupy any part or parts of the Project (to the extent that such work is not covered hereunder) and to install special items, fixtures, furniture, appliances and equipment, notwithstanding that all work hereunder shall not have been completed at the time of such occupancy, provided, however, that:
  1. The work completed in the part or parts to be occupied shall have been conditionally accepted by the Owner, in writing, specifying any claimed deficiencies in the work completed;
  2. The Owner assumes liability for utilities and the risk of loss with respect to the portion of the Project subject to such early occupancy; and
  3. Any such early occupancy shall not reasonably interfere with the Contractor's sequence for completing its work in the areas occupied or in other areas. The Contractor agrees to fully cooperate and coordinate its effort with such early

PROJECT CLOSEOUT

01705-5

"occupancy" of the Project under this paragraph, and shall give to the Owner prompt notice of any inconvenience, damage, or delay likely to arise from such early occupancy. Such early occupancy shall have no bearing on the commencement of warranty periods.

#### 1.9 PREREQUISITES FOR FINAL ACCEPTANCE

- A. Prior to requesting final inspection for certification of final acceptance and final payment, as required by the General Conditions, complete the following and list known exceptions in the request:
  1. Submit final payment request with final releases and supporting documentation not previously submitted and accepted.
  2. Submit a dated final statement accounting for changes to the Contract Sum.
  3. Submit a certified copy of the final Punch List of itemized work to be completed or corrected, stating that each item has been completed or otherwise resolved for acceptance, endorsed and dated by the Owner's representative.
  4. Submit final meter readings for temporary utilities per Specifications Section 01500 - Temporary Facilities; a measured record of stored fuel, and similar data as of the time of Substantial Completion or when the Owner took possession of and responsibility for corresponding elements of the work.
    5. Submit a consent of Surety to the release of final payment.
    6. Deliver tools, spare parts, extra stocks of materials, and similar physical items to the Owner.
    7. Submit Record Drawings, Record Product Data and Miscellaneous Record Submittals.
    8. Submit Warranties, workmanship / maintenance bonds, maintenance agreements, final certifications and similar documents.
    9. Submit compliance with mechanics liens laws.
- B. Re-inspection Procedure: Upon receipt of the Contractor's notice that the work has been completed, including Punch List items resulting from earlier inspections, and excepting incomplete items delayed because of acceptable circumstances, the Owner's representative will re-inspect the work. Upon completion of the re-inspection, the Owner's representative will either process final closeout documents or advise the Contractor of work not completed or obligations not fulfilled, as required for final acceptance.
- C. Final Payment, Liens and Punch List of Work: If at the time of Final Payment, any application or applications for mechanic's or materialmen's liens have been filed against the Project, the Owner may withhold an amount equal to two hundred percent (200%) of the amount of the claimed lien or liens until the liens are removed or the Contractor posts a bond or cash deposit discharging such liens. The Owner may also withhold from the final payment such amount as the Owner reasonably deems necessary to cover: 1) minor corrective work (Punch List items) until such corrective work has been completed by the Contractor, and 2) any remaining work the Contractor is required to perform under the Contract Documents. The amount withheld shall be two hundred percent (200%) of the value of the incomplete work as reasonably estimated by the Owner.

PROJECT CLOSEOUT

01705-6

1.10 DEFAULT

A. The Owner may declare the Contractor in default in accordance with and in the manner described in the General Conditions of the Contract for Construction for any of the following reasons:

1. Failure to complete the work within the Contract period or any extension thereof.
2. Failure or refusal to comply with an order of the Owner or Architect within a reasonable time.
3. Failure or refusal to remove rejected materials.
4. Failure or refusal to perform anew any defective or unacceptable work.
5. Bankruptcy or insolvency, or the making of an assignment for the benefit of creditors.
6. Failure to pay subcontractors and suppliers promptly.
7. Repeated failure to provide a qualified superintendent, competent workmen or subcontractors to carry out the work in an acceptable manner, or failure to prosecute the work according to the agreed schedule for completion.

PART 2 PRODUCTS

Not Used

PART 3 EXECUTION

Not Used

END OF SECTION

SECTION 01780

CLOSEOUT SUBMITTALS

PART 1 GENERAL

1.1 SUMMARY

A. Section Includes:

1. Maintenance contracts.
  2. Operation and maintenance data.
  3. Product warranties.
  4. Project record documents.
  5. Extra materials.
- B. Related Documents: The Contract Documents, as defined in Section 01010 - Summary of Work, apply to the work of this Section. Additional requirements and information necessary to complete the work of this Section may be found in other Documents.

1.2 MAINTENANCE CONTRACTS

- A. Provide Plant Maintenance as part of the work of this Contract as specified in Section 02930 - Exterior Plants.
- B. Provide Elevator Maintenance as part of the work of this Contract as specified in Section 14240 - Hydraulic Elevators.

1.3 OPERATION AND MAINTENANCE DATA

- A. Prepare instructions and data by personnel experienced in operation and maintenance of the described products and equipment.
- B. Format:
  1. Prepare data in the form of an instructional manual.
  2. Binders: Commercial quality, 8-1/2" x 11", three D, side ring binders with durable plastic covers; 2" maximum ring size. When multiple binders are used, correlate the data into related, consistent groupings.
  3. Cover: Identify each binder with typed or printed title OPERATION AND MAINTENANCE INSTRUCTIONS; identify the title of the Project; identify the subject matter of the contents.
  4. Provide tabbed dividers for each separate product and system, with a typed description of the product and major component parts of equipment.
  5. Text: Manufacturer's published data, or typewritten data on 20 pound paper.

PROJECT CLOSEOUT

01705-7

CLOSEOUT SUBMITTALS

01780-1

6. Drawings: Provide with reinforced punched binder tabs. Bind in with text; fold large drawings to the size of the text pages.
7. Contents: Prepare a Table of Contents for each volume, with each product or system description identified, in three parts as follows:
  - a. Part 1: Directory, listing the name, address, and telephone number of the Architect, Engineers, Contractor, subcontractor, and major equipment suppliers.
  - b. Part 2: Operations and maintenance instructions, arranged by system and subdivided by Specifications Section. For each category, identify the name, address, and telephone number of the subcontractor and suppliers. Identify the following:
    - 1) Significant design criteria.
    - 2) List of equipment.
    - 3) Parts list for each component.
    - 4) Operating instructions.
    - 5) Maintenance instructions for equipment and systems.
    - 6) Maintenance instructions for special finishes, including recommended cleaning methods and materials, and special precautions identifying detrimental agents.
  - c. Part 3: Project documents and certificates, including the following:
    - 1) Shop Drawings and product data.
    - 2) Air and water balance reports.
    - 3) Certificates.
    - 4) Copies of Warranties.

C. Contents, Each Volume:

1. Table of Contents: Provide the title of the Project; name, address, and telephone number of the Architect, Engineer, subcontractor, and the Contractor with the name of the responsible party, schedule of products and systems, indexed to the content of the volume.
2. For Each Product or System: List the name, address and telephone number of subcontractor and suppliers, including the local source of supplies and replacement parts.
3. Product Data: Mark each sheet to clearly identify the specific products and component parts, and data applicable to the installation. Delete or do not include inapplicable information.

CLOSEOUT SUBMITTALS

01760-2

4. Drawings: Supplement product data to illustrate the relationship of component parts of equipment and systems, to show control and flow diagrams. Do not use the Project Record Documents as maintenance drawings.
  5. Typed Text: As required to supplement product data. Provide a logical sequence of instructions for each procedure, incorporating the manufacturer's instructions.
  6. Warranties: Bind in a copy of each.
  7. Lien Release: Include a copy from each subcontractor and major supplier.
- D. Manual for Materials and Finishes:
1. Building Products, Applied Materials, and Finishes: Include product data, with catalog numbers, sizes, composition, and color and texture designations. Provide information for re-ordering custom manufactured products.
  2. Instructions for Care and Maintenance: Include the manufacturer's recommendations for cleaning agents and methods, precautions against detrimental agents and methods, and recommended schedule for cleaning and maintenance.
  3. Moisture Protection and Weather Exposed Products: Include product data listing applicable reference standards, chemical composition, and details of installation. Provide recommendations for inspections, maintenance, and repair.
  4. Additional Requirements: As specified in the individual product Specifications Sections.
  5. Provide a listing in the Table of Contents for design data, with a tabbed fly sheet and space for insertion of data.
- E. Manual for Equipment and Systems:
1. Each Item of Equipment and Each System: Include description of the unit or system, and component parts. Identify function, normal operating characteristics, and limiting conditions. Include performance curves, with engineering data and tests, and complete nomenclature and model number of replaceable parts.
  2. Panelboard Circuit Directories: Provide electrical service characteristics, controls, and communications; typed.
  3. Include color coded wiring diagrams, as installed.
  4. Operating Procedures: Include start-up, break-in, and routine normal operating instructions and sequences. Include regulation, control, stopping, shut-down, and emergency instructions. Include any special operating instructions.
  5. Maintenance Requirements: Include routine procedures and guide for preventative maintenance and trouble shooting; disassembly, repair, and reassembly instructions; and alignment, adjusting, balancing, and checking instructions.
  6. Provide a servicing and lubrication schedule, and a list of lubricants required.

CLOSEOUT SUBMITTALS

01760-3

7. Include the manufacturer's published operation and maintenance instructions.
8. Include sequence of operation by the controls manufacturer.
9. Provide the original manufacturer's parts list, illustrations, assembly drawings, and diagrams required for maintenance.
10. Provide control diagrams by the controls manufacturer, as installed.
11. Provide the Contractor's coordination drawings, with color coded piping diagrams, as installed.
12. Provide charts of valve tag numbers, with the location and function of each valve, keyed to flow and control diagrams.
13. Provide a list of the original manufacturer's spare parts, current prices, and recommended quantities to be maintained in storage.
14. Include test and balancing reports, as specified.
15. Additional Requirements: As specified in the individual product Specifications Sections.
16. Provide a listing in the Table of Contents of design data, with tabbed dividers and space for insertion of additional data.

#### 1.4 PRODUCT WARRANTIES

- A. Submit Warranties required for specific products or work, as specified in the individual Specifications Sections.
- B. Form of Submittals:
  1. Bind in commercial quality 8-1/2" x 11" three D, side ring binders with durable plastic covers.
  2. Cover: Identify each binder with the typed or printed title WARRANTIES with the title of the Project, name, address and telephone number of the Contractor and equipment supplier, and the name of the responsible company principal.
  3. Table of Contents: Neatly typed, in the sequence of the Project Manual, Table of Contents, with each item identified with a number and title of the Specifications Section in which specified, and the name of the product or work item.
  4. Separate each Warranty with index tab sheets keyed to the Table of Contents listing. Provide full information, using separate typed sheets, as necessary. List the subcontractor, supplier, and manufacturer, with the name, address, and telephone number of the responsible principal.
- C. Preparation of Submittals:
  1. Obtain Warranties executed in duplicate by the responsible subcontractor, supplier, and manufacturer, within ten (10) days after completion of the applicable item of work. Except for items put into use with the Owner representative's approval, leave the date of the beginning of the warranty time until the Date of Final Acceptance has been determined.

CLOSEOUT SUBMITTALS 01760-4

2. Verify that the documents are in the proper form, contain complete information, and are notarized.
  3. Co-execute submittals when required.
  4. Retain Warranties until the time specified for submittal.
- D. Time of Submittals:
1. For equipment or component parts of equipment put into service during construction with the Owner representative's approval, submit documents within ten (10) days after acceptance.
  2. Make other submittals within ten (10) days after the Date of Substantial Completion, and prior to the final Application for Payment.
  3. For items of work for which acceptance is delayed beyond the Date of Substantial Completion, submit within ten (10) days after acceptance.

#### 1.5 PROJECT RECORD DOCUMENTS

- A. Project Record Documents required include:
  1. As-Built copies of the Contract Drawings.
  2. Marked-up copies of the Shop Drawings.
  3. Marked-up copies of the Specifications, addenda and Contract Modifications.
  4. Marked-up product data submittals.
  5. Field records for variable and concealed conditions.
  6. Record information on work that is recorded only schematically.
- B. Specific record copy requirements that expand the requirements of this Section are included in the individual Specifications Sections of Division 2 through Division 16.
- C. Maintenance of Documents: Store the Record Documents in a field office apart from the Contract Documents used for construction. Do not permit the Project Record Documents to be used for construction purposes. Maintain and protect the Record Documents from damage in a clean, dry, legible condition. Make Documents available at all times for inspection by the Owner's representative.
- D. Record (As-Built) Drawings:
  1. During construction, maintain a set of blackline, white prints of the Contract Drawings and Shop Drawings for Project Record Document purposes.
    - a. Mark these Drawings to indicate actual installations where the installations vary from the installation originally shown. Give particular attention to information on concealed elements which would be difficult to identify or measure and record later. Items required to be marked include but are not limited to:

CLOSEOUT SUBMITTALS 01760-5

- 1) Dimensional changes to the Drawings.
  - 2) Revisions to Details shown on the Drawings.
  - 3) Depth of foundations below the first floor.
  - 4) Locations and depths of underground utilities.
  - 5) Revisions to the routing of piping and conduits.
  - 6) Revisions to electrical circuitry.
  - 7) Actual equipment locations.
  - 8) Duct sizes and routing.
  - 9) Locations of concealed internal utilities.
  - 10) Changes made by Contract Modifications.
  - 11) Details not on the original Contract Drawings.
- b. Mark completely and accurately record on prints of the Contract Drawings or Shop Drawings, whichever is most capable of showing the actual physical conditions. Where Shop Drawings are marked, show a cross-reference on the Contract Drawings.
  - c. Mark important additional information which was either shown schematically or omitted from the original Drawings.
  - d. Note construction change directive numbers, alternate numbers, Change Order numbers, clarification numbers and similar identification.
  - e. Responsibility for Markup and Supervision: Contractor Quality Control Representative, as specified in Section 01450 - Quality Control. Where feasible, the name of the individual or entity who obtained the record data, whether individual or entity is installer, subcontractor, or similar entity, is required to prepare mark-ups on the Record Drawings.
    - 1) Accurately record information in an understandable Drawing technique.
    - 2) Record data as soon as possible after it has been obtained. In case of concealed installations, record and check mark-ups prior to concealment.
    - 3) Contractor Quality Control Representative: Affix signature and certify accuracy of the Record Drawings.
2. Preparation of As-Built Drawings: Immediately prior to the inspection for Final Acceptance, review the completed marked-up record Drawings with the Owner's representative. Prepare a full set of corrected Drawings of as-built conditions.
    - a. Incorporate changes and additional information previously marked on the print sets. Erase, redraw, and add details and notations where applicable. Identify and date each Drawing; include the printed

CLOSEOUT SUBMITTALS

01760-6

- designation "PROJECT AS-BUILT DRAWINGS" in a prominent location on each Drawing.
- b. Refer instances of uncertainty to the Owner's representative for resolution.
  - c. The Owner's representative will make the original Contract Drawings available to the Contractor in electronic format.
  - d. The Contractor is responsible for printing the original Contract Drawings and other Drawings.
  - e. Review of Drawings: Before copying and distributing, submit corrected Drawings and the original marked-up prints to the Owner's representative for review.
3. Copies and Distribution: After completing the preparation of As-Built Drawings, submit two (2) complete sets of the Drawings on reproducible vellum sheets (24" x 36"), and two (2) complete zip disks (100 mb AutoCAD). Place each set of Drawings in durable tube-type containers with end caps. Mark the end cap of each container with suitable identification. Mark the zip disks similarly.
    - a. Organize and bind the original marked-up set of prints that were maintained during construction in the same manner.

E. Record Specifications:

1. During the construction period, maintain one copy of the Project Specifications, including addenda and any modifications issued, for Project Record Document purposes.
  - a. Mark the Specifications to indicate actual installations where the installation varies from that indicated in the Specifications and modifications issued. Note related Project Record Drawing information, where applicable. Give particular attention to substitutions, selection of product options, and information on concealed installations that would be difficult to identify or measure and record later.
    - 1) In each Specifications Section where products, materials or units of equipment are specified or scheduled, mark the copy with the proprietary name and model number of the product furnished.
    - 2) Record the name of the manufacturer, supplier and installer, and other information necessary to provide a record of the selections made and to document coordination with the Record Product Data submittals and Maintenance Manuals.
    - 3) Note the related Record Product Data, where applicable. For each principal product specified, indicate whether the Record Product Data has been submitted in a Maintenance Manual instead of submitted as Record Product Data.
3. Upon completion of the mark-up, submit Record Specifications to the Owner's representative.
  - F. Record Product Data:

CLOSEOUT SUBMITTALS

01760-7

1. During construction, maintain one (1) copy of each Product Data submittal for Project Record Document purposes.
  - a. Mark the Product Data to indicate the actual product installation where the installation varies from that indicated in the Product Data submitted. Include significant changes in the product delivered to the Project Site, and changes in the manufacturer's instructions and recommendations for installation.
  - b. Give particular attention to information on concealed products and installations that cannot be readily identified and recorded later.
  - c. Note related Contract Modifications and mark-up of Record Drawings, where applicable.
  - d. Upon completion of the mark-up, submit a complete set of the Record Product Data to the Owner's representative with an index of all product data cross-referenced to submittal numbers.
  - e. Where the Record Product Data is required as part of the Maintenance Manuals, submit the marked-up Product Data as an insert in the Manual instead of submittal as Record Product Data.

- 12) Documented qualifications of installation firms.
- 13) Load and performance testing.
- 14) Inspections and certifications by governing authorities.
- 15) Leakage and water-penetration tests.
- 16) Fire resistance and flame spread test results.
- 17) Final inspection and correction procedures.

1.6 EXTRA MATERIALS

- A. Provide products, spare parts, maintenance, and extra materials in the quantities specified in the individual Specifications Sections.
- B. Deliver to the Project Site and place in a location directed by the Owner's representative; obtain a receipt prior to final payment.

PART 2 PRODUCTS

Not Used.

PART 3 EXECUTION

Not Used.

END OF SECTION

G. Additional Record Submittals:

1. Refer to other Specifications Sections for miscellaneous record-keeping requirements and submittals in connection with various construction activities. Immediately prior to Final Acceptance, complete additional records and place in order, properly identified and bound or filed, ready for use and reference. Submit to the Owner's representative.
  - a. Categories of requirements resulting in miscellaneous records include, but are not limited to the following:
    - 1) Field records of excavations and foundations.
    - 2) Field records of underground construction and similar work.
    - 3) Survey showing locations and elevations of underground lines.
    - 4) Invert elevations of drainage piping.
    - 5) Surveys establishing building lines and levels.
    - 6) Authorized measurements utilizing unit prices or allowances.
    - 7) Records of plant treatment.
    - 8) Ambient and substrate condition tests.
    - 9) Certifications received in lieu of labels on bulk products.
    - 10) Batch mixing and bulk delivery records.
    - 11) Testing and qualification of tradesmen.

CLOSEOUT SUBMITTALS

01760-8

CLOSEOUT SUBMITTALS

01760-9

SECTION 02050

DEMOLITION AND REMOVAL

PART 1 - GENERAL

- 1.1 PROCEDURES: Areas in which demolition and removal is to be accomplished shall be as indicated on the drawings either specifically or as a necessary or incidental part of the work. The procedures shall provide for the safe conduct of the work, careful removal and disposition of materials to be removed, protection of property, which is to remain undisturbed, and coordination with other work involved.
- 1.2 Do not begin demolition until authorization is received from the Engineer. Remove rubbish and debris from the project site daily; do not allow accumulations inside or outside the buildings. Store materials that cannot be removed daily in areas designated by the Engineer.
- 1.3 The Contractor shall submit his/her demolition and removal procedures to the Engineer for approval before work is started. Demolition plan shall include procedures for careful removal and disposition of materials specified to be salvaged, coordination with other work in progress, a disconnection schedule of utility services, and a detailed description of methods and equipment to be used for each and sequence of operation.
- 1.4 EXPLOSIVES: Use of explosives will not be permitted.
- 1.5 PROTECTION OF EXISTING STRUCTURES, UTILITIES AND OTHER ITEMS OF PROPERTIES: Existing structures, utilities, and other items of properties to remain shall be protected from damage during demolition and removal operation. Any damage to existing facilities, structures, utilities or other works shall be repaired by the Contractor, using materials equal to or better than those existing, all at the Contractor's expense.
- 1.6 In addition, the Contractor shall seek and obtain written clearances from all utility agencies of the Government of Guam, specifically DPW, GPA, GTA, GWA, MCV, etc. prior to undertaking demolition/removal operations. As part of obtaining such clearances, the Contractor shall specifically request each utility agency to stake out the location of their utilities prior to undertaking any demolition or removal work.

PART 2 - PRODUCTS (Not Used)

PART 3 - EXECUTION

3.1 DEMOLITION

- A. The work includes the demolition and removal of existing structures, concrete pads, fences, waterlines, and other items as indicated on the drawings or as required to accomplish the work. Miscellaneous items that will be a hindrance or hazardous to the work to be done shall be removed and disposed of as directed by the Engineer.
- B. Dust and Noise Control: The amount of dust resulting from demolition shall be controlled to prevent the spread of dust to occupied portions of the area and to avoid creation of a nuisance in surrounding areas. Use of water will not be permitted when it will result in, or create, hazardous or objectionable conditions such as flooding, or pollution. Noise associated with the demolition shall be controlled by proper selection of the equipment used, procedure selected, time of day, or day of the week the work is accomplished, to minimize adverse effects of the necessary noise on the every-day operations or activities of the Contractor.

DEMOLITION AND REMOVAL

02050-2

C. Notifications: Furnish timely notification of demolition work to the Engineer in writing 10 working days prior to the commencement of demolition work.

D. Traffic Control Plan: Where pedestrian and driver safety is endangered in the area of removal work, use traffic barricades with flashing lights. Notify the Engineer prior to beginning such work.

E. Existing Work: Protect existing work, which is to remain in place, be reused, or remain the property of the Government. Repair items, which are to remain, and which are damaged during the performance of the work to their original or better condition or replace with new. Provide new supports and reinforcements to existing construction weakened by demolition or removal work. Repairs, reinforcements, or structural replacements must have Engineer's approval.

F. Relocations: Perform the removal and reinstallation of relocated items as indicated with the workmen skilled in the trades involved. Coordinate with agency that has jurisdiction over the utility to be relocated. Repair items to be relocated, which are damaged or replace damaged items with new undamaged items as approved by the Engineer.

G. Title to Materials: Except where specified in other Sections, all material and equipment removed, and not reused, shall become the property of the Contractor and shall be removed from the project site. Title to material resulting from demolition, and materials and equipment to be removed, is vested in the Contractor upon approval by the Engineer of the Contractor's demolition and removal procedures, and authorization by the Engineer to begin demolition. The Owner will not be responsible for the condition or loss of, or damage to, such property after contract award. Materials and equipment shall not be viewed by prospective purchasers or sold on the site.

H. Salvage: The Contractor shall remove existing facilities, as necessary or as indicated; salvage usable materials as directed; store, transport, stockpile and/or protect it at the location designated. All salvaged materials shall be the property of the Owner.

I. Disposition: Refuse resulting from demolition operations shall be hauled at the Contractor's expense to an approved disposal site(s) or landfill and shall be disposed of at the Contractor's expense in such a manner as to meet all applicable requirements, regulations and laws of the Government of Guam regarding environmental protection, health, safety and public welfare. The Contractor may not dispose of such refuse by burning on the site of the project at any time.

In no case shall any material be left on the project, shoved onto abutting properties or areas, or be burned in embankments or trenches on the project. Demolition and removal/disposal operations shall be carried out well in advance of construction operations so as to permit a well planned schedule of work.

3.2 CLEANUP: Upon completion of demolition and removal operations, the entire area shall be cleaned of all debris and rubbish in a manner satisfactory to the Engineer.

END OF SECTION

DEMOLITION AND REMOVAL

02050-1



SECTION 02102

CLEARING AND GRUBBING

PART 1 - GENERAL

- 1.1 PROCEDURES: Areas in which clearing and grubbing is to be accomplished shall be as indicated on the drawings either specifically or as a necessary or incidental part of the work. The procedures shall provide for the safe conduct of the work, careful removal and disposition of materials to be removed, protection of property that is to remain undisturbed and coordination with other work involved.
  - 1.2 EXPLOSIVES: Explosives shall not be used for clearing and grubbing work.
  - 1.3 PROTECTION OF EXISTING STRUCTURES, UTILITIES AND OTHER ITEMS OF PROPERTIES: Existing structures, utilities, and other items of properties designated to remain not identified to be removed shall be protected from damage during clearing and grubbing.
- In addition, the Contractor shall seek and obtain written clearances from utility agencies, with existing utilities, structures, and facilities at or near the project site, prior to undertaking any clearing and grubbing operations. Any damage to existing facilities, structures, utilities or other works shall be repaired by the Contractor, using materials equal to or better than those existing, all at the Contractor's expense.

PART 2 - PRODUCTS (Not Used)

PART 3 - EXECUTION

- 3.1 CLEARING: Clearing shall consist of the felling of trees and the satisfactory disposal of surface objects, trees, and other vegetation not designated to remain, including mowing, as required. Trees, stumps, roots, brush, and other vegetation in areas to be cleared shall be cut off six (6) inches below the existing ground surface, except such trees and vegetation as may be indicated or directed to be left standing. Hedges shall be pulled or grubbed in such a manner as to assure complete and permanent removal. Clearing shall also include the removal and disposal of structures that obstruct, encroach upon, or otherwise obstruct the work. Demolition is specified in the Section 02050 entitled "Demolition and Removal".
- 3.2 TREE REMOVAL: Trees not designated by the drawings or by the Engineer to remain shall be removed by cutting to 6 inches below the existing ground without removing stumps, unless otherwise required. The work shall include the felling and disposal of such trees.
- 3.3 GRUBBING: Grubbing shall consist of the removal and disposal of stumps, roots larger than three (3) inches in diameter, and matted roots from the area as affected by the proposed site improvements. This material, together with logs and other organic or non-perishable solid objects shall be excavated and removed to a depth of not less than twelve (12) inches below the original soil surface level of the ground in areas indicated to be grubbed and in areas indicated as construction areas under this contract. Depressions made by grubbing shall be filled with suitable material and compacted to make the surface conform to the original adjacent surface of the ground.
- 3.4 DISPOSAL OF CLEARED AND GRUBBED MATERIALS: All trees, shrub vegetation, and debris shall be removed from the project site and disposed of at an approved location. The Contractor shall make all necessary arrangements with property owners in writing as well as obtain required permits for the use of off-site disposal locations. Woody material may be disposed of by chipping. The wood chips may be used for mulch, slope erosion control or may be uniformly spread over selected areas as directed.

END OF SECTION

EARTHWORKS

02200-

CONCRETE FORMS AND ACCESSORIES 03100-1

SECTION 03100

CONCRETE FORMS AND ACCESSORIES

PART 1 - GENERAL

1.1 REFERENCES

The latest issues of the publications listed below form a part of this specification to the extent referenced. The publications are referred to in the text by the basic designation only.

- A. AMERICAN CONCRETE INSTITUTE (ACI)
  - ACI 301 Structural Concrete for Buildings
  - ACI 347R Formwork for Concrete
- B. AMERICAN HARDBOARD ASSOCIATION (AHA)
  - AHA A135.4 Basic Hardboard
- C. AMERICAN SOCIETY FOR TESTING AND MATERIALS (ASTM)
  - C 39 Compressive Strength of Cylindrical Concrete Specimens
- D. CORPS OF ENGINEERS (COE)
  - COE CRD-C-572 Polyvinylchloride Waterstop
- E. U.S. DEPARTMENT OF COMMERCE PRODUCT STANDARDS (PS)
  - PS-1 Construction and Industrial Plywood

1.2 SUBMITTALS: Submit the following in accordance with Section 01330, "Submittal Procedures."

- A. SD-02 Manufacturer's Catalog Data
  - 1. Waterstops

PART 2 - PRODUCTS

2.1 MATERIALS FOR FORMS

Provide wood, plywood, or steel. Use plywood or steel forms where a smooth form finish is required. Lumber shall be square edged or tongue-and-groove boards, free of raised grain, knotholes, or other surface defects. Plywood: PS-1, B-B concrete form panels or better or AHA A135.4, hardboard for smooth form lining. Steel form surfaces shall not contain irregularities, dents, or sags.

2.2 FORM TIES AND ACCESSORIES

The use of wire alone is prohibited. Form ties and accessories shall not reduce the effective cover of the reinforcement.

- A. Polyvinylchloride Waterstops: COE CRD-C-572.

PART 3 - EXECUTION

3.1 FORMS

ACI 301. Provide forms, shoring, and scaffolding for concrete placement. Set forms mortar-tight and true to line and grade. Chamfer above grade exposed joints, edges, and external corners of concrete 20 mm unless otherwise indicated. Provide formwork with clean-out openings to permit inspection and removal of debris. Forms submerged in water shall be watertight.

A. Coating: Before concrete placement, coat the contact surfaces of forms with a non-staining mineral oil, non-staining form coating compound, or two coats of nitrocellulose lacquer. Do not use mineral oil on forms for surfaces to which adhesive, paint, or other finish material is to be applied.

B. Removal of Forms and Supports: After placing concrete, forms shall remain in place for the time periods specified in ACI 347R. Prevent concrete damage during form removal.

1. Special Requirements for Reduced Time Period: Forms may be removed earlier than specified if ASTM C 39 test results of field-cured samples from a representative portion of the structure indicate that the concrete has reached a minimum of 85 percent of the design strength.

C. Re-shoring: Re-shore concrete elements where forms are removed prior to the specified time period. Do not permit elements to deflect or accept loads during form stripping or re-shoring. Forms on columns, walls, or other load-bearing members may be stripped after 2 days if loads are not applied to the members. After forms are removed, slabs and beams over 3000 mm in span and cantilevers over 1200 mm shall be re-shored for the remainder of the specified time period in accordance with paragraph entitled "Removal of Forms." Perform re-shoring operations to prevent subjecting concrete members to overloads, eccentric loading, or reverse bending. Re-shoring elements shall have the same load-carrying capabilities as original shoring and shall be spaced similar to original shoring. Firmly secure and brace re-shoring elements to provide solid bearing and support.

3.2 WATERSTOP SPLICES

Fusion weld in the field.

3.3 FORMED SURFACES

A. Tolerances: ACI 347R and as indicated.

B. As-Cast Form: Provide form facing material producing a smooth, hard, uniform texture on the concrete. Arrange facing material in an orderly and symmetrical manner and keep seams to a practical minimum. Support forms as necessary to meet required tolerances. Material with raised grain, torn surfaces, worn edges, patches, dents, or other defects which will impair the texture of the concrete surface shall not be used.

END OF SECTION 03100

CONCRETE FORMS AND ACCESSORIES 03100-2

SECTION 03200

CONCRETE REINFORCEMENT

PART 1 - GENERAL

1.1 REFERENCES

The latest issues of the publications listed below form a part of this specification to the extent referenced. The publications are referred to in the text by the basic designation only.

A. AMERICAN SOCIETY FOR TESTING AND MATERIALS (ASTM)

A 82 Steel Wire, Plain, for Concrete Reinforcement

A 185 Steel Welded Wire Fabric, Plain, for Concrete Reinforcement

A 496 Steel Wire, Deformed, for Concrete Reinforcement

A 497 Steel Welded Wire Fabric, Deformed, for Concrete Reinforcement

A 615/A 615M Deformed and Plain Billet-Steel Bars for Concrete Reinforcement

1.2 SUBMITTALS

Submit the following in accordance with Section 01330, "Submittal Procedures."

A. SD-04 Drawings

1. Reinforcing steel: ACI 315. Indicate bending diagrams, assembly diagrams, splicing and laps of bars, shapes, dimensions, and details of bar reinforcing, accessories, and concrete cover. Do not scale dimensions from structural drawings to determine lengths of reinforcing bars.

2. Reproductions of contract drawings are unacceptable.

1.3 DELIVERY, STORAGE, AND HANDLING

Store reinforcement of different sizes and shapes in separate piles or racks raised above the ground to avoid excessive rusting. Protect from contaminants such as grease, oil, and dirt. Ensure bar sizes can be accurately identified after bundles are broken and tags removed.

PART 2 - PRODUCTS

2.1 REINFORCEMENT

A. Reinforcing Bars: ACI 301 unless otherwise specified. ASTM A 615/A 615M 617M with the bars Grade 60.

B. Mechanical Reinforcing Bar Connectors: ACI 301. Provide 125 percent minimum yield strength of the reinforcement bar.

CONCRETE REINFORCEMENT 03200-1

- C. Welded Wire Fabric: ASTM A 185 or ASTM A 497. Provide flat sheets of welded wire fabric for slabs and toppings.
- D. Wire: ASTM A 82 or ASTM A 496.
- E. Reinforcing Bar Supports: Provide bar ties and supports of coated or non-corrodible material.

PART 3 - EXECUTION

3.1 PLACING REINFORCEMENT AND MISCELLANEOUS MATERIALS

- A. ACI 301. Provide bars, wire fabric, wire ties, supports, and other devices necessary to install and secure reinforcement. Reinforcement shall not have rust, scale, oil, grease, clay, or foreign substances that would reduce the bond. Rusting of reinforcement is a basis of rejection if the effective cross-sectional area or the nominal weight per unit length has been reduced. Remove loose rust prior to placing steel. Tack welding is prohibited.
- A. Reinforcement Supports: Place reinforcement and secure with galvanized or non-corrodible chairs, spacers, or metal hangers. For supporting reinforcement on the ground, use concrete or other non-corrodible material, having a compressive strength equal to or greater than the concrete being placed.
- B. Splicing: As indicated. For splices not indicated ACI 301. Do not splice at points of maximum stress. Overlap welded wire fabric the spacing of the cross wires, plus 50 mm.
- C. Future Bonding: Plug exposed, threaded, mechanical reinforcement bar connectors with a greased bolt. Bolt threads shall match the connector. Countersink the connector in the concrete. Calk the depression after the bolt is installed.
- D. Cover: ACI 301 for minimum coverage, unless otherwise indicated.

END OF SECTION 03200

SECTION 03300  
CAST-IN-PLACE CONCRETE

PART 1 - GENERAL

1.1 APPLICABLE PUBLICATIONS

The latest issues of the publications listed below form a part of this specification to the extent referenced. The publications are referred to in the text by the basic designation only.

- A. U.S. Army Corps of Engineers (COE) Waterways Experiment Station Publications:
  - CRD-C-621 Handbook for Concrete and Cement, Specification for Non-shrink Grout
- B. U.S. Department of Commerce Product Standard (PS):
  - PS 1 Construction and Industrial Plywood
- C. American Concrete Institute (ACI) Publications:
  - 211.1 Standard Practice for Selecting Proportions for Normal, Heavyweight, and Mass Concrete
  - 301 Specifications for Structural Concrete for Buildings
  - 302.1R Guide for Concrete Floor and Slab Construction
  - 304 Recommended Practice for Measuring, Mixing, Transporting, and Placing Concrete
  - 305R Hot Weather Concreting
  - 315 Details and Detailing of Concrete Reinforcing
  - 318 Building Code Requirements for Reinforced Concrete
  - 347 Recommended Practice for Concrete Formwork
- D. American Society for Testing and Materials (ASTM) Publications:
  - A82 Steel Wire, Plain for Concrete Reinforcement, Specification for
  - A185 Steel Welded Wire Fabric Plain, for Concrete Reinforcement, Specification for
  - A496 Steel Wire, Deformed, for Concrete Reinforcement Cement, Specification for
  - A497 Steel Welded Wire Fabric Deformed for Concrete Reinforcement, Specification for
  - A615 Deformed and Plain Billet-Steel Bars for Concrete Reinforcement, Specifications for

CONCRETE REINFORCEMENT 03200-2

CAST-IN-PLACE CONCRETE 03300-1

A616	Rail-Steel Deformed and Plain Bars for Concrete Reinforcement, Specifications for	D1.4	Structural Welding Code-Reinforcing Steel
A617	Axle-Steel Deformed and Plain Bars for Concrete Reinforcement, Specifications for	1.2	DESCRIPTION OF WORK The work includes the provision of cast-in-place concrete. In the ACI publications referred to herein, the advisor provisions shall be considered to be mandatory, as though the word "shall" has been substituted for "should" wherever it appears; reference to the "Building Official," the "Structural Engineer," and the "Architect/Engineer," shall be interpreted to mean the Engineer.
A706	Low-Alloy Steel Deformed Bars for Concrete Reinforcement, Specification for	1.3	QUALITY CONTROL The Quality Control provisions of Division 1, Section 01400 apply to this section. All approvals, except those required for field installations, field applications and field tests, shall be before construction is started and before delivery of materials or equipment to the project site.
C31	Practice for Making and Curing Concrete Test Specimens in the Field	1.4	SUBMITTALS
C33	Concrete Aggregates, Specifications for	A.	Shop Drawings: Reproductions of contract drawings are unacceptable.
C39	Compressive Strength of Cylindrical Concrete Specimens, Test Methods for	1.	Shop Drawings for Reinforcing Steel: ACI 315. Indicate bending diagrams, assembly diagrams, splicing and laps of bars, shapes, dimensions and details of bar reinforcing, construction joints, accessories, and concrete covering. Do not scale dimensions from structural or detail drawings to determine lengths of reinforcing rods.
C42	Test Method for Obtaining and Testing Drilled Cores and Sawed Beams of Concrete	2.	Subcontractor Mix Design: Thirty (30) days minimum prior to concrete placement, submit a mix design for each strength and type of concrete. Furnish a complete list of materials including type; brand; source and amount of cement. Obtain approval before concrete placement. Obtain acknowledgment of receipt prior to concrete placement. Submit additional data regarding concrete aggregates if the source of aggregate changes.
C94	Specification for Ready-Mixed Concrete	B.	Certificates of Compliance: Before delivery of materials, certified test reports are required for the following:
C136	Sieve Analysis of Fine and Coarse Aggregates, Test Method for	1.	Aggregates
C143	Slump of Hydraulic Cement Concrete, Test for	2.	Reinforcement
C150	Portland Cement, Specification for	3.	Cement
C171	Sheet Materials for Curing Concrete, Specification for	4.	Admixtures
C172	Sampling Freshly Mixed Concrete, Practice for	C.	Catalog Data:
C173	Air Content of Freshly Mixed Concrete by the Volumetric Method, Test Method for	1.	Materials for Curing Concrete
C231	Air Content of Freshly Mixed Concrete by the Pressure Method, Test Method for	2.	Joint Sealant
C309	Liquid Membrane-Forming Compounds for Curing Concrete, Specification for	3.	Joint Filler
C494	Chemical Admixtures for Concrete, Specification for	4.	Epoxy Grout
C881	Epoxy-Resin-Base Bonding Systems for Concrete, Specification for	1.5	DELIVERY
C920	Elastomeric Joint Sealants, Specification for		
D1190	Concrete Joint Sealer, Hot-Poured Elastic Type, Specification for		
D1751	Preformed Expansion Joint Filler for Concrete Paving and Structural Construction (Non-extruding and Resilient Bituminous Types), Specification for		
D1752	Preformed Sponge Rubber and Cork Expansion Joint Fillers for Concrete Paving and Structural Construction, Specification for		
E.	American Welding Society (AWS) Publication:		
	CAST-IN-PLACE CONCRETE		03300-2
	CAST-IN-PLACE CONCRETE		03300-3

Do not deliver concrete until vapor barrier, forms, reinforcement, embedded items, and chamfer strips are in place and ready for concrete placement.

1.6 STORAGE

ACI 301 for job site storage of concrete aggregates. Store reinforcement of different sizes and shapes in separate piles or racks raised above the ground to avoid excessive rusting. Protect from contaminants such as grease, oil, and dirt. Provide for accurate identification after bundles are broken and tags removed.

PART 2 - PRODUCTS

2.1 CONCRETE

A. Subcontractor-Furnished Mix Design: Concrete shall be designed in accordance with ACI 211.1 and ACI 301. Concrete shall have a 28-day compressive strength of 4,000 psi unless specified otherwise and have a maximum aggregate size of 3/4".

1. Slump Requirements:

Element	Slump, Inches	
	Minimum	Maximum
Walls, columns, and grade beams	2	4
Floors, exterior slabs, and other building Construction	1	3

2.2 CONCRETE MATERIALS

- A. Cement: Cement shall be Type I or II, conforming to ASTM C150 or approved equal.
  - B. Water: Water for mixing and curing including free moisture and water in the aggregates, shall be fresh, clean and potable.
  - C. Water Cement Ratio: Shall not exceed 0.50 for concrete with specified compressive strength of 4000 psi or more.
  - D. Aggregates: In general, aggregates shall be free from deleterious coatings, roots, bark, and other extraneous material. All aggregates shall conform to ASTM C33 and shall be thoroughly and uniformly washed before use.
- Coarse aggregate shall be made from sound, clean coralline limestone in accordance with ASTM C136, conforming to the following gradation requirements:

	1-1/2"	1"	3/4"	1/2"	3/8"	#4	#8	#16
1	100	90-100	---	25-60	---	0-10	0-5	---
3/4		100	90-100	---	20-55	0-10	0-5	---
1/2			100	90-100	40-70	0-15	0-5	---
3/8				100	85-100	0-30	0-10	---

Fine aggregate shall be manufactured from clean coralline limestone in accordance with ASTM C136, conforming to the following grading requirements.

Sieve	Percent Passing
3/8 inch	100
No. 4	95-100
No. 8	80-100
No. 16	50-85
No. 30	25-60
No. 50	10-30
No. 100	2-10

E. Proportioning, Measuring and Mixing:

- 1. Proportioning of Materials: Proportioning of materials shall be accomplished by weighing. Volumetric proportioning may be used subject to approval of the Engineer. The Subcontractor shall furnish the necessary equipment and shall establish accurate procedures, subject to the approval of the Engineer for determining the quantities of free moisture in the aggregates. Allowable tolerances for measuring cement and water shall be 1 percent, and for aggregates 2 percent.
- 2. Mixing: All concrete shall be machine mixed. In emergencies, the mixing may be done by hand if so authorized by the Engineer. Mixing shall begin within 30 minutes after the cement has been added to the aggregates.
- F. Ready-Mixed Concrete: Ready-mixed concrete shall conform to ASTM C94 as modified herein. Ready-mixed concrete is defined in this specification as concrete produced regularly by a commercial establishment and delivered to the purchaser in the plastic state. Cement, aggregates and water shall conform to all applicable requirements of this specification.
- G. Skim Coat Cement Finish: Cement based polymer modified, quick setting concrete finishing material; dry powder blend of Portland cement and acrylic additives designed specifically for application to concrete surfaces for Class A finish. Fine finish texture. BONDEDE PRO-FINISH or LA HABRA ACRYLIC FINISH.

2.3 ADMIXTURES

- A. Accelerating: ASTM C494, Type C.
- B. Retarding: ASTM C494, Type B, D, or G.

CAST-IN-PLACE CONCRETE

03300-4

CENTRAL POLICE PRECINCT

03300-5

- C. Water Reducing: ASTM C494, Type A, E, or F.

2.4 MATERIALS FOR FORMS

Provide wood, plywood, or steel. Use plywood or steel forms where a smooth form finish is required. Lumber shall be square edged or tongue-and-groove board, free of raised grain, knotholes, or other surface defects. Plywood: PS1, B-B concrete form panels or better. Steel form surfaces shall not contain irregularities, dents, or sags.

2.5 REINFORCEMENT

- A. Reinforcing Bars: ACI 301, unless otherwise specified: ASTM A615, Grade 60.
- B. Welded Wire Fabric: ASTM A497 or ASTM A185, 6 by 6, W1.4 by W1.4, unless otherwise indicated.
- C. Mechanical reinforcing Bar Connectors: ACI 301. Provide 125 percent minimum yield strength of the reinforcement bar.
- D. Wire: ASTM A82 or ASTM A496.

2.6 MATERIALS FOR CURING CONCRETE

- A. Impervious Sheetting: ASTM C171; waterproof paper, clear or white polyethylene sheeting, or polyethylene-coated burlap.
- B. Liquid Membrane-Forming Compound: ASTM C309, white-pigmented, Type 2, Class B, free of paraffin or petroleum.

2.7 EXPANSION/CONTRACTION JOINT FILLER

ASTM D1751 or ASTM D1752, 1/2 inch thick, unless otherwise indicated.

2.8 EPOXY GROUT

(For joints between old and new concrete and where called on the drawings) Three-component units composed of 100% solids ASTM-C881 epoxy resin system. Provide material type, grade, and class to suit project requirements.

PART 3 - EXECUTION

3.1 FORMS

ACI 301. Provide forms, shoring, and scaffolding for concrete placement unless indicated or specified otherwise. Concrete for footings may be placed in excavations without forms upon inspection and approval by the Engineer. Excavation width shall be a minimum of 4 inches greater than indicated. Set forms mortar-tight and true to line and grade. Chamfer above grade exposed joints, edges, and external corners of concrete 0.75 inch unless otherwise indicated. Provide forms with clean-out openings to permit inspection and removal of debris. Forms submerged in water shall be watertight.

- A. Coating: Before concrete placement, coat the contact surfaces of forms with a non-staining mineral oil, non-staining form coating compound, or two coats of nitrocellulose lacquer. Do not use mineral oil on forms for surfaces to which adhesive, paint, or other finish material is to be applied.

CAST-IN-PLACE CONCRETE

03300-6

CAST-IN-PLACE CONCRETE

03300-7

- B. Removal of Forms: Prevent concrete damage during form removal. After placing concrete, forms shall remain in place for a minimum time period equal to the curing period. Forms may be removed earlier than specified if ASTM C39 test results of field-cured samples from a representative portion of the structure indicate that the concrete has reached 85 percent (minimum) of the design strength.

3.2

PLACING REINFORCEMENT AND MISCELLANEOUS MATERIALS

ACI 301. Provide bars, wire fabric, wire ties, supports and other devices necessary to install and secure reinforcement. Reinforcement shall not contain rust, scale, oil, grease, clay, and foreign substances that would reduce the bond. Rusting of reinforcement is a basis for rejection if the effective cross sectional area or the nominal weight per foot of the reinforcement has been reduced to less than specified in paragraph entitled "Reinforcing Bars." Remove loose rust prior to placing steel. Tack welding is prohibited.

- A. Tolerances: Place reinforcement and secure with galvanized or non-corrodible chairs, spaces, or metal hangers. Use concrete or other non-corrodible material for supporting reinforcement on the ground.
- B. Splicing: AWS D1.4, except as otherwise indicated or specified. Splices shall be approved prior to use. Do not splice at points of maximum stress. Overlap welded wire fabric the spacing of the cross wires, plus 2 inches.
- C. Future Bonding: Plug exposed, threaded, mechanical reinforcement bar connectors with a greased bolt. Bolt threads shall match the connector. Countersink the connector in the concrete. Caulk the depression after the bolt is installed.
- D. Cover: ACI 301 for minimum coverage, unless otherwise indicated.
- E. Setting Miscellaneous Material: Place and secure anchors and bolts, pipe sleeves, conduits, and other such items in position before concrete placement. Plumb anchor bolts and check location and elevation. Temporarily fill voids in sleeves with readily removal material to prevent the entry of concrete.
- F. Construction Joints: Locate joints to least impair strength. Continue reinforcement across joints unless otherwise indicated.
- G. Expansion joints and Contraction Joints: For slabs on grade, provide as shown on the drawings or as otherwise specified herein. Provide contraction joints, either formed or saw cut or cut with a jointing tool, to the indicated depth after the surface has been finished. Sawed joints shall be completed within 4 to 12 hours after concrete placement. Protect joints from intrusion of foreign matter.
- H. Form Ties and Accessories: The use of wire alone is prohibited. Form ties and accessories shall not reduce the effective cover of the reinforcement.

3.3

MEASURING, MIXING, TRANSPORTING, AND PLACING CONCRETE

ASTM C94, ACI 301, ACI 302.1R, and ACI 304, except as modified herein. ASTM C94. Provide mandatory batch ticket information for each load of ready mix concrete.

- A. Measuring: Make moisture, weight, and air determinations at intervals as specified in paragraph entitled "Sampling and Testing." Allowable tolerances for measuring cement

- and water shall be 1 percent; for aggregates, 2 percent; and for admixtures, 3 percent.
- B.** Mixing: ASTM C94. Machine mix concrete. Begin mixing within 30 minutes after the cement has been added to the aggregates. Place concrete within 90 minutes of either addition of the mixing water to cement and aggregates or addition of cement to aggregates if the air temperature is less than 85 degrees F. Reduce mixing time and place concrete within 60 minutes if the air temperature is greater than 85 degrees F. Additional water may be added, provided that both the specified maximum slump and water-cement ratio are not exceeded. Dissolve admixtures in the mixing water and mix in the drum to uniformly distribute the admixture throughout the batch.
- C.** Transporting: Transport concrete from the mixer to the forms as rapidly as practicable. Prevent segregation or loss of ingredients. Clean transporting equipment thoroughly before each batch. Do not use aluminum pipe or chutes. Remove concrete, which has segregated in transporting, and dispose of as directed.
- D.** Placing: Place concrete as soon as practicable after the forms and the reinforcement have been inspected and approved. Do not place concrete when weather conditions prevent proper placement and consolidation; in uncovered areas during periods of precipitation; or in standing water. Prior to placing concrete, remove dirt, construction debris and water from within the forms. Deposit concrete as close as practicable to the final position in the forms. Do not exceed a free vertical drop of 3 feet from the point of discharge. Place concrete in one continuous operation from one end of the structure towards the other. Position grade stakes on 10-foot centers maximum in each direction when pouring interior slabs and on 20-foot centers maximum for exterior slabs.
- E.** Vibration: ACI 301. Furnish a spare vibrator on the job site whenever concrete is placed. Consolidate concrete slabs greater than 4 inches in depth with high frequency, internal, mechanical vibrating equipment supplemented by hand spading and tamping. Consolidate concrete slabs 4 inches or less in depth by wood tampers, spading, and settling with a heavy leveling straight edge. Operate vibrators with vibratory element submerged in the concrete, with a minimum frequency of not less than 6000 impulses per minute when submerged. Do not use vibrators to transport the concrete in the forms. Insert and withdraw vibrators approximately 18 inches apart. Penetrate the previously placed lift with the vibrator when more than one lift is required. Place concrete in 18-inch maximum vertical lifts. External vibrators shall be used on the exterior surface of the forms when internal vibrators do not provide adequate consolidation of the concrete.
- 2.** Application of Epoxy Bonding Compound: Apply a thin coat of compound to dry, clean surfaces. Scrub compound into the surface with a stiff-bristle brush. Place concrete while compound is stringy. Do not permit compound to harden prior to concrete placement. Follow manufacturer's instructions regarding safety and health precautions when working with epoxy-resins.
- E.** Hot Weather: ACI 305R. Provide and maintain required concrete temperature using Figure 2.1.5 in ACI 305R to prevent the evaporation rate from exceeding 0.2 pound of water per square foot of exposed concrete per hour. Cool ingredients before mixing or use other suitable means to control concrete temperature and prevent rapid drying of newly placed concrete. Shade the fresh concrete as soon as possible after placing.
- Start curing when the surface of the fresh concrete is sufficiently hard to permit curing without damage. Provide water hoses, pipes, spraying equipment, and water hauling

CAST-IN-PLACECONCRETE 03300-8

CENTRAL POLICE PRECINCT

(where worksite is remote to water source) to maintain a moist concrete surface throughout the curing period. Provide burlap cover or other suitable, permeable material with fog spray or continuous wetting of the concrete when weather conditions prevent the use of either liquid membrane curing compound or impervious sheets.

For vertical surfaces, protect forms from direct sunlight and add water to top of structure once concrete is set.

### 3.4 FINISH OF FORMED SURFACES

- A.** CF-1 Rough Formed Finish: For formed concrete surfaces not exposed-to-view in the finished work or by other construction, unless otherwise indicated. This is the concrete surface having texture imparted by form facing material used, with tie holes and defective areas repaired and patched and fins and other projections exceeding 1/8" in height rubbed down or chipped off.
- B.** CF-2 Smooth Form Finish: For exterior formed concrete surfaces exposed-to-view other than roofs. This is as-cast concrete surface obtained with selected form facing material, arranged orderly and symmetrically with a minimum of seams. Repair and patch defective areas with fins or other projections completely removed and smoothed. For all walls to be painted with (EAHE).
- C.** CF-3 Skim Coat Finish: For all interior formed surfaces exposed-to-view, provide skim coat finish. Apply over all contiguous surfaces.
- D.** Related Uniform Surfaces: At top of walls, horizontal offsets, and similar uniformed surfaces occurring adjacent to formed surfaces, strike-off smooth and finish with a texture matching adjacent formed surfaces. Continue final surface treatment of formed surfaces uniformly across adjacent uniformed surfaces, unless otherwise indicated.

### 3.5 FLOOR, SLAB, AND PAVEMENT FINISHES AND MISCELLANEOUS CONSTRUCTION

ACI 302.1R, unless otherwise specified.

- A.** Finishing: Place, consolidate and immediately strike off concrete to obtain proper contour, grade, and elevation before bleed water appears. Permit the concrete to attain a set sufficient for floating and sufficient to support the weight of the finisher and equipment. If bleed water is present prior to floating the surface, drag the excess water off or remove by absorption by porous materials. Do not use dry cement to absorb bleed water.
- 1.** Floated: Provide for machinery pads and other exterior slabs where not otherwise specified. Float the surface by hand with a wood or magnesium float, or use a power-driven float. Floating of any one area shall be the minimum necessary to produce an even finish, level within 1/4 inch in 10 feet for exterior work.
- 2.** Steel Troweled: First, provide a floated finish. When slab has attained a proper set, hand- or machine-trowel to a smooth, hard, dense finish. Finished surfaces shall be free of troweled marks, uniform in texture, and have true plane, flat within 0.01 foot (approximately 1/8 inch) in 10 feet. Hand-finish portions of the slab not accessible to power finishing equipment (e.g., edges, corners) to match the remainder of the slab. Power trowel once and finally hand trowel where a finished floor covering (e.g. tile, carpet) is specified. Power trowel twice and finally hand trowel for exposed concrete floors.

CAST-IN-PLACECONCRETE

03300-9

3.

### 3.6 CURING AND PROTECTION

ACI 301 unless otherwise specified. Begin curing immediately following form removal. Protect concrete from injurious action by sun, rain, flowing water, mechanical injury, fire marks, and oil stains. Do not allow concrete to dry out from time of placement until expiration of the specified curing period. Do not use membrane-forming compound on surfaces where appearance would be objectionable, or on any surface to be painted, where coverings are to be bonded to the concrete, or on concrete to which other concrete is to be bonded. If forms are removed prior to the expiration of the curing period, provide another curing procedure specified herein for the remaining portion of the curing period.

- A. Moist Curing: Provide for the removal of water without erosion or damage to the structure.
1. Ponding or Immersion: Continually immerse the concrete throughout the curing period. Water shall not be more than 20 degrees F less than the temperature of the concrete.
  2. Fog Spraying or Sprinkling: Provide uniform and continuous application of water throughout the curing period.
  3. Pervious Sheeting: Completely cover surface and edges of the concrete with two thicknesses of wet sheeting. Overlap sheeting 6 inches over adjacent sheeting. Sheeting shall be at least as long as the width of the surface to be cured. During application, do not drag the sheeting over the finished concrete nor over sheeting already placed. Wet sheeting thoroughly and keep continuously wet throughout the curing period.
  4. Impervious Sheeting: Wet the entire exposed surface of the concrete thoroughly with a fine spray of water and cover with impervious sheeting throughout the curing period. Lay sheeting directly on the concrete surface and overlap edges 12 inches minimum. Provide sheeting not less than 18 inches wider than the concrete surface to be cured. Secure edges and transverse laps to form closed joints. Repair torn or damaged sheeting or provide new sheeting. Cover or wrap columns, walls and other vertical structural elements from the top down with impervious sheeting, overlap and continuously tape sheeting joints, and introduce sufficient water to soak the entire surface prior to completely enclosing.

B. Liquid Membrane-Forming Compound Curing: Seal or cover joint openings prior to application of curing compound. Prevent curing compound from entering the joint. Provide and maintain compound on the concrete surface throughout the curing period. Do not use this method of curing where the use of Figure 2.1.5 in ACI 305R indicates that hot weather conditions will cause an evaporation rate exceeding 0.2 pound of water per square foot per hour.

1. Applications: Unless the manufacturer recommends otherwise, apply compound immediately after the surface loses its water sheen and has a dull appearance, and before joints are sawed. Mechanically agitate curing compound thoroughly during use. Use approved power-spraying equipment to uniformly apply two coats of compound in a continuous operation. The total coverage for the two coats shall be 200 square feet maximum per gallon of undiluted compound unless otherwise recommended by the manufacturer's written instructions. The compound shall form a uniform, continuous, coherent film that will not check, crack, or peel. Immediately apply an additional coat of compound to areas where

the film is defective.

- C. Protection of Treated Surfaces: Prohibit foot and vehicular traffic and other sources of abrasion for not less than 72 hours after compound application. Maintain continuity of the coating for the entire curing period and immediately repair any damage.
- D. Curing Periods and Minimum Temperatures: After placing concrete, maintain air temperature adjacent to the concrete at 50 degrees F minimum for the specified period, or 70 degrees minimum for a period of 3 days after placing and, and 40 degrees F minimum for the remainder of the specified time period.

### 3.7 SAMPLING AND TESTING

- A. Sampling: ASTM C172. Collect samples of fresh concrete to perform tests specified. ASTM C31 for making test specimens.
- B. Testing:
1. Slump Tests: ASTM C143. Take concrete samples during concrete placement. The maximum slump may be increased as specified with the addition of an approved admixture provided that the water-cement ratio is not exceeded. Perform tests at commencement of concrete placement, when test cylinders are made, and for each batch (minimum) of every 10 cubic yards (maximum) of concrete.
  2. Compressive Strength Tests: ASTM C39. Make five test cylinders for each set of tests in accordance with ASTM C31. Test two cylinders at 7 days, two cylinders at 28 days, and hold one cylinder in reserve. Provide concrete cylinders for compressive tests not less than once a day, nor less than once for each 150 cubic yards of concrete, nor less than once for each 5,000 square feet of surface area for slabs and walls. Double the cylinder collection frequency and number of batches sampled when pumping concrete. If the average strength of the 28-day test cylinders is less than the compressive strength and a maximum of one single cylinder is less than  $f_c$  is minus 300 psi, take three ASTM C42 core samples and test. If the average strength of the 28-day test cylinders is less than  $f_c$  and two or more cylinders are less than  $f_c$  minus 300 psi, take six core samples and test. Concrete represented by core tests shall be considered structurally adequate if the average of three cores is equal to at least 85 percent of  $f_c$  and if no single core is less than 75 percent of  $f_c$ . Locations represented by erratic core strengths shall be retested. Remove concrete not meeting strength criteria and provide new, acceptable concrete. Repair core holes with non-shrink grout. Match color and finish of adjacent concrete.

END OF SECTION 03300

CAST-IN-PLACECONCRETE

03300-10

CAST-IN-PLACECONCRETE

03300-11



SECTION 03301

MISCELLANEOUS CONCRETE STRUCTURES

PART 1 - GENERAL

- 1.1 **QUALITY CONTROL:** The Quality Control of Division 1, apply to this section.
- 1.2 **GENERAL REQUIREMENTS:** The construction requirements of this section apply to concrete sidewalks, driveways, and concrete-paved drainage swales, with reinforcement, conforming to the lines and grades shown on the plans.
- A. **Earthwork:** Unless otherwise specified in this section or on the plans, the earthwork requirements of Section 02200, entitled "Earthwork", shall also apply to this section.
- B. **Concrete Construction:** Unless otherwise specified in this section, or on the plans, the concrete construction requirements of Section 03300, entitled "Cast-in-Place Concrete", shall also apply to this section.

PART 2 - PRODUCTS

- 2.1 **General:** Products mentioned in Section 03300, Cast-in-Place Concrete shall also apply to this section.

PART 3 - EXECUTION

3.1 **CONSTRUCTION REQUIREMENTS**

- A. **Concrete Walkways:** This work shall consist of the construction of concrete walkways, sidewalks, or concrete slabs in accordance with these specifications and in reasonably close conformity with the lines and grades shown on the plans or established by the Contracting Officer.
1. **Excavation:** Excavation shall be made to the required depth and to a width that will permit the installation and bracing of the forms. The foundation shall be shaped and compacted to an even surface conforming to the section shown on the plan. All soft and yielding material shall be removed and replaced with acceptable material, which shall be thoroughly compacted to the degree indicated on the plans.
  2. **Forms:** Forms shall be of wood or metal and shall extend for the full depth of the concrete. All forms shall be straight, free from warp and of sufficient strength to resist the pressure of the concrete without springing. Bracing and staking of forms shall be such that the forms remain in both horizontal and vertical alignment until their removal.
  3. **Placing Concrete:** The foundation shall be thoroughly moistened immediately prior to the placing of the concrete. The proportioning, mixing and placing of the concrete shall be in accordance with the requirements of Section 03300, entitled "Cast-in-Place Concrete".
  4. **Finishing:** The surface shall be finished with a wooden float. No plastering of the surface will be permitted. All outside edges of the slab and all joints shall be edged with a 1/4 inch radius edging tool.
  5. **Joints:** Expansion joints shall be of the dimensions specified, and shall be filled with the type of pre-molded expansion joint filler. The sidewalk shall be divided into sections by dummy joints formed by a jointing tool or other acceptable means as

MISCELLANEOUS CONC. STRUCTURES 03301-1

directed. These dummy joints shall extend into the concrete for at least 1/3 of the depth and shall be approximately 1/8 inch wide.

6. Construction joints shall be formed around all appurtenances such as manholes, utility poles, etc., extending into and through the installed in these joints. Expansion joint filler of the thickness indicated shall be installed between concrete sidewalks and any fixed structure such as a building or bridge. This expansion joint material shall extend for the full depth of the sidewalk.
  7. **Curing:** Concrete shall be cured for at least 72 hours. Curing shall be by means of moist burlap or mats or by other approved methods.
  8. **Base Course Material:** Base Course Material for sidewalks and driveways shall conform to the requirements for base course in Section 02203, entitled "Base Course".
- B. **Concrete Curbing:** This work shall consist of the construction of curb, gutter or combination curb and gutter in accord with these specifications and in reasonably close conformity with the lines and grades shown on the plans or established by the Architect.
1. **Excavation:** Excavation shall be made to the required depth, and based upon which the curb is to be set shall be compacted to an even surface. All soft and unsuitable material shall be removed and replaced with suitable material which shall be thoroughly compacted to the degree indicated on the plans.
  2. **Forms:** Forms shall be of wood, metal, or other suitable material and shall extend for the full depth of the concrete. All forms shall be straight, free from warp and of sufficient strength to resist the pressure of the concrete without displacement. Bracing and staking of forms shall be such that the forms remain in both horizontal and vertical alignment until their removal. All forms shall be cleaned and coated with an approved form release agent before concrete is placed. Divider plates shall be of metal.
  3. **Mixing and Placing:** Concrete shall be proportioned, mixed and placed in accordance with the requirements of Section 03300, entitled "Cast-In-Place Concrete". Consolidation of concrete placed in the forms shall be by vibration or other acceptable methods. Forms shall be left in place for 24 hours or until the concrete has set sufficiently so that they can be removed without injury to the curbing. The concrete shall be struck off to the cross-section specified, after which it shall be finished smooth and even by means of a wood float.  
For the purpose of matching adjacent concrete finishes or for other reasons, the Architect may permit other methods of finishing. No plastering will be permitted.
  4. **Sections:** Curbing shall be constructed in sections having a uniform length as shown on the plans unless otherwise directed by the Engineer. Sections shall be separated by open joints 1/8 inch wide except at expansion joints. Where the curb is constructed adjacent to concrete pavement, the construction or open joints in the curb shall match the contraction joints in the pavement.
  5. **Expansion Joints:** Expansion joints shall be formed at the intervals shown on the plans using a pre-formed expansion joint filler having a thickness of 1/2 inch. When the curb is constructed adjacent to or on concrete pavement, expansion joints shall be located opposite or at expansion joints in the pavement.
  6. **Curing:** Immediately upon completion of the finishing, the curbing shall be moistened and kept moist for three (3) days, or the curbing shall be cured by the use of membrane forming material. The method and details of curing shall be subject to the

MISCELLANEOUS CONCRETE STRUCTURES 03301-2

approval of the Architect.

7. Backfilling: After the concrete has set sufficiently, the spaces in from and back of the curb shall be refilled to the required elevation with suitable material, which shall be thoroughly tamped, in layers of not more than eight inches thick.

C. **Drainage Swales:** This work shall consist of paving ditches or other similar waterways with concrete constructed on a prepared bed in reasonably close conformity with these specifications and with the lines, grades and dimensions shown on the plans or established by the Architect.

1. Excavation: Excavation shall be made to the required depth, and the base upon which the curb is to be set shall be compacted to an even surface. All soft and unsuitable material shall be removed and replaced with suitable which shall be thoroughly compacted to the degree indicated on the plans.
2. Forms: Forms shall be of wood, metal, or other suitable material and shall extend for the full depth of the concrete. All forms shall be straight, free from warp and of sufficient strength to resist the pressure of the concrete without displacement. Bracing and staking of forms shall be such that the forms remain in both horizontal and vertical alignment until their removal. All forms shall be cleaned and coated with an approved form release agent before concrete is placed.
3. Mixing and Placing: Concrete shall be proportioned, mixed and placed in accordance with the requirements of Section 03300, entitled "Cast-in-Place Concrete". Consolidation of concrete placed in the forms shall be by vibration other acceptable methods. Forms shall be left in place for 24 hours or until the concrete has set sufficiently so that they can be removed without injury to the structure. The concrete shall be struck off to the cross-section specified, after which it shall be finished smooth and even.
4. Sections: Swales shall be constructed in sections as shown on the plans unless otherwise ordered.
5. Curing: Immediately upon completion of the finishing, the structure shall be moistened and kept moist for three days. The method and details of curing shall be subject to the approval of the Architect.
6. Backfilling: After the concrete has set sufficiently, the spaces shall be refilled to the required elevation with suitable material, which shall be thoroughly tamped, in layers of not more than eight (8) inches thick.
7. Base Course Material: Base course material for concrete curbing shall conform to the requirements Section 02203, entitled "Base Course".

**END OF SECTION**

SECTION 03350  
CONCRETE FINISHES

PART 1 GENERAL

1.1 SUMMARY

- A. Section includes:
1. Finishes for cast-in-place concrete.
- B. Related Documents: The Contract Documents, as defined in Section 01010 - Summary of Work, apply to the work of this Section. Additional requirements and information necessary to complete the work of this Section may be found in other Documents.
- C. Related Sections:
1. Section 03300 – Cast-in-Place Concrete: Substrate for finishing.
  2. Section 07190 - Water Repellents (Sealer): Substrate waterproof sealer.
  3. Section 09900 – Painting: Finishing.

1.2 DESCRIPTION OF WORK

- A. The extent of the concrete finishes work is indicated on the Drawings and Schedules and as specified herein, and includes providing materials and applying to in-place concrete surfaces.
- B. Materials and work specified herein, are in addition to the work under Division 3 – CONCRETE, and are required to achieve the specified finishes.

1.3 REFERENCES

- A. American Concrete Institute (ACI):
1. Applicable provisions.
- B. American Society for Testing and Materials (ASTM):
1. ASTM E 1155 - Test Method for Determining FF Floor Flatness and FL Floor Level Numbers.
- C. Americans with Disabilities Act Accessibility Guidelines (ADAAG):
1. Accessibility Guidelines for Buildings and Facilities.
  2. Accessibility Guidelines for Building Elements Designed for Children's Use.

1.4 SUBMITTALS

- A. Section 01330 – Submittal Procedures: Procedures for submittals.
1. Product Data: Manufacturer's technical information and application instructions

CONCRETE FINISHES  
03350-4

MISCELLANEOUS CONC. STRUCTURES 03301-3

- A. In addition to materials required to achieve the finishes specified herein, comply with Division 3 - CONCRETE Sections.
  - B. Form Coatings: Form coatings shall not bond with, stain, or adversely affect concrete surfaces, and shall not impair subsequent treatment of concrete surfaces.
- 2.2 CONCRETE MATERIALS
- A. In addition to materials required to achieve the finishes specified herein, comply with Division 3 - CONCRETE Sections.
  - B. Skim Coat Cement Finish: (CF-3) Cement based polymer modified, quick setting concrete finishing material; dry powder blend of Portland Cement and acrylic additives designed specifically for application to concrete surfaces for a Class A finish. Fine finish texture. LAHABRA ACRYLIC FINISH, PRO-FINISH by Bonded Materials Co., or approved equal.
  - C. Hardening / Sealing Agent for polished finish (CF-9)
    - 1. Advanced Floor Products; Retro-Plate 99
    - 2. Eloco: Ironshine HG
- 2.3 RELATED MATERIALS
- A. Salt: Coarse salt, 100% passing 3/8" sieve and 85% remaining on #8 sieve. Morton Softener Salt, Somat Water Softener Salt, North American Salt or approved product by another company.
  - B. Curing Materials: Comply with Division 3. - CONCRETE Sections.
- 2.4 MIXES
- A. Comply with Division 3 - Concrete Sections.
- PART 3 EXECUTION
- 3.1 EXAMINATION
- A. Section 01700 - Execution Requirements: Verification of existing conditions before starting the work.
  - B. Verification of Conditions: Verify that surfaces, substrates and conditions are as required, and ready to receive the work.
  - C. Report, in writing, prevailing conditions that will adversely affect satisfactory execution of the work of this Section. Do not proceed with the work until the unsatisfactory conditions have been corrected.
- 3.2 FINISH OF FORMED SURFACES
- A. (CF-1) Rough Formed Finish: Formed concrete surfaces not exposed-to-view in the finished work or by other construction, unless otherwise indicated. Concrete surfaces having texture imparted by the form facing material used, with tile holes and defective areas repaired and patched, and fins and other projections, exceeding 1/4" in height, rubbed down or chipped off.
- CONCRETE FINISHES 03350-3 CENTRAL POLICE PRECINCT

- for the materials required.
- 2. Shop Drawings (if requested): Layout drawings and details for proper installation of the work.
  - 3. Mock-Up: Construct a Mock-Up of 4' x 8', minimum size, not as part of work, to be reviewed for quality of workmanship and finish. Prior to beginning the Mock-Up, secure the Owner representative's general approval of the application technique to be used.
  - 4. Assurance / Control Submittals:
    - a. Documentation of experience indicating compliance with the specified qualifications requirements.
- 1.5 COORDINATION
- A. Concrete Characteristics. Without changing the design intent, it is required that the concrete characteristics, such as moisture content, pH levels, finish texture, and any materials used in conjunction with the concrete work meet the requirements of other work to be applied to and into it and whose performance, in part or whole, depends upon the concrete work provided. Verify and coordinate requirements with other installers providing such work prior to the construction of each structure affecting such installers.
- 1.6 QUALITY ASSURANCE
- A. Qualifications:
    - 1. Manufacturer: Company specializing in manufacturing the products specified with a minimum of five (5) years documented experience.
    - 2. Applicator / Installer: Company experienced in performing the work of this Section with a minimum of five (5) years documented experience.
- 1.7 DELIVERY, STORAGE AND HANDLING
- A. Section 01600 - Product Requirements. Transport, handle, store, and protect the products.
  - B. Deliver products to the Project Site in the manufacturer's original, new and unopened packages or containers with seals and labels intact; dry and undamaged, bearing the product name, and precautionary labels.
  - C. Store materials not in actual use, in tightly enclosed containers. Maintain containers used in the storage of materials, in a clean condition, free of foreign materials and residue.
  - D. Store materials in a well-ventilated area, and in compliance with the manufacturer's published instructions.
  - E. Store and handle materials to prevent deterioration and damage due to moisture, temperature changes, contaminants, and other causes.
- PART 2 PRODUCTS
- 2.1 FORM MATERIALS 03350-2
- CONCRETE FINISHES

- D. (CF-2) Smooth Form Finish: Formed concrete surfaces exposed-to-view, or that are to be covered with a coating material applied directly to the concrete, or a covering material applied directly to the concrete, such as waterproofing, dampproofing, veneer plaster, paint, wall covering or other similar materials. As-cast concrete surfaces resulting from selected form facing material, arranged orderly and symmetrically with a minimum of seams. Repair and patch defective areas with fins or other projections completely removed and ground smooth.
- C. (CF-3) Skim Coat Finish: Formed surfaces exposed-to-view, provided with a skim coat finish, smooth or textured as indicated or selected by owner's representative. Apply over all contiguous surfaces.
- D. Related Un-formed Surfaces: Tops of walls, horizontal offsets, and similar un-formed surfaces adjacent to formed surfaces. Strike-off smooth and finish with a texture matching the adjacent formed surfaces. Continue final surface treatment of the formed surfaces uniformly across adjacent un-formed surfaces, unless otherwise indicated.

### 3.3 MONOLITHIC SLAB FINISHES

- A. Floor Flatness Standard: ASTM E1155, with "F" number requirements as specified herein.
- B. (CF-4) Float Finish:
1. Location: Apply on surfaces to receive a trowel finish, and as otherwise indicated.
  2. Installation: After screeding, consolidating, and leveling concrete slabs, do not work the surface until ready for floating.
  3. Begin floating when surface water has disappeared or when the concrete has stiffened sufficiently to permit operation of power driven floats, or both. Consolidate surface with power driven floats or by hand floating if the area is small or inaccessible to power units. Check and level the surface plane and uniformly slope surfaces to drains. Immediately after leveling, refloat the surface to a uniform, smooth, granular texture.

- C. (CF-5) Trowel Finish:
1. Location: Apply to the following surfaces, and as otherwise indicated.
    - a. In general, apply to all exposed-to-view surfaces with no tile or stone finishes scheduled to be applied.
    - b. Surfaces to receive water repellent sealer.
    - c. Surfaces to receive carpet.
    - d. Surfaces to receive resilient flooring.
    - e. Surfaces to receive paint coatings.
  2. Installation: After floating, begin first finish operation using a power driven trowel. Begin final troweling when surfaces produce a ringing sound as trowel is moved over the surface. Consolidate concrete surfaces by final hand troweling, free of trowel marks, uniform in texture and appearance, and with the surfaces leveled. Grind smooth surface defects that will telegraph through an applied floor finish.

CONCRETE FINISHES  
03350-4

- D. (CF-6) Trowel with Fine Broom Finish:
1. Location: Apply to the following surfaces, and as otherwise indicated.
    - a. Vehicular traffic surfaces which are not ramps.
    - b. Pedestrian (foot trafficked) concrete surfaces, such as walkways, ramps, and stairs.
    - c. Surfaces to receive mortarbed or thinset tile or stone.
  2. Installation: Apply trowel finish as specified herein, then immediately follow by slightly scarifying the surface to a 1/16" maximum profile with a fiber bristle broom or brush.
  3. Profile, Texture, and Pattern:

- a. Vehicular and Pedestrian Traffic Surfaces: Verify profile, texture, and pattern with the Owner's representative, and provide in accordance with directions. Apply perpendicular to the direction of traffic, or as otherwise instructed.
- b. Tile / Stone and Waterproofed Surfaces: Verify scarifying profile with the Installer of the final exposed finish.

### E. (CF-7) Scored (Rib) Finish:

1. Location: Apply to vehicular and pedestrian ramps, and as otherwise indicated.
2. Installation: Apply trowel finish as specified herein, then immediately follow with a scoring machine or tool leaving raked ribs perpendicular to the vehicular traffic direction, nominal 1/8" x 1/8" profile, at 2" o.c., or such other pattern and profile, as approved.

### F. (CF-8) Salt Finish:

1. Location: As indicated.
2. Installation: Distribute at the rate of not less than 5 lb / 100 sf, or as otherwise approved by the Owner's representative, or as determined by an approved Mock-Up. Washout salt when concrete has set.

### G. Water Repellent Sealer Finish:

1. Location: Apply to the following surfaces, and as otherwise indicated.
  - a. In general, apply to all surfaces in which concrete is scheduled to be exposed to view and not scheduled to receive a tile, stone, carpet, or resilient floor finish.
  - b. Pedestrian (foot trafficked) concrete surfaces, such as walkways and stairs.
3. Installation: Apply sealer / hardener after complete curing and drying of concrete surfaces. Apply proprietary materials in strict accordance with the manufacturer's printed instructions.

CONCRETE FINISHES  
03350-5

- H. (CF-9) Polished Finish:
1. Apply to floors where indicated.
  2. Performance Criteria:
    - a. Abrasion Resistance: ASTM C779
    - b. Impact Strength: ASTM C805
    - c. Ultra Violet Light and Water Spray: ASTM G23
  4. Sealing, Hardening and Polishing of Concrete Surface
    - a. Concrete must be in place a minimum of 45 days or as directed by the manufacturer before application can begin.
    - b. Only a certified applicator shall apply sealer and hardener. Applicable procedures must be followed as recommended by the product manufacturer and as required to match approved test sample.
    - c. Achieve water repellency, hardening, dust proofing, and abrasion resistance of the surface without changing the natural appearance of the concrete, except for the sheen.
    - d. The Sealing, Hardening and Polishing procedures shall be in strict accordance with the manufacturer's Standard Installation Methods for the product.
    - e. Upon completion of concrete finish application, clean areas to be striped to remove any debris and residue.
    - f. Provide Lust value test results.
- 3.4 CONCRETE SURFACE REPAIRS
- A. Non-Structural Defects: Repair the following types of defects.
1. Exposed-to-View Surfaces.
  2. Cracks: Repair and fill all cracks, which affect durability of the concrete.
  3. Voids: Repair all spalls, air bubbles, honeycomb, rock pockets, bug holes, tile holes, and other voids larger than a pinhole (1/16").
  4. Projections: Remove fins and other projections from surfaces.
  5. Color / Texture Irregularities: Remove stains and other discolorations.
  6. High Areas on Slabs: Correct surfaces by grinding after the concrete has cured at least fourteen (14) days.
  7. Low Areas on Slabs: Correct surfaces during or immediately after completion of surface finishing operations by cutting out low areas and replacing with fresh concrete. Finish repaired areas to blend into adjacent concrete. Proprietary patching compounds may be used when approved by the Owner's

CONCRETE FINISHES 03350-6

representative.

8. Concealed Surfaces: Repair defects that affect durability of the concrete. If defects cannot be repaired, remove and replace with new concrete. Where waterproofing materials are indicated, remove projections and defects necessary for proper waterproofing of the surfaces in conformance with instructions of the waterproofing manufacturer.
  9. Non-Structural Repairs: Utilize polymer-reinforced mortar patching materials in strict accordance with the material manufacturer's written instructions. Provide appropriate aggregate sizes for the depth of the area to be repaired. Finish smooth to blend with adjacent surfaces.
  10. Structural Repairs: Perform structural repairs with prior approval of the Owner's representative for method and procedure, using epoxy adhesive and mortar.
- E. Color / Texture Repair: Even out the color / texture appearance of all exposed-to-view formed surfaces with a wash finish where not required to be opaque painted or where irregularities can telegraph through the final finish.
- 3.5 CLEANING
- A. Section 01700 - Execution Requirements: Cleaning the installed work.
  - B. Upon completion of the finishing work, clean all surfaces free of foreign matter.
  - C. Clean surfaces with acid solutions only when permitted by the Owner's representative. Protect metal surfaces and cast iron from the effects of acid cleaning. Flush surfaces with clean water before and after cleaning.
  - D. Leave finished installations clean and free of cracks, chips, and otherwise defective work.
- 3.6 PROTECTION
- A. Protect finish work with Kraft paper or other heavy covering to prevent staining, damage and wear.
  - B. Immediately before final inspection, remove the protective coverings and rinse with clean, potable water.

END OF SECTION

CONCRETE FINISHES 03350-7

SECTION 04200

UNIT MASONRY

PART 1 GENERAL

1.1 REFERENCES

The publications listed below form a part of this specification to the extent referenced. The publications are referred to in the text by the basic designation only.

AMERICAN SOCIETY FOR TESTING AND MATERIALS (ASTM)

- ASTM A 82 Steel Wire, Plain, for Concrete Reinforcement
- ASTM A 153 Zinc Coating (Hot-Dip) on Iron and Steel Hardware
- ASTM A 167 Stainless and Heat-Resisting Chromium-Nickel Steel Plate, Sheet, and Strip
- ASTM A 615 Deformed and Plain Billet-Steel Bars for Concrete Reinforcement
- ASTM B 370 Copper Sheet and Strip for Building Construction
- ASTM C 90 Load-Bearing Concrete Masonry Units
- ASTM C 91 Masonry Cement
- ASTM C144 Aggregate for Masonry Mortar
- ASTM C 150 Portland Cement
- ASTM C 207 Hydrated Lime for Masonry Purposes
- ASTM C 270 Mortar for Unit Masonry
- ASTM C 476 Grout for Masonry

1.2 SUBMITTALS

Submit the following in accordance with Section 01300, "Submittals."

1.2.1 Manufacturer's Catalog Data

- a. Masonry accessories
- b. Reinforcement
- c. Flashing

Submit for each type.

1.2.2 Drawings

- a. Reinforcing steel
- b. Drawing Requirements

UNIT MASONRY

04200-1

Indicate splicing, laps, shapes, dimensions, and details of reinforcing steel and accessories. Include details of anchors, adjustable wall ties, positioning devices, bond beams, and lintels. Do not scale drawings to determine lengths of bars.

1.2.3 Design Data

- a. Pre-mixed mortar

1.2.4 Instructions

- a. Masonry cement

When masonry cement is used, submit the manufacturer's printed instructions on proportions of water and aggregates and on mixing to obtain the type of mortar required.

1.2.5 Samples

- a. Masonry units

Submit two sets of each type masonry units, showing full range of color, texture, finish, and dimensions.

1.3 QUALITY ASSURANCE

1.3.1 Appearance

Do not change source or supply of materials after work has started if the appearance of the finished work would be affected.

1.4 DELIVERY, STORAGE, AND HANDLING

Deliver cementitious materials to the site in unbroken containers, plainly marked and labeled with manufacturers' names and brands. Store cementitious materials in dry, weather-tight sheds or enclosures. Handle so as to prevent entry of foreign materials and damage by water or dampness. Store masonry units off the ground and handle with care to avoid chipping and breakage. Protect materials from damage and, except for sand, keep dry until used. Cover sand to prevent intrusion of water and foreign materials and to prevent drying. Do not use materials containing frost or ice. Store Type II concrete masonry units at the site before using for a minimum of 28 days for air cured units, 10 days for atmospheric steam or water cured units, and 3 days for units cured with steam at a pressure of 120 to 150 psi and at a temperature of 350 to 365 degrees F for at least 5 hours.

1.5 SCHEDULING

Coordinate masonry work with the work of other trades to accommodate built-in items and to avoid cutting and patching.

PART 2 PRODUCTS

2.1 MASONRY UNITS

2.1.1 Concrete Masonry Units

Units of modular dimensions and air, water, or steam cured. Surfaces of units which are to be plastered shall be sufficiently rough to provide bond; elsewhere, exposed surfaces of units shall be

UNIT MASONRY

04200-2

smooth and of uniform texture. Exterior concrete masonry units shall have water-repellent admixture added during manufacture.

a. Hollow Load-Bearing Units

ASTM C 90, Type I or II, made with or normal weight aggregate. Provide load-bearing units for exterior walls, foundation walls, load-bearing walls, and shear walls.

b. Special Shapes

Provide special shapes such as closures, header units, and jamb units as necessary to complete the work. Special shapes shall conform to the requirements for the units with which they are used.

2.1.2 Pre-cast Concrete Lintels

Same materials and surface texture as adjacent masonry units, with a 28-day compressive strength of not less than 3000 psi. Provide reinforcing as indicated. Provide lintels of sizes indicated, with at least 8 inches of bearing at each end.

2.2 MORTAR

2.2.1 Portland Cement

ASTM C 150, Type I, II, or III.

2.2.2 Hydrated Lime

ASTM C 207, Type S.

2.2.3 Masonry Cement

ASTM C 91, except that for masonry cement provided for mortar for exterior walls, the air content of the mortar specimen shall be not more than 16 percent by volume in lieu of 22 percent. Containers shall bear complete instructions for proportioning and mixing to obtain the required types of mortar.

2.2.4 Sand

ASTM C 144.

2.2.5 Water

Clean, potable, and free from substances which could adversely affect the mortar.

2.2.6 Mortar Types

ASTM C 270, Type S for masonry work; except where higher compressive strength is indicated on structural drawings. Air content shall not be less than 11 percent.

2.2.7 Pre-Mixed Mortar

ASTM C 270, Type S, compressive strength of 1800 psi in 28 days. Air content shall not be less than 11 percent. Admixtures may be provided in mortar to retard curing and provide up to 36 hours of workability, as long as the admixture does not adversely affect bonding or compressive strength.

2.3 MASONRY ACCESSORIES

UNIT MASONRY

04200-3

2.3.1 Horizontal Joint Reinforcement

Fabricate from cold drawn steel wire, ASTM A 82. Wire shall be hot-dipped galvanized after fabrication in accordance with ASTM A 153 Class B-2, 1.5 oz. of zinc per square foot. Reinforcement shall be truss type with two or more longitudinal wires welded to a continuous diagonal cross wire, or ladder type with perpendicular cross wires not more than 16 inches o.c. Provide flat sections 10 feet long, and pre-formed corners and tees approximately 30 inches long. Overall width shall be approximately 2-inches less than nominal thickness of wall.

a. Single-Wythe

For single-wythe walls and partitions, provide two 9-gage (0.1483-inch) longitudinal wires and 9-gage cross wires.

2.3.2 Fastenings

Build in bolts, metal wall plugs, and other metal fastenings furnished under other sections for securing furring and other items.

2.3.3 Reinforcing Bars

ASTM A 615

2.3.4 Through-Wall Flashing

Provide one of the following types

a. Coated-Copper Flashing

7-ounce electrolytic copper sheet, uniformly coated on both sides with acid-proof, alkali-proof, elastic bituminous compound. Factory apply coating to a weight of not less than 6 ounces per square foot (approximately 3 ounces per square foot on each side).

b. Copper or Stainless Steel Flashing

Copper, ASTM B 370, minimum 16-ounce weight; stainless steel, ASTM A 167, Type 301, 302, 304, or 316, 0.010-inch thick, No. 2D finish. Provide with factory-fabricated deformations that mechanically bond flashing against horizontal movement in all directions. Deformations shall consist of dimples, diagonal corrugations, or a combination of dimples and transverse corrugations.

c. Reinforced Membrane Flashing

Polyester film core with a reinforcing fiberglass scrim bonded to one side. The membrane shall be impervious to moisture, flexible, and not affected by caustic alkalis. The material, after being exposed for not less than 1/2 hour to a temperature of 32 degrees F, shall show no cracking when, at that temperature, it is bent 180 degrees over a 1/16-inch diameter mandrel and then bent at the same point over the same size mandrel in the opposite direction 360 degrees.

PART 3 EXECUTION

3.1 PREPARATION

3.1.1 Protection

UNIT MASONRY

04200-4

a. Stains

Protect exposed surfaces from mortar and other stains. When mortar joints are tooled, remove mortar from exposed surfaces with fiber brushes and wooden paddles. Protect base of walls from splash stains by covering adjacent ground with sand, sawdust, or polyethylene.

b. Load

Do not apply uniform loads for at least 12 hours or concentrated loads for at least 72 hours after masonry is constructed.

c. Provide temporary bracing as required.

d. Polyester-Embossed Film

Provide protective boards for polyester film during job installation.

### 3.1.2 Surface Preparation

Surfaces on which masonry is to be placed shall be smooth, clean, and free of foreign substances when mortar is applied.

### 3.2 WORKMANSHIP

Carry masonry up level and plumb. Furnish and use story poles or gage rods throughout the work. Changes in coursing or bonding after the work is started will not be permitted. Do not carry one section of the walls up in advance of the others. Step back unfinished work for joining with new work. Tooling will not be permitted. Check heights of masonry at each floor and at sills and heads of openings to maintain the level of the walls. Build in door and window frames, lowered openings, anchors, pipes, ducts, and conduits as the masonry work progresses. Fill spaces around metal door frames solidly with mortar. Handle masonry units with care to avoid chipping, cracking, and spalling of faces and edges. Drilling, cutting, fitting, and patching to accommodate the work of others shall be performed by masonry mechanics. Cut masonry with masonry saws for exposed work. Structural steelwork, bolts, anchors, inserts, plugs, ties, lintels, and miscellaneous metalwork specified elsewhere shall be placed in position as the work progresses. Provide chases of approved dimensions for pipes and other purposes where indicated and where necessary. Cover tops of exposed walls and partitions not being worked on with a waterproof membrane secured in place and extended down at least 2 feet on both sides. Inspect scaffolding regularly to ensure that it is amply strong, well braced, and securely tied in position. Do not overload scaffolding.

### 3.3 MORTAR MIXING

Measure mortar materials in 1 cu. ft. containers to maintain control and accuracy of proportions. Do not measure materials with shovels. Mix mortar in a mechanical batch mixer for not less than 3 nor more than 5 minutes after all ingredients are in so as to produce a uniform mixture. Add water gradually as required to produce a workable consistency. Do not load mixer beyond its rated capacity. Keep mortar boxes, pans, and mixer drums clean and free of debris and dried mortar. Re-temper mortar which has stiffened because of evaporation by adding water and mixing to obtain a workable consistency. Do not use or re-temper mortar which has not been placed in final position within 2 1/2 hours after the initial mixing. Do not use antifreeze compounds, salts, or other substances to lower the freezing point of mortar.

a. Mortar

Mix mortar in accordance with ASTM C 270 to obtain type mortar required. When masonry cement is provided, conform to masonry cement manufacturer's printed mixing instructions.

UNIT MASONRY

04200-5

During mixing, add water-repellent admixture in quantity recommended by the admixture manufacturer to mortar which will be used in exterior concrete masonry unit walls.

b. Grout

ASTM C 476. Provide fine grout in grout spaces less than 2 inches in any horizontal dimension or in which clearance between reinforcing and masonry is less than 3/4 inch. Provide coarse grout in grout spaces 2 inches or greater in all horizontal dimensions provided the clearance between reinforcing and masonry is not less than 3/4 inch.

### 3.4 MORTAR JOINTS

Uniform thickness of 3/8-inch unless otherwise indicated. Tool exposed joints slightly concave with a round or other suitable jointer when the mortar is thumbprint hard. For horizontal joints, jointers shall be at least 12 inches long for brickwork and 16 inches long for concrete masonry. Jointers shall be slightly larger than the width of the joint so that complete contact is made along the edges of the units, compressing and sealing the surface of the joint. Strike flush joints that will not be exposed. Tool vertical joints first. Brush joints to remove all loose and excess mortar. Horizontal joints shall be level; vertical joints shall be plumb and in alignment from top to bottom of wall within a tolerance of plus or minus 1/2 inch in 40 feet.

### 3.5 TOLERANCES

Masonry work shall be within the following limits:

a. Face of Concrete Masonry Unit

1/16 inch from face of adjacent unit.

b. Variation From True Plane

1/4 inch in 10 feet and 1/2 inch maximum in 20 feet or more.

c. Variation From Plumb

1/4 inch in each story, non-cumulative and 1/2 inch maximum in two stories or more.

d. Variation From Level

1/8 inch in 3 feet, 1/4 inch in 10 feet, and 1/2 inch maximum.

e. Variation in Wall Thickness

Plus or minus 1/4 inch.

### 3.6 CONCRETE MASONRY UNIT WORK

Lay the first course in a full bed of mortar for the full width of the unit. Lay succeeding courses in running bond unless otherwise indicated. Form bed-joints by applying mortar to entire top surfaces of inner and outer face shells. Form head joints by applying mortar for a width of about 1 inch to ends of adjoining units. Mortar shall be of such thickness that it will be forced out of the joints as the units are placed in position. Where anchors, bolts, and ties occur within the cells of the units, place metal lath in the joint at the bottom of such cells and fill cells with mortar or grout as work progresses. Provide concrete brick for bonding walls, working out the coursing, topping out walls under sloping slabs, distributing concentrated loads, backing brick headers, and elsewhere as required. Do not dampen concrete masonry units before or during laying.

UNIT MASONRY

04200-6



### 3.6.1 Special Concrete Masonry Unit Work

Where exposed concrete masonry unit walls and partitions are indicated, provide special concrete masonry unit work. Select units for uniformity of size, texture, true plane, and undamaged edges and ends of exposed surfaces. Place units plumb, parallel, and with properly tooled joints of maximum 3/8-inch thickness. Keep exposed surfaces clean and free from blemishes or defects.

### 3.6.2 Reinforced Concrete Masonry Unit Walls

Where vertical reinforcement occurs, fill cores solid with grout. Lay units in such a manner as to preserve the unobstructed vertical continuity of cores to be filled. Embed the adjacent webs in mortar to prevent leakage of grout. Remove mortar fins protruding from joints before placing grout. Minimum clear dimensions of vertical cores shall be 2 by 3 inches. Position reinforcing accurately as indicated before placing grout. As masonry work progresses, secure vertical reinforcing in place at vertical intervals not to exceed 160 bar diameters. Use puddling rod or vibrator to consolidate the grout. Minimum clear distance between masonry and vertical reinforcement shall be not less than 1/2 inch. Unless indicated or specified otherwise, form splices by lapping bars not less than 40 bar diameters and wire tying them together.

### 3.7 BONDING AND ANCHORING

Unless indicated otherwise, extend partitions from the floor to the bottom of the construction above. Structurally bond or anchor walls and partitions to each other and to concrete walls, beams, and columns. Securely anchor non-load-bearing partitions and interior walls to the construction above as indicated. Completely embed anchors in mortar joints.

### 3.7.1 Corners of Load-Bearing Walls

Provide a true masonry bond in each course, except where indicated or specified otherwise.

### 3.7.2 Intersections of Load-Bearing Walls

Provide a true masonry bond in each course, or anchor with rigid steel anchors not more than 2 feet apart vertically, unless otherwise indicated.

### 3.7.3 Masonry Walls Facing or Abutting Concrete Members

Anchor masonry to concrete with dovetail or wire-type anchors inserted in slots or inserts built into concrete. Locate anchors not more than 18 inches o.c. vertically and not more than 24 inches o.c. horizontally.

### 3.8 THROUGH-WALL FLASHING

Provide as indicated. Unless indicated otherwise, extend flashing from a point 1 inch outside of exterior face of walls. Bend down exterior edge to form a drip. Flashing shall be terminated 1 inch back from interior face of walls and turned back on itself not less than 1 inch. Secure flashing as indicated. Provide flashing in lengths as long as practicable. Lap ends not less than 1½ inches for interlocking type and 4 inches for other types. Seal laps as necessary to ensure watertight construction. Provide dams at ends of flashing where masonry abuts concrete and where flashing ends within the masonry.

### 3.9 HORIZONTAL JOINT REINFORCEMENT

Provide reinforcement where indicated in walls and partitions of concrete masonry units. Reinforcement shall be continuous except at control joints and expansion joints. Reinforcement above

UNIT MASONRY

04200-7

and below openings shall extend not less than 24 inches beyond each side of openings. Provide reinforcement in the longest available lengths, utilizing the minimum number of splices. Overlap ends not less than 6 inches. Provide welded L-shaped assemblies and welded T-shaped assemblies to match straight reinforcement at corners and intersections of walls and partitions. Provide mortar cover for wire of at least 5/8 inch for exterior face of wall, ½ inch for interior face of wall.

### 3.10 CONCRETE MASONRY UNIT LINTELS AND BOND BEAMS

Provide special units, fill cells solidly with grout or concrete, and provide not less than two No. 5 reinforcing bars, unless indicated otherwise. Reinforcing shall overlap a minimum of 40 bar diameters at splices. Terminate bond beams and reinforcing on each side of expansion joints. Concrete masonry units provided for lintels and bond beams shall have exposed surfaces of the same material and texture as the adjoining masonry units. Lintels shall be straight and true and shall have at least 8 inches of bearing at each end. Allow lintels to set at least 6 days before shoring is removed. During mixing, add water-repellent admixture in quantity recommended by the admixture manufacturer to concrete and grout which will be used to fill lintels and bond beams in exterior walls.

### 3.11 CONTROL JOINTS

Provide where indicated in concrete masonry-unit walls. Provide sawed type or built-in type as required. Joints shall occur directly opposite each other on both faces of the wall and shall be filled with sealant as specified in Section 07920, "Sealants," or as indicated.

### 3.12 EXPANSION JOINTS

Fill joints with a permanently flexible pre-formed filler material and a sealant as specified in Section 07920, "Sealants."

### 3.13 GROUT PLACEMENT

Place grout from the interior side of walls, unless approved otherwise. Protect sills, ledges, offsets, and other surfaces from grout droppings. Remove grout from such surfaces immediately. Grout shall be well mixed to prevent segregation and shall be sufficiently fluid to flow into joints and around reinforcing without leaving voids. Place grout by pumping or pouring from buckets equipped with spouts in lifts not exceeding 5 feet. Keep pours at 1½ inches below top of masonry units in top course, except at finish course. Float bricks into grout to a position not less than 1 inch nor more than 2 inches from surrounding masonry units. Puddle or agitate grout thoroughly to eliminate voids. Remove masonry displaced by grouting operation and re-lay in alignment with fresh mortar.

### 3.14 FORMS AND SHORING

Construct to the shape, lines, and dimensions of members indicated. Prevent deflections which may result in cracking or other damage to supported masonry. Do not remove until members have cured.

### 3.15 CLEANING

#### 3.15.1 Protection

During cleaning operations, protect work which may be damaged, stained, or discolored.

#### 3.15.2 Pointing

Upon completion of masonry work and before cleaning, cut out defective mortar joints and tuck point joints and all holes solidly with pre-hydrated mortar.

#### 3.15.3 Cleaning

UNIT MASONRY

04200-8

Clean exposed masonry surfaces with clear water and stiff fiber brushes and rinse with clear water. Where stains, mortar, or other soil remain, continue scrubbing with warm water and detergent. Immediately after cleaning each area, rinse thoroughly with clear water. Restore damaged, stained, and discolored work to original condition or provide new work.

SECTION 05500  
METAL FABRICATIONS

PART 1 GENERAL

1.1 SUMMARY

END OF SECTION 04200

A. Section Includes:

1. Rough hardware.
2. Miscellaneous framing and supports.
3. Loose bearing and leveling plates.
4. Counters and equipment supports.
5. Miscellaneous steel trim.
6. Shelf and relieving angles.
7. Steel ladders.
8. Aluminum ladders.
9. Pipe bollards.
10. Metal bar gratings.
11. Cast-in-place stair nosings and thresholds.

B. Related Documents: The Contract Documents, as defined in Section 01010 - Summary of Work, apply to the work of this Section. Additional requirements and information necessary to complete the work of this Section may be found in other Documents.

C. Related Sections:

1. Section 03300 - Cast-in-Place Concrete: Substrate for attachments.
2. Section 04230 - Reinforced Unit Masonry: Substrate for attachments.
3. Section 05520 - Steel Handrails and Railings: Inserts and anchorage for.
4. Section 05600 - Ornamental Metal Work: Inserts and anchorage for.
5. Section 07724 - Roof Hatch: Safety ladder post.
6. Section 09900 - Painting: Metal finishes.
7. Products Furnished But Not Installed Under this Section: Inserts and anchors preset in masonry and concrete for anchorage of metal work.

1.2 DESCRIPTION OF WORK

A. The extent of metal fabrications is indicated on the Drawings, schedules and as specified

UNIT MASONRY

04200-9

METAL FABRICATIONS

05500-1

herein, and includes providing, fabricating and installing items made from iron and steel shapes, plates, bars, strips, tubes, pipes and castings which are not structural steel or other metal systems specified elsewhere herein.

B. All light iron and miscellaneous metal work not specified under another Section, but required for the work shall be provided under this Section whether or not specifically referred to herein.

### 1.3 REFERENCES

A. The publications listed below form a part of this Specification to the extent referenced. Publications are referred to in the text by basic designation only.

B. American Institute of Steel Construction (AISC):

1. Specification for Structural Steel for Buildings.

C. American National Standards Institute (ANSI):

1. ANSI B18.5 - Round Head Bolts (Inch Series).

2. ANSI B18.6.1 - Wood Screws (Inch Series).

D. American Society of Civil Engineers (ASCE):

1. ASCE / SEI 7 - Minimum Design Loads for Buildings and Other Structures.

E. American Society for Testing and Materials (ASTM):

1. ASTM A 27 / A 27M - Specification for Steel Castings, Carbon, for General Application.

2. ASTM A 47 / A 47M - Specification for Ferritic Malleable Iron Castings.

3. ASTM A 48 / A 48M - Specification for Gray Iron Castings.

4. ASTM A 36 / A 36M - Specification for Carbon Structural Steel.

5. ASTM A 53 / A 53M - Specification for Pipe, Steel, Black and Hot-Dipped, Zinc-Coated, Welded and Seamless.

6. ASTM A 123 / A 123M - Specification for Zinc (Hot-Dip Galvanized) Coatings on Iron and Steel Products.

7. ASTM A 134 - Specification for Pipe, Steel, Electric-Fusion (Arc)-Welded (Sizes NPS 16 and Over).

8. ASTM A 153 / A 153M - Specification for Zinc Coating (Hot-Dip) on Iron and Steel Hardware.

9. ASTM A 167 - Specification for Stainless and Heat-Resisting Chromium-Nickel Steel Plate, Sheet, and Strip.

10. ASTM A 176 - Specification for Stainless and Heat-Resisting Chromium Steel Plate, Sheet, and Strip.

11. ASTM A 276 - Specification for Stainless Steel Bars and Shapes.

METAL FABRICATIONS

05500-2

12. ASTM A 307 - Specification for Carbon Steel Bolts and Studs, 60,000 PSI Tensile Strength.

13. ASTM A 500 / A 500M - Specification for Cold-Formed Welded and Seamless Carbon Steel Structural Tubing in Round and Shapes.

14. ASTM A 501 - Specification for Hot-Formed Welded and Seamless Carbon Steel Structural Tubing.

15. ASTM A 568 / A 568M - Specification for Steel, Sheet, Carbon, Structural, and High-Strength, Low-Alloy, Hot-Rolled and Cold-Rolled, General Requirements for.

16. ASTM A 653 / A 653M - Specification for Steel Sheet, Zinc-Coated (Galvanized) or Zinc-Iron Alloy-Coated (Galvannealed) by the Hot-Dip Process.

17. ASTM A 780 - Practice for Repair of Damaged and Uncoated Areas of Hot-Dip Galvanized Coatings.

18. ASTM C 1107 / C 1107M - Specification for Packaged Dry, Hydraulic-Cement Grout (Nonshrink).

19. ASTM E 330 - Test Method for Structural Performance of Exterior Windows, Doors, Skylights and Curtain Walls by Uniform Static Air Pressure Difference.

20. ASTM E 935 - Test Methods for Performance of Permanent Metal Railing Systems and Rails for Buildings.

21. ASTM E 936 - Practice for Roof System Assemblies Employing Steel Deck, Preformed Roof Insulation, and Bituminous Built-Up Roofing.

F. American Welding Society (AWS):

1. AWS D1.1 / D1.1M - Structural Welding Code - Steel.

G. Americans with Disabilities Act Accessibility Guidelines (ADAAG):

1. Accessibility Guidelines for Buildings and Facilities.

H. International Code Council:

1. International Building Code (IBC), 2009.

I. National Association of Architectural Metal Manufacturers (NAAMM):

1. Metal Finishes Manual for Architectural and Metal Products.

2. MBG 531 - Metal Bar Grating Manual.

3. MBG 532 - Heavy Duty Metal Bar Grating Manual.

4. MBG 533 - Welding Specification for Fabrication of Steel, Aluminum and Stainless Steel Bar Grating.

J. SSPC: The Society for Protective Coatings (formerly Structural Steel Painting Council):

1. SSPC Painting Manual.

METAL FABRICATIONS

05500-3

2. SSPC PA 1 - Specification Procedure for Shop, Field and Maintenance Painting of Steel.
3. Paint 20 - Specification of Zinc-Rich Coating Type 1 - Inorganic and Type II - Organic.
4. SSPC SP 2 - Requirements for Hand Tool Cleaning of Steel Surfaces.
5. SSPC SP 3 - Requirements for Power Tool Cleaning of Steel Surfaces.
6. SSPC SP 6 - Standard for Commercial Blast Cleaning of Steel Surfaces.
7. SSPC SP 7 - Standard for Brush-Off Blast Cleaning of Steel Surfaces.
8. VIS 3 - Guide and Reference Photographs for Steel Surfaces Prepared by Power and Hand-Tool Cleaning.

#### 1.4 DEFINITIONS

- A. Custom Metal Fabrications: Metal fabrications custom built for a specific Project purpose.
- B. Pre-Manufactured Metal Fabrications: Metal fabrications which are factory-fabricated for a specific architectural purpose. These products may require modification to meet the Project requirements, but their primary manufactured purpose is not altered.
- C. Non-Structural/Metal Fabrications: Metal work which has not been designed by the Project Structural Engineer, and which is not part of the Structural Engineer's documents.

#### 1.5 SYSTEM PERFORMANCE

- A. Structural Performance: Provide assemblies which, when installed, comply with the following minimum requirements for structural performance, unless otherwise indicated.

#### 1.6 SUBMITTALS

- A. Section 01330 - Submittal Procedures: Procedures for submittals.
  1. Product Data: Manufacturer's specifications, anchor details and installation instructions for pre-manufactured products. Submit data indicating materials used in miscellaneous metal fabrications, including paint products and grout.
  2. Shop Drawings:
    - a. Drawings for fabrication and erection of miscellaneous metal fabrications; including plans, elevations and details of sections and connections. Show anchorage and accessory items. Provide templates for anchor and bolt installations by others.
    - b. Where materials or fabrications are required to comply with requirements for design loadings, include structural computations, materials properties and other information for structural analysis. Prepare under the seal of a professional structural engineer for products requiring structural engineering to meet the Performance Requirements.
    - c. Include profiles, sizes, connection attachments, reinforcing, anchorage, size and type of fasteners and accessories, erection drawings, elevations,

METAL FABRICATIONS 05500-4

welded connections using standard AWS welding symbols with net weld lengths.

- d. Take field measurements prior to the preparation of Shop Drawings and pre-fabrication when possible. Allow for trimming and fitting where taking of field measurements before fabrication might delay construction.

#### 3. Samples:

- a. Submit representative samples of materials and finished products as requested by the Architect.

#### 1.7 QUALITY ASSURANCE

##### A. Qualifications:

1. Fabricator: Company specializing in fabricating the products specified with a minimum of five (5) years documented experience.
2. Installer: Company experienced in performing the work of this Section with a minimum of five (5) years documented experience.

##### B. Performance Requirements:

1. Provide the capacity to withstand the following loading requirements for exterior units:
  - a. Design, fabricate and install to resist combined positive and negative windloading in accordance with IBC 2009, Section 1609 with a Vmph of 170, qs of 74.0 psf, exposure [B] [C] [D] and importance factor [1.0] [1.25] [1.5], as applicable per ASCE 7.
2. Provide assemblies which, when installed, comply with the following minimum requirements for structural performance, unless otherwise indicated.
  - a. Treads and Platforms of Steel Stairs: Capable of withstanding a uniform load of 100 pounds per square foot, or a concentrated load of 300 pounds so located as to produce maximum stress conditions.
- C. Take field measurements prior to the preparation of Shop Drawings and fabrication, where possible. Do not delay the construction. Allow for trimming and fitting when the taking of field measurements before fabrication might delay the work.
- D. Pre-assemble items in the shop to the greatest extent possible, to minimize field splicing and assembly. Disassemble units only as necessary for shipping and handling limitations. Clearly mark units for reassembly and a coordinated installation.

#### 1.8 DELIVERY, STORAGE AND HANDLING

- A. Section 01600 - Product Requirements: Transport, handle, store and protect the products.
- B. Protect materials from corrosion, deformation and other damage during delivery, storage and handling.
- C. Deliver product to the Project Site in the fabricator's original, unopened packages, containers or bundles.

METAL FABRICATIONS 05500-5

- D. Store and protect the materials with a weatherproof covering; ventilate to avoid condensation.
- PART 2 PRODUCTS**
- 2.1 MATERIALS**
- A. Use only materials which are smooth and free of surface blemishes including pitting, seam marks, roller marks, rolled trade names and roughness for fabrication of miscellaneous metalwork which will be exposed to view.
- B. Steel Plates, Angles, and Other Structural Shapes: ASTM A 36 / A 36M.
- C. Steel Pipe: ASTM A 53 / A 53M. Type and grade (if applicable), as selected by the fabricator and as required for the design loading. Black finish, unless galvanizing is indicated. Standard weight (Schedule 40), unless otherwise indicated.
- D. Galvanized Steel Pipe and Tube: ASTM A 53 / A 53M.
- E. Steel Tubing: Cold-formed, ASTM A 500 / A 500M or hot-rolled, ASTM A 501.
- F. Sheet Steel, Galvanized: ASTM A 123 / A 123M.
- G. Sheet and Strip Steel, Hot-Rolled: ASTM A 568 / A 568M.
- H. Structural Steel Sheet: Hot-rolled, ASTM A 134 or cold-rolled ASTM E 936, Class 1; of grade required for the design loading.
- I. Galvanized Structural Steel Sheet: ASTM A 653 / A 653M, of grade required for the design loading. Coating designation as indicated, or if not indicated, G90.
- J. Stainless Steel: AISI Type 304 for fumed and welded products. ASTM A 276 for base shapes and forging; ASTM A 167 or A 176 as best suited for plates, sheets and strip. Satin finish typical.
- K. Gray Iron Castings: ASTM A 48, Class 30.
- L. Malleable Iron Castings: ASTM A 47, grade as selected by the fabricator.
- M. Steel Bar Grating: ASTM A 36 / A 36M or NAAMM MBG 531.
- N. Brackets, Flanges and Anchors: Cast or formed metal of the same type material and finish as the supported fabrications.
- O. Concrete Inserts: Threaded or wedge type; galvanized ferrous castings, either malleable iron, ASTM A 47, or cast steel, ASTM A 27. Provide bolts, washers and shims, as required, hot-dip galvanized, ASTM A 153.
- P. Non-Shrink, Non-Metallic Grout: Premixed, factory-packaged, non-staining, non-corrosive, non-gaseous grout complying with ASTM C 1107 (formerly CE CRD-C621), POR-ROK Anchoring Cement by Minwax Co. division of Eastman Kodak Co., or approved equal. Comply with the manufacturer's printed instructions.
- Q. Welding Materials: AWS D1.1 / D1.1M. Type required for the materials being welded.

METAL FABRICATIONS 05500-6

**R. Anchors:**

1. Threaded Type, Concrete Inserts: Galvanized malleable iron or cast steel capable of receiving 3/4" diameter machine bolts.
  2. Slotted Type, Concrete Inserts: Welded box type, fabricated with a minimum 1/8" thick galvanized pressed steel plate with slots to receive 3/4" diameter square head bolts, and knockout cover.
  3. Expansion Shield, Masonry Anchorage: FS FF-2-325.
  4. Toggle Bolts: FS FF-B-588, type, class and style as required.
- S. Fasteners:**
1. Provide zinc-coated fasteners for exterior use or where built into exterior walls. Select fasteners for the type, grade and class required.
  2. Bolts, Nuts and Washers at Interior Locations: ASTM A 307, Grade A, regular hexagon head.
  3. Bolts, Nuts and Washers at Exterior Locations: ASTM A 307, galvanized per ASTM A 153.
  4. Bolts, Round Head: ANSI B18.5.
  5. Lag Bolts: Square head type, FS FF-B-561.
  6. Plain Washers: Round, carbon steel, FS FF-W-92.
  7. Lock Washers: Helical spring type, carbon steel, FS FF-W-84.
  8. Masonry Anchorage Devices: Expansion shields, FS FF-S-325.
  9. Toggle Bolts: Tumble-wing type, FS FF-B-588, type, class and style as required.
  10. Machine Screws: Cadmium plated steel, FS FF-S-92.
  11. Wood Screws: Flat head carbon steel, FS FF-S-111.

**T. Primers:**

1. Primer for Field Painting: Provide one of the following:
  - a. No. 99 Red Primer by Tnemec Co.
  - b. Ceco No. 15 Primox by Chessman-Elliott Company.
  - c. No. 7-C-19 by Rowe Products, Inc.
2. Touch-Up Primer for Galvanized Surfaces: High zinc dust content paint for re-galvanizing welds in galvanized steel, complying with SSPC-Paint-20 and ASTM A 780.
3. Section 01600 - Product Requirements: Product options and substitutions: Substitutions: Permitted.

METAL FABRICATIONS 05500-7

- U. Concrete Fill:
1. Concrete Materials and Properties: Comply with the requirements of Division 3 Sections for normal weight, ready-mix concrete with minimum 28-day compressive strength of 4,000 psi, 440 pounds cement per cubic yard, minimum, and a W/C ratio of 0.65, maximum, unless higher strength is indicated.
  2. Non-Slip Aggregate Finish: Factory-graded, packaged material containing fused aluminum oxide grits or crushed emery as abrasive aggregate; rust-proof and non-glazing; unaffected by moisture and cleaning materials.
- 2.2 ROUGH HARDWARE
- A. Furnish bent or otherwise custom fabricated bolts, plates, anchors, hangers, dowels and other miscellaneous steel and iron shapes as required for framing and supporting woodwork, and for anchoring or securing woodwork to concrete or other structures. Straight bolts and other stock rough hardware items are specified in Sections of Division 6.
  - B. Fabricate items to the sizes, shapes, and dimensions required. Furnish malleable-iron washers for heads and nuts which bear on wood structural connections; elsewhere, furnish steel washers.
- 2.3 MISCELLANEOUS FRAMING AND SUPPORTS
- A. General: Provide steel framing and supports for the applications indicated, or which are not a part of the structural steel framework, as required to complete the work.
- B. Fabricate miscellaneous units to the sizes, shapes, and profiles indicated or, if not indicated, of the required dimensions to receive adjacent other construction retained by framing and supports. Except as otherwise indicated, fabricate from structural steel shapes, plates, and steel bars, of welded construction using mitered joints for field connections. Cut, drill, and tap units to receive hardware, hangers, and similar items.
1. Equip units with integrally welded anchors for casting into concrete or building into masonry.
  2. Furnish inserts if units must be installed after concrete has been placed.
  3. Except as otherwise indicated, space anchors and inserts 16" o.c., and provide the minimum number of anchor units in the form of steel straps 1-1/4" wide x 8" long.
- 2.4 LOOSE BEARING AND LEVELING PLATES
- A. Provide loose bearing and leveling plates for steel items bearing on concrete or masonry construction, made flat, free from warp and twist, and of the required thickness and bearing area. Drill plates to receive anchor bolts and for grouting, as required. Galvanize after fabrication.
- 2.5 MISCELLANEOUS STEEL TRIM
- A. Provide shapes and sizes indicated for the profiles shown. Unless otherwise indicated, fabricate units from structural steel shapes, plates, and steel bars, with continuously welded joints and smooth exposed edges. Use concealed field splices wherever possible. Provide cutouts, fittings, and anchorages as required for the coordination of assembly and installation with other work.

METAL FABRICATIONS 05500-8

- B. Hot-dip galvanize miscellaneous framing and supports in exterior locations and where indicated.
- 2.6 SHELF AND RELIEVING ANGLES
- A. Provide structural steel shelf and relieving angles of the sizes indicated for attachment to concrete framing. Provide slotted holes to receive 3/4" bolts, spaced not more than 6" from the ends and at not more than 24" o.c., unless otherwise indicated.
  - B. Hot-dip galvanize shelf angles to be installed on exterior concrete framing.
  - C. Furnish wedge-type concrete inserts, complete with fasteners, for attachment of shelf and angles to cast-in-place concrete.

2.7 STEEL LADDERS

- A. Comply with OSHA, and the requirements of other agencies having jurisdiction.
- B. Fabricate ladders for the locations shown, with dimensions, spacings, details and anchorages as indicated.
- C. Wall Ladders: All steps / rungs shall be non-slip serrated treads or by coating of the rungs with aluminum oxide granules set in epoxy resin adhesive, or by using a manufactured rung filled with aluminum oxide grout. Hot-dip galvanize all ladders, brackets, and fasteners. Adhesive-applied coating strips are not acceptable.
  1. Siderails: Continuous steel flat bars, with eased edges, 1/2" x 2-1/2", 18" apart.
  2. Bar Rungs: Round steel bars, 3/4" diameter, spaced 12" o.c., unless otherwise noted.
  3. Fit rungs at the centerline of side rails, plug weld and grind smooth on the outer rail faces.
  4. Support ladders at the top and bottom, and at intermediate points spaced not more than 5'-0" o.c. by means of welded or bolted steel brackets.
  5. Size brackets to support the design dead and live loads required, and to hold the centerline of the ladder rungs clear of the wall surface by not less than 7".
- D. Provide safety post in accordance with Section 07724 - Roof Hatch.

2.8 ALUMINUM LADDERS

- A. Wall Ladders: Aluminum, all welded; standard duty channel or tube shape rails; rungs 24" wide, spaced at 12" o.c., deep serrated aluminum, carry 1,000 pounds load without deformation or failure; aluminum pipe handrails not less than 1-1/2" in diameter with end caps; mill finish; standard wall mounting brackets., OSHA / ANSI A14.3 compliant. Model 500 as manufactured by O'Keefe's Inc. or approved equal.
- B. Ship Ladder: Aluminum, all welded; standard duty channel or tube shape rails; rungs 24" wide, spaced at 12" o.c., deep serrated aluminum, carry 1,000 pounds load without deformation or failure; aluminum pipe handrails not less than 1-1/2" in diameter with end caps; mill finish; standard wall mounting brackets; incline as shown on the Drawings. OSHA / ANSI A14.3 compliant. Model 520 as manufactured by O'Keefe's Inc. or approved equal.

2.9 PIPE BOLLARDS

METAL FABRICATIONS 05500-9

- blemishes including pitting, seam marks, roller marks, roller trade names and roughness. Remove blemishes by grinding or by welding and grinding prior to cleaning, treating and the application of surface finishes, including zinc coating.
- D. Workmanship: Use materials of the size and thickness indicated or, if not indicated, as required to produce the strength and durability in the finished products for the intended use. Work to the dimensions indicated or accepted on the Shop Drawings, using proven details of fabrication and support. Use the type of materials indicated or specified.
- E. Form exposed work true to line and level with accurate angles and surfaces and straight sharp edges. Fabricate items with joints tightly fitted and secured. Make exposed joints butt tight, flush and hairline. Ease exposed edges to a radius of approximately 1/32", unless otherwise indicated. Form bent-metal corners to the smallest radius possible, without causing grain separation or otherwise impairing the work.
- F. Conceal welds where possible. Weld corners and seams continuously, complying with AWS and the Building Code. At exposed connections, grind the exposed welds smooth and flush to match and blend with the adjoining surfaces.
- G. Form exposed connections with hairline joints, flush and smooth using concealed fasteners wherever possible. Use exposed fasteners of the type indicated or, if not indicated, Phillips flat-head (countersunk) screws, or bolts.
- H. Exposed Mechanical Fastenings: Flush countersunk screws and bolts, unobtrusively located, except where specifically noted otherwise; consistent with the design.
- I. Provide anchorage of the type indicated, coordinated with the supporting structure. Fabricate and space anchoring devices to provide adequate support for the intended use. Fabricate anchorage and related components of the same material and finish as the metal fabrication, unless indicated otherwise.
- J. Cut, reinforce, drill and tap miscellaneous metal work, as indicated, to receive the finish hardware and similar items.
- K. Fabricate joints which will be exposed to weather in a manner to exclude water, or provide weep holes where water may accumulate.
- L. Galvanizing: For items indicated to be galvanized, apply zinc-coating by the hot-dip process in compliance with the following requirements:
1. ASTM A 153 / A 153M for galvanizing iron and steel hardware.
  2. ASTM A 123 / A 123M for galvanizing both fabricated and un-fabricated iron and steel products made of un-coated rolled, pressed, and forged shapes, plates, bars, and strip 0.0299" thick and heavier.
  3. ASTM A 123 / A 123M for galvanizing assembled steel products.
- 2.13 FINISHES, GENERAL
- A. Comply with NAAMM, Metal Finishes Manual for Architectural and Metal Products, for recommendations relative to the application and designation of finishes.
- B. Finish metal fabrications after assembly.
- 2.14 SHOP PAINTING AND PROTECTIVE COATING
- METAL FABRICATIONS 05500-11
- A. Fabricate pipe bollards from Schedule 80 galvanized steel pipe.
- B. Fabricate sleeves for bollard anchorage from galvanized steel pipe with 1/4" thick steel plate welded to the bottom of the sleeve.
- 2.10 METAL BAR GRATINGS
- A. Provide close mesh bar gratings using bars of the type, material, sizes, spacing and construction indicated, or if not indicated, to support the truck loadings indicated. Comply with the Standard Specifications for Metal Bar Grating and Metal Bar Grating Treads® portion of the NAAMM, Metal Bar Grating Manual®.
- B. Material: Steel.
- C. Type Grating: Welded.
- D. Bearing Bars: Size and shape as required by the anticipated loading.
- E. Cross Bars: Rectangular. Provide true alignment and equal spacing of the cross bars by notching the bearing bars prior to welding. Do not notch the bearing bars at supports to maintain elevation.
- F. Traffic Surface: Plain.
- G. Edge Band openings in the grating which interrupt four or more bearing bars with bars of the same size and material as the bearing bars.
- H. Steel Finish: Hot-dip galvanized with a coating of not less than 1.5 oz. per square foot of coated surface.
- 2.11 METAL STAIR NOSINGS
- A. Material: Cast aluminum with hatched aluminum abrasive surface, 1/4" nosing lip x 3" minimum depth, embedded; one piece the full width of stair treads and landings.
- B. Manufacturers:
1. DSA3 by American Safety Technologies.
  2. Style 3511 by American Safety Tread Co.
  3. Type 231 by Wooster Products Inc.
  4. Section 01600 - Product Requirements: Product options and substitutions: Substitutions: Permitted.
- 2.12 FABRICATION
- A. Fabricate steel items according to the approved Shop Drawings and to the applicable portions of ANSC Specifications.
- B. Pre-assemble products in the shop to the greatest extent possible. Disassemble units only as necessary for shipping and handling limitations. Clearly mark units for re-assemble and installation.
- C. For fabrications exposed to view, use materials which are smooth and free of surface
- METAL FABRICATIONS 05500-10

- A. Conform to SSPC-PA 1, including preparation for painting.
- B. Apply shop primer to un-coated surfaces of metal fabrications, except those with a galvanized finish or to be embedded in concrete, masonry, or sprayed-on fireproofing, unless otherwise indicated. Comply with the requirements of SSPC-PA 1, A Paint Application Standards, Guides and Specifications No. 1\*, for shop painting.
- C. Preparation for Shop Priming: Prepare un-coated ferrous metal surfaces to comply with the minimum requirements indicated below for SSPC surface preparation specifications and the environmental exposure conditions of the installed metal fabrications:
1. Interiors (SSPC Zone 1A): SSPC-VIS 3.
  2. Exteriors (SSPC Zone 1B): SSPC-SP 6.
- D. Shop primer for Ferrous Metal: Fast-curing, lead-free, abrasion-resistant, rust-inhibitive primer selected for compatibility with the substrates and with the types of alkyd-type paint systems indicated, and for compatibility to provide a sound foundation for field-applied topcoats, despite prolonged exposure; complying with the performance requirements of FS TT-P-86, Types I, II and III.
- E. Hot-Dip galvanizing and zinc coatings applied on products fabricated from rolled, pressed, and forged steel shapes, plates, bars and strips shall comply with ASTM A 123 / A 123M. Galvanized surfaces, for which a shop coat of paint is specified, shall be chemically treated to provide a bond for the paint. Except for bolts and nuts, all galvanizing shall be done after fabrication.
- F. Clean surfaces of rust, scale, grease and foreign matter in accordance with SSPC-SP 1 Solvent Cleaning, prior to finishing. Prepare surfaces for painting in accordance with SSPC-SP 2, SSPC-VIS 3 or SSPC-SP 7.
- G. Do not prime surfaces that will be in direct contact with concrete, or where field welding is required.
- H. Prime paint items scheduled, with one coat.
- PART 3EXECUTION**
- 3.1 EXAMINATION
- A. Section 01700 - Execution Requirements: Verification of existing conditions before starting the work.
- B. Verification of Conditions: Verify that field measurements, surfaces, substrates and conditions are as required, and ready to receive the work.
- C. Report in writing, prevailing conditions that will adversely affect satisfactory execution of the work of this Section. Do not proceed with the work until the unsatisfactory conditions have been corrected.
- 3.2 PREPARATION
- A. Coordinate and furnish anchorages, setting drawings, diagrams, templates, instructions, and directions for the installation of anchorages, such as concrete inserts, sleeves, anchor bolts, and miscellaneous items having integral anchors to be embedded in concrete or masonry.

METAL FABRICATIONS 05500-12

- B. Coordinate the delivery of such items to the Project Site.
- 3.3 INSTALLATION**
- A. Fastening to In-Place Construction: Provide anchorage devices and fasteners, where necessary, for securing miscellaneous metal fabrications to in-place construction, including threaded fasteners for concrete and masonry inserts, toggle bolts, through-bolts, lag bolts, wood screws, and other connectors, as required.
- B. Cutting, Fitting, and Placement: Perform cutting, drilling, and fitting required for the installation of miscellaneous metal fabrications. Set fabrications accurately in location, alignment, and elevation with edges and surfaces level, plumb, true, and free of rack; measured from established lines and levels.
- C. Setting Loose Plates: Clean concrete or masonry bearing surfaces of any bond-reducing materials, and roughen to improve bond to the surfaces. Clean the bottom surface of bearing plates.
- D. Set loose leveling and bearing plates on wedges, or other adjustable devices. After the bearing members have been positioned an plumbed, tighten the anchor bolts. Do not remove the wedges or shims, but if protruding, cut-off flush with the edge of the bearing plate before packing with grout. Use metallic non-shrink grout in concealed locations where not exposed to moisture; use non-metallic, non-shrink grout in exposed locations, unless otherwise indicated. Pack grout solidly between bearing surfaces and plates to ensure that no voids remain.
- E. Provide temporary bracing or anchors in the formwork for items to be built into concrete, masonry or similar construction.
- F. Fit exposed connections accurately together to form hairline joints. Weld connections that are not to be left as exposed joints, but cannot be shop welded because of shipping size limitations. Grind exposed joints smooth and touch-up shop paint coat. Do not weld, cut or abrade the surfaces of exterior units which have been hot-dip galvanized after fabrication, and are intended for bolted or screwed field connections.
- G. Bollards:
1. Anchor bollards in concrete by means of pipe sleeves preset and anchored into a concrete footing. After bollards have been inserted into sleeves, fill the annular space between the bollard and the sleeve solid with non-shrink, non-metallic grout, mixed and placed to comply with the grout manufacturer's directions.
  2. Fill bollards with concrete and round off the top.
- H. Metal Bar Gratings:
1. Comply with the recommendations of NAAMM, Metal Bar Gratings Manual® for the installation of gratings, including installation clearances and standard anchoring details.
  2. Secure removable units to supporting members with the type and size clips and fasteners indicated, of if not indicated, as recommended by the grating manufacturer for the type of installation conditions shown.
  3. Secure non-removable units to supporting members by welding where both materials are the same, otherwise fasten by bolting, as indicated.

METAL FABRICATIONS 05500-13



I. Field Welding: Comply with the AWS Code for procedures of manual shielded metal-arc welding, appearance and quality of the welds made and methods used in correcting welding work, and the following:

END OF SECTION

1. Use materials and methods that minimize distortion and develop strength and corrosion-resistance of the base metal.
  2. Obtain fusion without undercut or overlap.
  3. Remove welding flux immediately.
  4. At exposed connections, finish exposed welds and surfaces smooth and blended so no roughness shows after finishing and the contour of the welded surface matches the adjacent surfaces.
- J. Touch-Up For Galvanized Surfaces: Clean the welds, bolted connections and abraded areas, and apply two (2) coats of galvanizing repair paint in compliance with SSPC Paint 20 and ASTM A 780.
- K. Touch-Up Painting: Immediately after erection, clean field welds, bolted connections, and abraded areas of shop paint, and paint exposed areas with the same material as used for shop painting; comply with SSPC-PA 1 requirements for touch-up of field painted surfaces.
1. Apply by brush or spray and provide a minimum dry film thickness of 2.0 mils.

#### 3.4. ISOLATION REQUIREMENTS

A. Dissimilar Metals:

1. Where metal surfaces are in contact with, or fastened to dissimilar metals except stainless steel, zinc or zinc coating, the metal shall be protected from the dissimilar metal.
  2. Where drainage from a dissimilar metal passes over the metal, paint the dissimilar metal with a non-lead pigmented paint.
- B. Cementitious Materials: Paint metal where in contact with mortar, concrete, masonry or other cementitious material, with an alkali-resistant coating such as heavy-bodied bituminous paint or epoxy paint.

C. Wood Contact: Isolate metal from cedar, redwood, oak and acid-treated lumber by means of unbroken 6-mil polyethylene construction sheet or a heavy coating of metal-protective paint.

D. Surfaces in contact with sealants after installation need not be coated with any type of protective material.

#### 3.5 FIELD QUALITY CONTROL

- A. Section 01450 - Quality Control: Field inspection.
- B. Inspect fabrications and installations for alignment, attachment to the structure, and secure and rigid installation.

#### 3.6 ADJUSTING AND CLEANING

- A. Section 01700 - Execution Requirements: Adjusting the installed work.

METAL FABRICATIONS

05500-14

METAL FABRICATIONS

05500-15

SECTION 05520

STEEL HANDRAILS AND GUARDS

PART 1 GENERAL

1.1 SUMMARY

A. Section Includes:

1. Steel handrails and guards.
2. Stainless guardrails.

B. Related Documents: The Contract Documents, as defined in Section 01010 - Summary of Work, apply to the work of this Section. Additional requirements and information necessary to complete the work of this Section may be found in other Documents.

C. Related Sections:

1. Section 03300 - Cast-in-Place Concrete: Substrate for anchoring handrails and guards.
2. Section 04230 - Reinforced Unit Masonry: Substrate for anchoring handrails and guards.
3. Section 05500 - Metal Fabrications: Inserts and anchors for handrails and guards.
4. Section 09900 - Painting: Finishing of handrails and guards.

D. Products Furnished By But Not Installed Under this Section: Inserts and anchors preset in concrete and masonry for anchorage.

1.2 DESCRIPTION OF WORK

A. The extent of handrails and guards work is indicated on the Drawings and as specified herein, and includes providing, fabricating and installing miscellaneous steel handrails and guards not included in other Sections of these Specifications.

B. Handrails and guards shall comply with the applicable Building Code, ADAAG, and other Codes and standards which apply to this work of this Section.

1.3 REFERENCES

A. The publications listed below form a part of this Specification to the extent referenced. Publications are referred to in the text by basic designation only.

B. American Institute of Steel Construction (AISC):

1. Specification for Structural Steel for Buildings.

C. American National Standards Institute (ANSI):

1. ANSI B18.5 - Round Head Bolts (Inch Series).

STEEL HANDRAILS AND GUARDS 05520-1

2. ANSI B18.6.1 - Wood Screws (Inch Series).

D. American Society for Testing and Materials (ASTM):

1. ASTM A 36 / A 36M - Specification for Carbon Structural Steel.
2. ASTM A 53 / A 53M - Specification for Pipe, Steel, Black and Hot-Dipped, Zinc-Coated, Welded and Seamless.
3. ASTM A 123 / A 123M - Specification for Zinc (Hot-Dip Galvanized) Coatings on Iron and Steel Products.
4. ASTM A 136 - Specification for Pipe, Steel, Electric-Fusion (ARC)-Welded (Sizes NPS 16 and Over).
5. ASTM A 153 / A 153M - Specification for Zinc Coating (Hot-Dip) on Iron and Steel Hardware.
6. ASTM A 167 - Specification for Stainless and Heat-Resisting Chromium-Nickel Steel Plate, Sheet and Strip.
7. ASTM A 176 - Specification for Stainless and Heat-Resisting Chromium Steel Plate, Sheet and Strip.
8. ASTM A 276 - Specification for Stainless Steel Bars and Shapes.
9. ASTM A 500 / A 500M - Specification for Cold-formed Welded and Seamless Carbon Steel Structural Tubing in Rounds and Shapes.
10. ASTM A 501 - Specification for Hot-Formed Welded and Seamless Carbon Steel Structural Tubing.
11. ASTM A 568 / A 568M - Specification for Steel Sheet, Carbon, Structural, and High-Strength, Low-Alloy, Hot-Rolled and Cold-Rolled, General Requirements for.
12. ASTM A 780 - Practice for Repair of Damaged and Uncoated Areas of Hot-Dip Galvanized Coatings.

13. ASTM C 1107 - Specification for Dry, Hydraulic-Cement Grout (Nonshrink).

E. American Welding Society (AWS):

1. AWS D1.1 / D1.1M - Structural Welding Code - Steel.

F. Americans with Disabilities Act Accessibility Guidelines (ADAAG):

1. Accessibility Guidelines for Buildings and Facilities.

G. International Code Council:

1. International Building Code (IBC), 2009.

H. SSPC: The Society for Protective Coatings (formerly Structural Steel Painting Council):

1. SSPC Painting Manual.
2. SSPC-PA 1 - Shop, Field, and Maintenance Painting of Steel.

STEEL HANDRAILS AND GUARDS 05520-2

1.4 SUBMITTALS

- A. Section 01330 - Submittal Procedures: Procedures for submittals.
1. Product Data: Submit manufacturer's product specifications and installation instructions for the products and processes used in handrails and guards, including grouting and finishing.
  2. Shop Drawings: Submit for fabrication and erection of handrails and guards, including plans, elevations and details of fittings, connections, joining methods, sizes and shapes, anchorage, and relationship to other work. Provide templates for anchors and bolts installation by others.
  3. Samples: Submit for each type of metal finish indicated. Prepare samples on metal of the same gage and alloy to be used in the work. Include 6" long samples of stainless steel railing members including handrails, top rails, posts, and rail coverings, if any. Include samples of fittings and brackets.
  4. Assurance / Control Submittals:
    - a. Manufacturer's certificate that the product meet or exceed the specified requirements.
    - b. Calculations indicating that the system and anchorage satisfies the performance requirements.
    - c. Documentation of experience indicating compliance with the specified qualifications requirements.

1.5 QUALITY ASSURANCE

- A. Qualifications:
1. Manufacturer: Company specializing in manufacturing the products specified with a minimum of five (5) years documented experience.
  2. Installer: Company experienced in performing the work of this Section with a minimum of five (5) years documented experience.
- B. Performance Requirements: Handrails and guards shall be designed, fabricated and installed to meet the structural loading conditions below, unless otherwise indicated:
1. Handrails and guards shall be designed to resist a load of 50 pounds per linear foot applied in any direction at the top and to transfer the load through the supports to the structure.
  2. Handrails and guards shall be able to resist a single concentrated load of 200 pounds, applied in any direction, at any point along the top, and to transfer the load through the supports to the structure. This load need not be assumed to act concurrently with the loads specified above.
  3. Intermediate rails (all those except the handrail), balusters and panel fillers shall be designed to withstand a horizontally applied normal load of 50 pounds on an area equal to 1 square foot, including openings and space between rails. Reactions due to this loading are not required to be superimposed with those of the above loads.

STEEL HANDRAILS AND GUARDS 05520-3

- C. Engineering of each handrail and guard assembly is the responsibility of the manufacturer of the assembly.
- D. Shop Assembly: Preassemble items in the shop to greatest extent possible to minimize field splicing and assembly. Disassemble units only, as necessary, for shipping and handling limitations. Clearly mark the units for reassembly and coordinated installation.

1.6 DELIVERY, STORAGE AND HANDLING

- A. Section 01600 - Product Requirements: Transport, handle, store and protect the products.
- B. Protect the materials from corrosion, deformation and other damage during delivery, storage and handling.
- C. Deliver products to the Project Site in the fabricator's original, unopened packages, containers or bundles.
- D. Store and protect the materials with a weatherproof covering; ventilate to avoid condensation.

PART 2 PRODUCTS

2.1 MATERIALS

- A. General: Comply with the standards indicated for shapes and types of metals indicated, or required for the handrail and guards components. For fabrication of miscellaneous metal work which will be exposed to view, use only materials which are smooth and free of surface blemishes including pitting, seam marks, roller marks, rolled trade names and roughness.
- B. Steel:
1. Steel Plates, Shapes and Bars: ASTM A 36.
  2. Steel Tubing: Cold-formed, ASTM A 500; or hot-rolled, ASTM A 501.
  3. Structural Steel Sheet: Hot-rolled and cold-rolled ASTM A 568 / A 568M, Class 1; of the grade required for the design loading.
  4. Steel Pipe: ASTM A 53; type and grade as selected by the manufacturer, and as required for the design loading; black finish unless galvanizing is indicated; standard weight (Schedule 40).
  5. Stainless Steel: AISC, Type 304 for fumed and welded products; ASTM A 276 for base shapes and forging; ASTM A 167 or A 176, as best suited for plates sheets and strip. Satin finish typical.
  6. Brackets, Flanges and Anchors: Cast or formed metal of the same type material and finish as the supported rails.
- C. Non-Shrink, Non-Metallic Grout: Pre-mixed, factory-packaged, non-staining, non-corrosive, non-gaseous, complying with ASTM C 1107 (formerly CE CRD-C621). Provide grout specifically recommended by the manufacturer for interior and exterior applications of the type specified in this Section.
- D. Welding Electrodes and Filler Metal: Provide the type and alloy of filler metal and

STEEL HANDRAILS AND GUARDS 05520-4

electrodes recommended by the producer of the metal to be welded, and as required for color match, strength and compatibility in fabricated items.

- E. Fasteners: Use fasteners of the same basic metal as the fastened metal. Do not use metals which are corrosive or incompatible with the materials joined.
- F. Provide concealed fasteners for the interconnection of handrail and guard components, and for their attachment to other work.
  - 1. Provide Phillips flat-head machine screws for exposed fasteners.
- G. Anchors and Inserts: Provide anchors of the proper type, size, and material for the type of loading and installation condition shown, as recommended by the manufacturer, unless otherwise indicated. Use stainless steel anchors and inserts. Use lead expansion shield devices for drilled-in anchors. Furnish inserts required to be set into concrete and masonry work.

## 2.2 FABRICATION

- A. General: Fabricate handrails and guards to the design, dimensions and details shown.
  - 1. Provide handrail and guard members in the sizes, profiles and wall thickness indicated, with supporting posts and brackets of the size and spacing shown, but not less than required to support the design loads indicated.
  - 2. The gripping portion of handrails with a circular cross section shall be as shown on the Drawings, but shall have an outside diameter of at least 1-1/4" but not greater than 2".
  - 3. Handrails shall return to a wall, guard or the walking surface or shall be continuous to the handrail of an adjacent stair flight or ramp run.
  - 4. Handrails shall extend horizontally at least 12" beyond the top riser and continue to slope for the depth of one tread beyond the bottom riser.
  - 5. At ramps where the handrails are not continuous between runs, handrails shall extend horizontally above landings 12" minimum beyond the top and bottom of ramp runs.
  - 6. Handrail extensions shall be in the same direction of stair flights at stairways and ramp runs at ramps.
  - 7. Comply with ADAAG for additional extension requirements.
- B. Steel Fabrication: Form exposed connections with hairline joints, flush and smooth. Weld corners and seams continuously, complying with AWS recommendations. At exposed connections, grind welds smooth and flush to match and blend with the adjoining surfaces.
  - 1. Join steel handrail and guard members by butt-welding or welding with internal connectors, at the fabricator's option. At tee and cross intersections, provide coped joints.
  - 2. At bends, join pipes by means of prefabricated elbow fittings or flush radius bends, of the radiuses indicated. Form bends by the use of prefabricated elbow fittings and radius bends, or by bending the pipe at the fabricator's option. Form simple and compound curves by bending pipe in jigs to produce a uniform curvature. Maintain the cylindrical cross section of the pipe throughout the entire bend without

- 3. Close exposed ends of pipes by welding 3/16" thick steel plate in place, or by the use of prefabricated fittings.
- 4. Provide wall returns at the ends of wall-mounted handrails.

- A. Brackets, Flanges, Fittings and Anchors: Provide the manufacturer's standard brackets, flanges, end closures, miscellaneous fittings and anchors for the connection of handrail and guard members to other work. Furnish inserts and other anchorage devices for connecting handrails and guards to concrete and masonry. Fabricate and space anchorage devices with the supporting structure.
- C. Toe Boards: Where indicated, provide toe boards at guards around openings and the edge of open-sided floors and platforms. Fabricate to the dimensions and details indicated, or if not indicated, use a 4" high x 1/8" plate welded to, and centered between, each guard post.
- G. Weeps: For exterior exposed units, fabricate joints which will be exposed to weather, to exclude water, or provide weep holes where water may accumulate.

## 2.3 FINISHES

- A. Steel Finish: Paint finish per Section 09500 - Painting for galvanized and plain steel. Apply shop primer to the surfaces of metal fabrications, except those which are galvanized, or as indicated to be embedded in concrete or masonry, and in compliance with the requirements of SSPC-PA 1 for shop painting. Apply an extra coat at exposed welds.

## PART 3 EXECUTION

### 3.1 EXAMINATION

- A. Section -01700 - Execution Requirements: Verification of existing conditions before starting the work.
- B. Verification of Conditions: Verify that field measurements, surfaces, substrates and conditions are as required, and ready to receive the work.
- C. Report, in writing, prevailing conditions that will adversely affect satisfactory execution of the work of this Section. Do not proceed with the work until the unsatisfactory conditions have been corrected.

### 3.2 PREPARATION

- A. Coordinate setting drawings, diagrams, templates, instructions, and directions for installation of anchorages, such as sleeves, concrete inserts, anchor bolts and miscellaneous items having integral anchors, which are to be embedded in concrete or masonry. Coordinate the delivery of such items to the Project Site.

- B. Field Measurements: Take field measurements prior to the preparation of Shop Drawings and fabrication, where possible. Do not delay job progress. Allow for adjustments during installation where the taking of field measurements before fabrication might delay the work.

### 3.3 INSTALLATION

- A. Fit exposed connections accurately together to form tight, hairline joints.

STEEL HANDRAILS AND GUARDS 05520-5

STEEL HANDRAILS AND GUARDS 05520-6

- B. Perform cutting, drilling and fitting required for the installation of handrails and guards. Set work accurately in location, alignment and elevation, plumb, level, true to line and free of rack, measured from established lines and levels. Do not weld, cut or abrade surfaces of handrail and guard components which have been coated or finished after fabrication, and are intended for field connection by mechanical means without further cutting or fitting.
- C. Corrosion Protection: Paint metal surfaces where in contact with mortar, concrete or other masonry materials with alkali-resistant coatings such as heavy-bodied bituminous paint or epoxy paint.
- D. Adjust handrails and guards prior to anchoring to ensure matching alignment at abutting joints. Space posts at the interval indicated, or if not indicated, as required by the design loadings.
- E. Plumb posts in each direction. Secure posts and railing ends as follows:
  1. Anchor posts in concrete by means of sleeves pre-set and anchored into concrete. After posts have been inserted into sleeves, fill the space between the posts and sleeves solid with non-shrink, non-metallic grout, mixed and placed to comply with the grout manufacturer's instructions.
  2. Leave anchorage joint exposed; wipe off excess grout and leave 1/8" build-up sloped away from the posts. For installations exposed on the exterior or to the flow of water, seal the grout to comply with the grout manufacturer's directions.
  3. Anchor posts to metal surfaces with the manufacturer's standard fittings designed for the purpose.
- F. Anchoring Guard Ends:
  1. Anchor guards into concrete or masonry with the manufacturer's standard fittings designed for the purpose.
  2. Anchor guards to metal surfaces with the manufacturer's standard fittings using concealed fasteners.
- H. Attachment of Handrails and Guards to Walls:
  1. Secure handrails and guards to walls with the manufacturer's standard wall brackets and end fittings. Provide brackets with 1-1/2" clearance between the wall and the inside face of handrails. Locate brackets as indicated or, if not indicated, at spacings required by the design loading.
  2. Secure wall brackets and wall return fitting as follows:
    - a. Use the type of bracket with flanges tapped for concealed anchorage to threaded hanger bolts.
    - b. For concrete and solid masonry anchorage, use drilled-in expansion shields and concealed hanger bolts.
    - c. For hollow masonry anchorage, use toggle bolts with square heads.
    - d. For stud partitions anchorage, use lag bolts fastened to treated wood blocking between studs. Coordinate with the stud spacing for the accurate location of blocking members.

STEEL HANDRAILS AND GUARDS 05520-7

- 3.4. ISOLATION REQUIREMENTS
  - A. Dissimilar Metals: Where metal surfaces are in contact with, or fastened to dissimilar metals except stainless steel, zinc or zinc coating, the metal shall be protected from the dissimilar metal. Where drainage from a dissimilar metal passes over the metal, paint the dissimilar metal with a non-lead pigmented paint.
  - B. Cementitious Materials: Paint metal where in contact with mortar, concrete, masonry or other cementitious material, with an alkali-resistant coating such as heavy-bodied bituminous paint or epoxy paint.
  - C. Wood Contact: Isolate metal from cedar, redwood, oak and acid-treated lumber by means of unbroken 6-mil polyethylene construction sheet or a heavy coating of metal-protective paint.
  - D. Surfaces in contact with sealants after installation need not be coated with any type of protective material.
- 3.5. CONSTRUCTION
  - A. Site Tolerances:
    1. Maximum Variation from Plumb: 1/4".
    2. Maximum Offset From True Alignment: 1/4".
    3. Maximum Out-of-Position: 1/4".
- 3.6. ADJUSTING
  - A. Section 01700 - Execution Requirements: Adjusting the installed work.
  - B. Remove protective covering at completion of the Project, or when directed by the Owner's representative.
  - C. Restore finishes damaged during installation and construction so no evidence of the corrective work is noticeable.
  - D. Return items which cannot be refinished in the field to the shop, make the required alterations and refinish the entire unit, or provide a new unit.
- 3.7. FIELD QUALITY CONTROL
  - A. Section 01450 - Quality Control: Field inspection.
  - B. Inspect installations for accurate location, alignment, elevation, plumb, level, true and free of rack.
- 3.8. PROTECTION
  - A. Protect finishes of handrails and guards from damage during construction by use of temporary protective coverings, approved by guard manufacturer.

END OF SECTION

STEEL HANDRAILS AND GUARDS 05520-8

SECTION 05720

ALUMINUM HANDRAILS AND GUARDS

PART 1 GENERAL

1.1 SUMMARY

- A. Section Includes:
  - 1. Aluminum handrails.
  - 2. Aluminum guardrails.
- B. Related Documents: The Contract Documents, as defined in Section 01010 - Summary of Work, apply to the work of this Section. Additional requirements and information necessary to complete the work of this Section may be found in other Documents.
- C. Related Sections:
  - 1. Section 03300 - Cast-in-Place Concrete: Substrate for attachment of handrails and guards.
  - 2. Section 04230 - Concrete Unit Masonry: Substrate for attachment of handrails and guards.
- D. Products Furnished By But Not Installed Under this Section: Inserts and anchors preset in concrete and masonry for anchorage.

1.2 DESCRIPTION OF WORK

- A. The extent of handrails and guards work is indicated on the Drawings and as specified herein, and includes providing, fabricating and installing miscellaneous aluminum handrails and guards not included in other Sections of these Specifications.
- B. Handrails and guards shall comply with the Building Code, ADAAG, and other Codes and standards which apply to this work of this Section.

1.3 REFERENCES

- A. The publications listed below form a part of this Specification to the extent referenced. Publications are referred to in the text by basic designation only.
- B. The Aluminum Association, Inc. (AA):
- C. American Society for Testing and Materials (ASTM):
  - 1. ASTM B 26 / B 26M - Specification for Aluminum-Alloy Sand Castings.
  - 2. ASTM B 209 - Specification for Aluminum and Aluminum-Alloy Sheet and Plate.
  - 3. ASTM B 221 - Specification for Aluminum and Aluminum-Alloy Extruded Bars, Rods, Wire, Profiles and Tubes.
  - 4. ASTM B 429 / B 429M - Specification for Aluminum-Alloy Extruded Structural Pipe

ALUMINUM HANDRAILS AND GUARDS 05720-1

and Tube.

- 5. ASTM C 1107 - Specification for Packaged Dry, Hydraulic-Cement Grout (Nonshrink).

D. Americans with Disabilities Act Accessibility Guidelines (ADAAG):

- 1. Accessibility Guidelines for Buildings and Facilities.

E. International Code Council:

- 1. International Building Code (IBC), 2009.

1.4 SUBMITTALS

A. Section 01330 - Submittal Procedures: Procedures for submittals.

- 1. Product Data: Manufacturer's product specifications, anchor details and installation instructions for the products and processes used, including finishing and grouting.
- 2. Shop Drawings: For the fabrication and installation of handrails and guards, including plans, elevations and details of fittings, connections, joining methods, sizes and shapes, anchorage and relationship to other work. Provide templates for anchor and bolt installations by others.
- 3. Samples: For each type of metal finish indicated. Prepare samples on metal of the same gage and alloy to be used in the work. Where normal color and texture variations are to be expected, provide "range" samples showing the limits of such variations.
  - a. 6" long samples of distinctly different railing members, including handrails, toprails, posts, and rail coverings, if any.
  - b. Include samples of fittings and brackets.
- 4. Assurance / Control Submittals:
  - a. Fabricator's certificate that the products meet or exceed the specified requirements.
  - b. Calculations indicating that the system and anchorage satisfies the performance requirements.
  - c. Documentation of experience indicating compliance with the specified qualifications requirements.

1.5 QUALITY ASSURANCE

A. Qualifications:

- 1. Manufacturer: Company specializing in fabricating the products specified with a minimum of five (5) years documented experience.
  - 2. Installer: Company experienced in performing the work of this Section with a minimum of five (5) years documented experience.
- B. Performance Requirements: Handrails and guards shall be designed, fabricated and

ALUMINUM HANDRAILS AND GUARDS 05720-2

- installed to meet the structural loading conditions below, unless otherwise indicated:
1. Handrails and guards shall be designed to resist a load of 50 pounds per linear foot applied in any direction at the top and to transfer the load through the supports to the structure.
  2. Handrails and guards shall be able to resist a single concentrated load of 200 pounds, applied in any direction, at any point along the top, and to transfer the load through the supports to the structure. This load need not be assumed to act concurrently with the loads specified above.
  3. Intermediate rails (all those except the handrail), balusters and panel fillers shall be designed to withstand a horizontally applied normal load of 50 pounds on an area equal to 1 square foot, including openings and space between rails. Reactions due to this loading are not required to be superimposed with those of the above loads.
- C. Engineering: Engineering of each assembly is the responsibility of the manufacturer of the assembly.
- D. Shop Assembly: Preassemble items in shop to greatest extent possible to minimize field splicing and assembly. Disassemble units only as necessary for shipping and handling limitations. Clearly mark units for reassembly and coordinated installation.
- 1.6 DELIVERY, STORAGE AND HANDLING
- A. Section 01600 - Product Requirements: Transport, handle, store and protect the products.
- B. Protect finished aluminum surfaces with a strippable coating. Do not use adhesive papers or sprayed coatings which bond when exposed to sunlight or weather.
- C. Pack, box, ship, unload, store and protect the products in a manner to avoid abuse, damage and defacement.
- D. Deliver products to the Project Site in the manufacturer's original, unopened protective packaging.
- E. Store inside, protected from weather.
- F. Store to provide for water drainage and air circulation.
- 1.7 MAINTENANCE
- A. Section 01780 - Closeout Submittals: Procedures for closeout submittals.
- B. Provide the Owner with two (2) gallons, minimum, of touch-up paint to match the finish.

PART 2 PRODUCTS

2.1 MANUFACTURERS

- A. Subject to compliance with the Project requirements, manufacturers offering products which may be incorporated into the work include the following:
1. Newman Brothers, Inc.
  2. Poma Construction Corp.

ALUMINIUM HANDRAILS AND GUARDS 05720-3

- B. Section 01600 - Product Requirements: Product Options: Substitutions permitted.

2.2 MATERIALS

- A. Metals: Comply with the standards indicated for shapes and types of metals indicated or required for handrail and railing components.
- B. Aluminum: Alloy and Temper: Provide alloy and temper recommended by aluminum producer or finisher for type of use and finish indicated, and with not less than the strength and durability properties of the alloy and temper, designated below for each aluminum form required.
1. Extruded Bar and Shape: ASTM B 221, 6063-T6.
  2. Extruded Pipe and Tube: ASTM B 429 / B 429M, 6063-T6.
1. Plate and Sheet: ASTM B 209, 6061-T6.
2. Castings: ASTM B 26 / B 26M, 356-T6.
- C. Non-Shrink, Non-Metallic Grout: Premixed, factory-packaged, non-staining, non-corrosive, non-gaseous grout complying with ASTM C 1107 (formerly CE CRD-C6Z1). Provide grout specifically recommended by the manufacturer for interior and exterior applications of the type specified in this Section, POR-ROK Anchoring Cement by Minwax Co, division of Eastman Kodak Co., or approved equal.
- D. Welding Electrodes and Filler Metal: Provide the type and alloy of filler metal and electrodes recommended by the producer of the metal to be welded, and as required for color match, strength and compatibility in the fabricated items.
- E. Fasteners: Use fasteners of the same basic metal as the fastened metal, unless otherwise indicated. Do not use metals which are corrosive or incompatible with materials joined.
1. Provide concealed fasteners for the interconnection of handrail and railing components, and for their attachment to other work, except where otherwise indicated.
  2. Provide Phillips flat-head machine screws for exposed fasteners, unless otherwise indicated.
- F. Anchors and Inserts: Provide anchors of the proper type, size, and material for the type of loading and installation condition shown, as recommended by manufacturer, unless otherwise indicated. Use stainless steel anchors and inserts. Use lead expansion bolt devices for drilled-in anchors. Furnish inserts, as required, to be set into concrete and masonry work.

2.3 FABRICATION

A. General:

1. Fabricate handrails and guards to the design, dimensions and details shown. Provide handrail and guard members in the sizes and profiles indicated, with supporting posts and brackets of the size and spacing shown, but not less than required to support the design loads indicated.
2. The gripping portion of handrails with a circular cross section shall be as shown on

ALUMINIUM HANDRAILS AND GUARDS 05720-4

C. Powder coat.

- than 2".
- 3. Handrails shall return to a wall, guard or the walking surface or shall be continuous to the handrail of an adjacent stair flight or ramp run.
  - 4. Handrails shall extend horizontally at least 12" beyond the top riser and continue to slope for the depth of one tread beyond the bottom riser.
  - 5. At ramps where the handrails are not continuous between runs, handrails shall extend horizontally above landings 12" minimum beyond the top and bottom of ramp runs.
  - 6. Handrail extensions shall be in the same direction of stair flights at stairways and ramp runs at ramps.
  - 7. Comply with ADAAG for additional extension requirements.
- B. Non-welded Connections: Fabricate for the interconnection of members by means of the manufacturer's standard concealed mechanical fasteners and fittings, unless otherwise indicated. Fabricate members and fittings to produce flush, smooth, rigid, hairline mitered joints.
- 1. Fabricate splice joints for field connection using epoxy structural adhesive where this represents the manufacturer's standard splicing method.
- C. Welded Connections: Fabricate for the interconnection of members by concealed internal welds to eliminate surface grinding, using the manufacturer's standard system of sleeve and socket fittings.
- D. Radius Bends: Form to a uniform radius with smooth finished surfaces free from buckles and twists.
- E. Provide wall returns at the ends of wall-mounted handrails.
- F. Close exposed ends of handrail and railing members by use of the manufacturer's standard prefabricated end fittings.
- G. Brackets, Flanges, Fittings and Anchors: Provide the manufacturer's standard brackets, flanges, end closures, miscellaneous fittings and anchors for the connection of members to other work. Furnish inserts and other anchorage devices for connecting to concrete and masonry. Fabricate and space anchorage devices, as indicated and as required to provide adequate support. Coordinate anchorage devices with the supporting structure.
- H. Toe Boards: Where indicated, provide toe boards at guards around openings and the edge of open-sided floors and platforms. Fabricate to the dimensions and details indicated, or if not indicated, use a 4" high x 1/8" plate welded to, and centered between, each guard post.
- I. Weeps: For exterior exposed units, fabricate joints which will be exposed to weather so as to exclude water, or provide weep holes where water may accumulate.

#### 2.4 ALUMINUM FINISH

- A. Siliconized powder coating: Kynar or approved equal.
- B. Anodized.
  - the Drawings, but shall have an outside diameter of at least 1 -1/4" but not greater

ALUMINUM HANDRAILS AND GUARDS 05720-4

ALUMINUM HANDRAILS AND GUARDS 05720-6



D. Color as selected from manufacturer's standards.

### PART 3 EXECUTION

#### 3.1 EXAMINATION

- A. Section 01700 - Execution Requirements: Verification of existing conditions before starting the work.
- B. Verification of Conditions: Verify that field measurements, surfaces, substrates and conditions are as required, and ready to receive the work.
- C. Report, in writing, prevailing conditions that will adversely affect satisfactory execution of the work of this Section. Do not proceed with the work until the unsatisfactory conditions have been corrected.

#### 3.2 PREPARATION

- A. Coordinate setting drawings, diagrams, templates, instructions, and directions for the installation or anchorages, such as sleeves, concrete inserts, anchor bolts and miscellaneous items having integral anchors to be embedded in concrete or masonry. Coordinate the delivery of such items to the Project Site.
- B. Field Measurements: Take field measurements prior to the preparation of Shop Drawings and fabrication, where possible. Do not delay job progress. Allow for adjustments during installation where the taking of field measurements before fabrication might delay the work.

#### 3.3 INSTALLATION

- A. Fit exposed connections accurately together to form tight, hairline joints.
- B. Perform cutting, drilling and fitting required for the installation. Set work accurately in location, alignment and elevation, plumb, level, true to line and free of rack, measured from established lines and levels. Do not weld, cut or abrade surfaces of components which have been coated or finished after fabrication, and are intended for field connection by mechanical means without further cutting or fitting.
- C. Corrosion Protection: Coat concealed surfaces of aluminum, which will be in contact with grout, concrete, masonry, wood, or dissimilar metals, with a heavy coat of epoxy paint.
- D. Adjust prior to anchoring to ensure matching alignment at abutting joints. Space posts at the intervals indicated, or if not indicated, as required by the design loads.
- E. Anchoring Posts:
  1. Anchor posts by means of sleeves preset and anchored into concrete. After posts have been inserted into the sleeves, fill the space between the posts and sleeves solid with non-shrink, non-metallic grout, mixed and placed to comply with the grout manufacturer's directions.
  2. Leave anchorage joints exposed. Wipe off excess grout and leave 1/8" build-up, sloped away from the post. For installations exposed on the exterior, or to the flow of water, seal the grout in compliance with the grout manufacturer's instructions.
  3. Anchor posts to metal surfaces with the manufacturer's standard fittings designed

ALUMINUM HANDRAILS AND GUARDS 05720-6

for the purpose, unless otherwise indicated.

#### F. Railing Connections:

1. Permanently connect components together using the manufacturer's standard mechanical or adhesive jointer method and fittings, unless otherwise indicated. Use wood blocks and padding to prevent damage to members and fittings. Seal recessed holes of exposed locking screws using plastic filler, colored to match the finish of the handrails and guards.
- G. Anchoring Handrails and Guards Ends:
1. Anchor ends into concrete and masonry with the manufacturer's standard fittings designed for the purpose, unless otherwise indicated.
  2. Anchor ends to metal surfaces with the manufacturer's standard fittings using concealed fasteners, unless otherwise indicated.
- H. Attachment of Handrails and Guards to Walls:
1. Secure to walls with the manufacturer's standard wall brackets and end fittings; maintain 1-1/2" clearance between walls and the rail.
  2. For anchorage to concrete and solid masonry, use drilled-in expansion shields and concealed hanger bolts, unless otherwise indicated.
  3. For hollow masonry anchorage, use toggle bolts with square heads, unless otherwise indicated.
  4. For anchorage to stud partitions use lag bolts fastened to treated wood blocking between the studs. Coordinate with the spacing of studs for accurate location of the blocking.

#### 3.4 ISOLATION REQUIREMENTS

- A. Dissimilar Metals: Where aluminum surfaces are in contact with, or fastened to dissimilar metals except stainless steel, zinc or zinc coating, the aluminum shall be protected from the dissimilar metal. Where aluminum contacts another metal, paint the dissimilar metal with epoxy paint. Where drainage from a dissimilar metal passes over aluminum, paint the dissimilar metal with a non-lead pigmented paint.
- B. Cementitious Materials: Paint aluminum where in contact with mortar, concrete, masonry or other cementitious material, with an alkali-resistant coating such as heavy-bodied bituminous paint or epoxy paint.
- C. Wood Contact: Isolate aluminum from cedar, redwood, oak and acid-treated lumber by means of unbroken 6-mil polyethylene construction sheet or a heavy coating of metal-protective paint.
- D. Surfaces in contact with sealants after installation need not be coated with any type of protective material.

#### 3.5 CONSTRUCTION

- A. Site Tolerances:

ALUMINUM HANDRAILS AND GUARDS 05720-8

1. Maximum Variation from Plumb: 1/4".

2. Maximum Offset From True Alignment: 1/4".

3. Maximum Out-of-Position: 1/4".

3.6 ADJUSTING

A. Section 01700 - Execution Requirements: Adjusting the installed work.

B. Protect finishes of guards and handrails from damage during construction by use of temporary protective coverings approved by the railing manufacturer.

C. Remove protective covering at project completion.

D. Restore finishes damaged during installation and construction so no evidence of the corrective work remains.

E. Return items which cannot be refinished in the field to the shop, make the necessary alterations, and refinish the entire unit, or provide a new unit, as required.

3.7 FIELD QUALITY CONTROL

A. Section 01450 - Quality Control: Field inspection.

B. Inspect the installations for correct location, alignment and elevation, plumb, level, true to line, free of rack and secure attachment and anchorage.

3.8 PROTECTION

A. Protect the finishes of the handrails and guards from damage during construction by the use of temporary protective coverings approved by the manufacturer.

END OF SECTION

3. Anchor posts to metal surfaces with the manufacturer's standard fittings designed

ALUMINUM HANDRAILS AND GUARDS 05720-6

ROUGH CARPENTRY

06100-10

SECTION 06100  
ROUGH CARPENTRY

PART 1 GENERAL

1.1 SUMMARY

- A. Section Includes:
1. Framing lumber and construction.
  2. Miscellaneous wood blocking, supports and rough-in.
  3. Plywood.
  4. Moisture Barriers.
  5. Anchors and connectors.
  6. Preservative and fire-resistive treatment.
- B. Related Documents: The Contract Documents, as defined in Section 01010 - Summary of Work, apply to the work of this Section. Additional requirements and information necessary to complete the work of this Section may be found in other Documents.
- C. Related Sections:
1. Section 03100 - Concrete Formwork: Cast-in inserts and attachment substrate.
  2. Section - 03300 - Cast-In-Place Concrete: Substrate for attachment.
  3. Section - 04230 - Reinforced Unit Masonry: Substrate for attachment.
  4. Section 06200 - Finish Carpentry, Finish work to be anchored.
  5. Section 06400 - Architectural Woodwork: Finish work to be secured.
  6. Section 09110 - Non-Load Bearing Steel Framing: Substrate for attachment.
- D. Work furnished under other Sections but installed in whole, or in part under this Section:

1. Section 05500 - Metal Fabrications.
2. Section 08210 - Wood Doors.
3. Section 08710 - Door Hardware.
4. Division 10 - Applicable Sections.

1.2 DESCRIPTION OF WORK

- A. The extent of the rough carpentry work is indicated on the Drawings and as specified herein, and includes providing and installing wood framing and construction, anchors and

ALUMINUM HANDRAILS AND GUARDS 05720-8

connectors, miscellaneous blocking, supports and wood rough-in as required by the Project conditions.

1.3 REFERENCES

- A. The publications listed below form a part of this Specification to the extent referenced. Publications are referred to in the text by basic designation only.
- B. American Lumber Standards Committee (ALSC):
1. Softwood Lumber Standards.
- C. American Plywood Association (APA):
1. Grades and Standards.
- D. American Society of Civil Engineers (ASCE):
1. ASCE / SEI 7 - Minimum Design Loads for Buildings and Other Facilities.
- E. American Society for Testing and Materials (ASTM):
1. ASTM A 307 - Specification for Carbon Steel Bolts and Studs, 60,000 psi Tensile Strength.
  2. ASTM E 84 - Test Method for Surface Burning Characteristics of Building Materials.
- F. American Wood Preservers Association(AWPA):
1. AWPA - C1 - All Timber Products - Preservative Treatment by Pressure Process.
  2. AWPA - C15 - Wood for Commercial-Residential Construction Preservative Treatment by Pressure Processes.
  3. AWPA - C20 - Structural Lumber - Fire-Retardant Treatment by Pressure Processes.
  4. AWPA - C27 - Plywood - Fire-Retardant Treatment by Pressure Processes.
  5. AWPA - P5 - Water Borne Preservatives.
- G. International Code Council:
1. International Building Code (IBC):
- H. Underwriters' Laboratories, Inc. (UL):
1. UL FR S - Fire-Rated Treated Wood with Flame Spread and Smoke Developed Ratings of 25 or less in accordance with ASTM E 84.
  2. UL 723 - Test for Surface Burning Characteristics of Building Materials.

1.4 SUBMITTALS

- A. Section 01330 - Submittal Procedures: Procedures for submittals.

ROUGH CARPENTRY 06100-2

1. Shop Drawings: Dimensioned plans, elevations, sections, large scale details, attachment devices, anchors and other components.
  2. Assurance / Control Submittals:
    - a. Wood Treatment: Treatment manufacturer's instructions for the proper use of each type of treated material.
    - b. Certificates:
      - 1) Pressure Treatment and Termitte Treatment: Certification from the treating plant identifying the chemicals and process used, net amount of preservative retained; conformance with applicable standards.
      - 2) Water-borne Preservatives: Certification from the treating plant stating that the moisture content of treated materials was reduced to a maximum of fifteen percent (15%) prior to shipment to the Project Site.
      - 3) Fire Retardant Treatment: Certification from the treating plant stating that the type of chemicals used and the fire performance characteristics achieved; that the fire-retardant treatment materials comply with the governing code, ordinances and requirements of local authorities having jurisdiction; that treatment will not bleed through finished surfaces.
- 1.5 QUALITY ASSURANCE
- A. Perform work in accordance with the following agencies:
    1. Lumber Grading Agency: Certified by ALSC.
    2. Plywood Grading Agency: Certified by APA.
  - B. Regulatory Requirements: Conform to the applicable codes for fire-retardant treatment of wood surfaces for flame / smoke ratings.
  - C. Performance Requirements: For exterior uses, design, fabricate, reinforce, install and anchor to withstand the following windload requirements:
    1. Combined positive and negative windloading in accordance with IBC 2009 Section 1609 with a Vmph of 170, qs of 74.0, exposure [B][C][D], and importance factor of [1.0][1.25][1.5], as applicable per ASCE 7.
  - D. Evidence of Grade:
    1. Stamp each piece of lumber and plywood with a grade mark and trademark of the Association having jurisdiction, or accompany each shipment with an official certificate of inspection. Stamp on concealed surfaces or surfaces scheduled for opaque paint finish.
- 1.6 DELIVERY, STORAGE AND HANDLING

ROUGH CARPENTRY 06100-3

- A. Section 01600 - Product Requirements: Transport, handle, store and protect the products.
  1. Inspect wood materials for conformance with the specified grades, species and treatment at the time of delivery to the Project Site.
  2. Reject and return unsatisfactory wood materials.
- B. Provide facilities for the handling and storage of materials to prevent damage to edges, ends and surfaces.
- C. Keep materials dry. Stack materials off the ground a minimum of 12" or, if on a concrete slab-on-grade, a minimum of 1-1/2"; fully protected from the weather. Provide for air circulation within and around stacks, and under temporary coverings.
- D. For materials pressure treated with waterborne chemicals, place spacers between each bundle to provide for air circulation.

PART 2 PRODUCTS

2.1 FRAMING LUMBER

- A. General:
  1. Use Douglas Fir or Southern Pine where concealed; Redwood where exposed.
  2. Pressure and termite treated.
  3. Sizes shown are nominal. Actual sizes shall conform to American Lumber Standard, PS 20-70.
  4. Dimensioned lumber shall be S4S to standard dimensions.
  5. Moisture content shall be fifteen percent (15%) or less, unless otherwise noted.
  6. All lumber shall bear the grade mark of Western Wood Products Association (WWPA) standard grading rules, latest edition. Grades called out below are minimum. Use appearance grade where exposed to view.
- B. Non-Load Bearing, Blocking, Bridging and Miscellaneous Framing: Standard Grade, Table 1.
  - 1.
- C. Load-Bearing and Non-Load Bearing Studs (8' long or less), Related Plates and Sills: No. 2 Grade, Table 3.
- D. Load-Bearing Studs (over 8' long), Related Plates and Sills: Select No. 1 or better grade, Table 3. Knots, pitch pockets, checks, splits, or bark shall not be allowed at full length of board edges.
- E. Roof, Ceiling and Floor Joists, Purlins, Rafters, Posts: No. 1 Grade, Table 3.
- F. Load-Bearing Beams, Headers, Stair Stringers, Truss Members: Select Structural Grade, Table 3.
- G. Boards: Construction Grade.

ROUGH CARPENTRY 06100-4

2.2 NAILERS, BLOCKING, FURRING AND SLEEPERS

- A. Wood for nailers, blocking, furring and sleepers: Construction grade, finished 4 sides, 15 percent maximum moisture content. Pressure preservative treat items in contact with roofing, flashing, waterproofing, concrete, masonry or the ground.

2.3 PLYWOOD

- A. General: Grading Rules in accordance with American Plywood Association (APA), Plywood Specification & Grade Guide, 1978 edition. All plywood with pressure and termite treatment shall bear appropriate grade trademark of the APA.
- B. Wall/Roof Sheathing: 3/4", C-D 48/24; INT-APA Grade, Group 1; exterior glue, unsanded, T&G all edges - full face, 48" x 96" panels.
- C. Roof / Floor Sheathing: 1-1/8", 2-4-1, C-D, INT-APA grade, Group 1; exterior glue, unsanded, T&G all edges - full face, 48" x 96" panels.
- D. Subfloor Over Concrete: 3/4", CDX Ext Grade; exterior glue, 48" x 96" panels.
- E. Plywood Backing Plates (for mounting electrical and telephone equipment): Fire-retardant treated panels with grade designation, APA C-D PLUGGED INT; exterior glue, in thickness indicated, or if not indicated, not less than 2".

2.4 MOISTURE BARRIERS

- A. Install where shown on the Drawings or where required.
- B. Place under wood plates bearing directly on earth supported concrete slabs and at subfloors over concrete slabs.
- C. 15 pound asphalt saturated roofing felt, non-perforated.

2.5 ROUGH HARDWARE

- A. All necessary hardware for installation of the work specified herein, of the sizes and quantities required by Building Code or herein after specified. Hardware shall be hot-dip galvanized steel or approved type of non-ferrous metal.

2.6 FRAMING CONNECTORS AND ACCESSORIES

- A. Provide connectors and accessories where indicated or as required by conditions; zinc-coated steel, Code approved, as manufactured by Simpson Company, Silver Metal Products, Inc., or as approved. If a specific type is not shown, use type recommended by the connector manufacturer for the conditions of installation. Secure with nails, screws, or bolts provided or recommended by the manufacturer.

2.7 CONSTRUCTION ADHESIVE

- A. Conform to APA performance specification AFG-01 and specific application recommendations of the manufacturer.
- B. Products as manufactured by Bostik, Inc., Henkel, Sovereign Specialty Chemicals, Inc. or approved equal.

ROUGH CARPENTRY 06100-5

2.8 FASTENERS

- A. General: Hot-dip galvanized steel, typical.
1. Nails and Staples: Federal Spec FF-N-105B.
  2. Bolts: Federal Spec FF-B-575.
  3. Nuts: Federal Spec FF-N-836.
  4. Lag Screws and Bolts: Federal Spec FF-B-561.
  5. Toggle Bolts: Federal Spec FF-B-588.
  6. Wood Screws: Federal Spec FF-S-111.
  7. Expansion Shields: Federal Spec FF-S-325.

B. Fasteners:

1. Bolts, Nuts, Lag Screws, Wood Screws and Washers: ASTM A 307, medium carbon steel, size and type to suit the application, unless otherwise noted.
2. Expansion Shield Fasteners: For anchorage of non-structural items to solid concrete and masonry.
3. Powder or Pneumatically Activated Fasteners: For anchorage of non-structural items to steel.
4. Fasteners for Non-Structural Wood Members to Masonry: 1/4" diameter x 3-1/4", Phillips, flat head.

- C. Provide necessary installation of the work required; sizes and quantities of fasteners noted herein or as required by Code.

- D. Tools: Provide the manufacturers recommended power tool for installing each type of fastener.

2.9 WOOD TREATMENT

A. General:

1. Treatment material shall provide protection against termites and fungal decay and shall be approved for use as a wood preservative for its intended use by the U. S. Environmental Protection Agency.
2. For all lumber and plywood above the ground and in ground contact, comply with the applicable requirements of AWPA, Standards C2 for Lumber, C9 for Plywood and of the AWPB standards referenced below.
3. Treated material shall meet the interior Type A requirements in AWPA, Standard C-20 for lumber and C-27 for plywood.
4. Pressure treat above ground items with water-borne preservatives complying with AWPA LP-2.

ROUGH CARPENTRY 06100-6

5. After treatment, kiln dry to a maximum moisture content of fifteen percent (15%).
  6. Mark each treated item with AWPB Quality Mark Requirements.
  7. Chemicals used to treat materials shall be free of halogens, sulfates, ammonium phosphate and formaldehyde.
- B. Wood Requiring Treatment:
1. Lumber, Preservative Treated: All interior and exterior wood including nailers, blocking, stripping and similar items in conjunction with roofing, flashing and other construction: sills, blocking, furring, stripping, ledgers, supports and similar items in contact with concrete or masonry.
  2. Lumber, Fire-Retardant Treated: Interior framing, blocking, furring, stripping, ledgers, supports, nailers, and miscellaneous exposed wood. Do not use fire-treated wood in contact with concrete or masonry.
  3. Interior Plywood, Fire-Retardant Treated: Plywood backing for electrical and telephone equipment.
- C. Preservative Pressure Treated Lumber:
1. Products:
    - a. Ammoniacal Copper Zinc Arsenate (ACZA).
    - b. Chromated Copper Arsenate (CCA).
    - c. Fluor Chrome Arsenate Phenol (FCAP).
    - d. Pentachlorophenol (Penta).
  2. Comply with EPA and OSHA requirements and regulation and in accordance with AWPB, P-9. Type C treatment shall not discolor the wood used for exposed finish.
  3. Incising is not permitted for appearance grade lumber or where materials are exposed to view.
  4. Impregnate lumber with a preservative treatment conforming to AWPB, Standard C1 and P5. Apply preservative in a closed cylinder by the pressure process in accordance with AWPB, Standard C15.
  5. Retention of dry salts:
    - a. Moderate service conditions (weather exposure): 0.25 pounds per cubic foot (oxide basis).
    - b. Severe conditions (constant contact with the ground or water): 0.40 pounds per cubic foot (oxide basis).
  6. Remove excess moisture where shrinkage is a serious fault and where treated lumber will be in contact with concrete, masonry or plaster, and where water-borne treated lumber is to be painted or stained.

ROUGH CARPENTRY

06100-7

7. Lumber to be painted or stained shall have knots and pitch streaks sealed the same as for untreated wood.
  8. Liberally brush freshly cut surfaces, bolt holes and machined areas with the same preservative, in accordance with AWPB, Standard M4.
- D. Fire-Retardant Treatment:
1. Where fire-retardant lumber or plywood is specified, otherwise indicated or required by the Building Code, provide materials which comply with AWPB standards for pressure impregnation. Use fire-retardant chemicals which have a flame spread rating of not more than 25 when tested in accordance with UL Test 723 or ASTM E 84, and show no increase in flame spread and significant progressive combustion upon continuation of the test for an additional twenty (20) minutes.
  2. Where treated items are exposed at the exterior or high humidities or are to have a transparent finish, provide appearance grade materials which show no change in fire hazard classification when subjected to standard rain test UL 790 or ASTM B 2898.
  3. Use fire-retardant treatment which will not bleed through or adversely affect the type of finish indicated and which does not require brush treatment of field made cuts to maintain the fire hazard classification.
  4. Where transparent finish is indicated, use the type of treatment and species which permits milling of the lumber after treatment without altering the indicated fire hazard classification, as determined by fire testing.
  5. Kiln dry treated items to a moisture content of fifteen percent (15%), maximum.
  6. Provide UL label on each piece of fire-retardant lumber and plywood.
  7. Inspect each piece of treated lumber and plywood after drying. Discard damaged and defective pieces.
  8. Products:
    - a. "Dricot" by Arch Wood Protection.
    - b. "Pyro-Guard" by Hoover Treated Wood Products.
    - c. Section 01600 - Product Requirements: Product options and substitutions. Substitutions: Permitted.

PART 3 EXECUTION

3.1 EXAMINATION

- A. Section 01700 - Execution Requirements: Verification of existing conditions before starting the work.
- B. Verification of Conditions: Verify that field measurements, surfaces, substrates and conditions are as required, and ready to receive the work.

ROUGH CARPENTRY

06100-8

1. Verify that spacing, direction and details of supports are correct to accommodate the installation of blocking, backing, stripping, furring and nailing strips.
2. Verify that surfaces to receive work are rigid, secure, accurately sized and located and otherwise properly prepared.
- C. Report, in writing, prevailing conditions that will adversely affect satisfactory execution of the work of this Section. Do not proceed with the work until the unsatisfactory conditions have been corrected.
- 3.2 COORDINATION
- A. Fit carpentry work to other work. Scribe and cope as required for accurate fit.
- B. Coordinate the location of furring, nailers, blocking, grounds and similar supports to allow for the proper attachment of other work.
- 3.3 GENERAL
- A. Field Measurements:
1. Verify field measurements prior to fabrication.
  2. If field measurements differ slightly from Drawing dimensions, modify the work as required for accurate fit.
  3. If measurements differ substantially, notify the Owner's representative prior to fabrication.
- B. Workmanship:
1. Carefully layout, cut, fit and install rough carpentry items.
  2. Use sufficient number of nails, spikes, screws and bolts to insure rigidity and permanence.
  3. Drive nails perpendicular to the grain of wood in lieu of toenailing, where feasible.
  4. Provide for installation and support of plumbing, air conditioning and ventilation work.
  5. Install work true to lines, plumb and level, unless indicated or required otherwise.
- C. Installation:
1. Install proprietary products in accordance with the manufacturer's directions.
  2. Provide washers under nuts and heads when making bolted or lag screwed connections.
  3. Except as otherwise specified herein, machine nail or staple with written approval only.
  4. Install framing connectors where indicated; secure with fasteners recommended by the manufacturer.

ROUGH CARPENTRY

06100-9

- D. Protecting Other Work and Existing Facilities: Protect against damage and discoloration caused by the work of this Section.

3.4 PLATES

- A. Provide single plates at floors and bottoms of openings; double plates face nailed together at ceilings and heads of openings.
- B. Provide headers, as specified herein, over openings more than 2'-6" wide.
- C. Splice single plates; stagger ends of double plates at least 48"; splice plates abutting corners. Locate plate splices directly over studs.
- D. Unless shown otherwise on the Drawings, anchor plates resting on concrete or masonry with 1/2" diameter bolts at 48" o.c., maximum, or as required by windload.

3.5 JOISTS AND RAFTERS

- A. Set with crown side up; lap and spike together over bearings utilizing joist hangers proper for the application. Minimum bearings on wood or metal: 1-1/2"; on masonry: 3".
- B. Spike studs to joists resting on ribbon boards, block ends between studs where joists and studs are not in contact.
- C. Double joists under partitions running parallel to the joists; space to provide clearance for pipes in partitions.
- D. Double headers and trimmers; spike beams with ledgers to the ends of joists.

3.6 BRIDGING

- A. Cross Bridging:
1. Nominal 2" x 3" wood, or approved type metal.
  2. Provide at not more than 8 feet apart in joist spans. Do not anchor until dead loads are in place.
  3. Space cross bridging members 1/4" apart to avoid rubbing against each other.
- B. Solid Bridging:
1. Provide nominal 2" solid bridging over bearings, full depth of the joists, unless noted otherwise.

3.7 PLYWOOD SUBFLOORING

- A. Apply face grain perpendicular to and continuous over joists or sleepers with end joints on bearings; stagger end joints.
- B. Leave 1/16" space at all edge and end joints; 3/32" at T&G edges.
- C. Before panels are placed, apply a bead of construction adhesive to the joists and T&G joints with a caulking gun.

ROUGH CARPENTRY

06100-10

- D. Secure panels to joists with 8d deformed shank nails at 6" o.c. at edges and 10" o.c. at intermediate supports.
- E. Complete all nailing within the adhesive manufacturer's specified assembly time.
- F. Protect from moisture and other damage during construction.
- G. Place 15 pound asphalt roofing felt over concrete subfloors and concrete slabs with plywood, secured to the floor with 1-1/2" screws in expansion shields.
- 3.8 ROOF SHEATHING
- A. Apply face grain perpendicular to and continuous over supports with end joints on bearings; stagger end joints.
- B. Leave 1/16" space at all square edges; 1/32" at T&G joints.
- C. Secure 1-1/8" panels with 10d ring shank nails at 6" o.c. at edges and intermediate supports, unless noted otherwise.
- D. Protect from moisture and other damage until roofing is applied.
- 3.9 DOOR & WINDOW BUCKS, FRAMING BLOCKING
- A. Provide treated wood, cut to size at locations against concrete and masonry.
- B. Provide fire-retardant treated bucks and framing in fire-rated partitions.
- 3.10 SITE TREATMENT OF WOOD MATERIALS
- A. Apply preservative treatment in accordance with the manufacturer's published instructions.
- B. Brush apply two coats of preservative treatment on wood in contact with cementitious materials and roofing and related metal flashings.
- C. Treat site-sawn outs.
- D. Allow preservative to dry prior to erecting members.
- 3.11 CONSTRUCTION
- A. Site Tolerances: Framing Members: 1/4" from true position, maximum.

END OF SECTION

ROUGH CARPENTRY 06100-

SECTION 06200  
FINISH CARPENTRY

PART 1 GENERAL

1.1 SUMMARY

A. Section Includes:

1. Interior wood paneling.
  2. Wood door frames.
  3. Standing and running trim.
  4. Plastic laminate.
  5. Adjustable shelving.
- B. Related Documents: The Contract Documents, as defined in Section 01010 - Summary of Work, apply to the work of this Section. Additional requirements and information necessary to complete the work of this Section may be found in other Documents.
- C. Related Sections:
1. Section 06100 - Rough Carpentry: Blocking and backing plates for anchorage.
  2. Section 06400 - Architectural Woodwork: Cabinetry.
  3. Section 08710 - Door Hardware: Hardware for wood doors.
  4. Section 09110 - Non-Load Bearing Steel Framing: Substrate framing.
  5. Section 09900 - Painting: Finishes.

1.2 DESCRIPTION OF WORK

- A. The extent of finish carpentry work is indicated on the Drawings and as specified herein, and includes providing and installing all finish woodwork, wood trim for bases, wall rails, crown moldings, ceiling battens, wood door and window frames, jambs and moldings and wood veneer paneling as required to complete the Project.

1.3 REFERENCES

- A. The publications listed below form a part of this Specification to the extent referenced. Publications are referred to in the text by basic designation only.
- B. American National Standards Institute (ANSI):
1. ANSI A135.4 - Basic Hardboard.
  2. ANSI A208.1 - Mat Formed Wood Particleboard.
- C. Architectural Woodwork Institute (AWI):

FINISH CARPENTRY 06200-1



- 1. AWI AWQS - Architectural Woodwork Quality Standards, 8th Edition, Version 2.0.
- D. American Society for Testing and Materials (ASTM):
  - 1. ASTM E 84 - Test Method for Surface Burning Characteristics of Building Materials.
- E. Americans with Disabilities Act Accessibility Guidelines (ADAAG):
  - 1. Accessibility Guidelines for Buildings and Facilities.
  - 2. Accessibility Guidelines for Schools.
- F. National Electric Manufacturer's Association (NEMA):
  - 1. NEMA LD3 - High Pressure Decorative Laminates.
- G. United States Department of Commerce Product Standard (PS):
  - 1. PS 20 - American Softwood Lumber Standard.
- H. Western Wood Products Association (WWPA):
  - 1. WWPA - Quality Standards.

1.4 DESIGN INTENT

- A. It is the design intent that similar woodwork throughout the Project match. Coordinate work between the separate installers providing similar woodwork to ensure that the design intent is achieved to the satisfaction of the Owner's representative.

1.5 SUBMITTALS

- A. Section 01330 - Submittal Procedures: Procedures for submittals.
  - 1. Product Data: Manufacturer's specifications and installation instructions for each item of factory-fabricated paneling, wood veneer, finish hardware, anchorage devices and finish coating products.
  - 2. Shop Drawings: Show the location of each item, dimensioned plans and elevations, large scale details, attachment, anchorage and related components.
  - 3. Samples: For each species and cut or pattern of finish carpentry, label each sample according to species, grade, grain cut and finish type.
    - a. Treated Wood: 12" long sample of termite, preservative and fire-retardant treated wood items.
    - b. Interior standing and running trim: 24" long x full board or molding width, unfinished.
    - c. Factory-Finished Plywood Veneer and Wood Paneling: 24" long x panel width.
    - d. Worked (Shaped) Pieces, Unfinished: Profile size x 12" lengths. For work requiring eased edges, submit samples of each size of eased edge

FINISH CARPENTRY

06200-2

- required. Samples for each species, grade, and grain cut need not be submitted.
- e. Finished Samples: Representative board samples of 3/4" x 8-1/2" x 11" size with transparent finishes of each type, color and texture required; finished by the Paint applicator.
- f. Hardware: One (1) complete unit of each type and finish required.
- 4. Wood Treatment Data: Chemical treatment manufacturer's instructions for handling, storage, installation and finishing treated materials.
  - a. Pressure Treatment and Termite Treatment: For each type specified, include certification by the treating plant stating the chemicals and process used, net amount of preservative retained and conformance with applicable standards.
  - b. Dip Treatment: For each type specified, include certification by the treating plant stating the chemical solutions used, submersion period and conformance with applicable standards.
  - c. Fire-Retardant Treatment: Include certification by the treating plant indicating the type of chemicals used and fire performance characteristics achieved.
- 5. Assurance / Control Submittals:
  - a. Manufacturer's certification that the fabricated woodwork complies with the quality grades and other requirements indicated.
  - b. Documentation of experience indicating compliance with the specified qualifications requirements.
- B. Section 01780 - Closeout Submittals: Procedures for closeout submittals.
  - 1. Warranty: Submit a written Warranty with forms completed in the name of the Owner and registered with the manufacturer.

1.6 COORDINATION

- A. Pre-Installation Meeting: Convene a Pre-Installation Meeting at the Project Site prior to the delivery of finish carpentry materials to the Site.
  - 1. Require attendance of the Contractor, Architect, Owner's representative and representatives of the installer of architectural woodwork, other finishes, painting and related mechanical and electrical work.
  - 2. Review coordination and environmental controls required for proper installation and ambient conditions in areas to receive the work.
  - 3. Review preparation and installation procedures, and the coordination and scheduling required with related work.
- B. Support Work:
  - 1. For support work not indicated in the Contract Documents, coordinate requirements with other installers, in a timely manner.

FINISH CARPENTRY

06200-3

CENTRAL POLICE PRECINCT

2. Provide work as necessary to ensure that all work has proper framing and reinforcing supports to ensure secure and solid installations.

#### 1.7 QUALITY ASSURANCE

- A. Perform the work in accordance with AWI. Premium quality where designated, Custom quality all others
- B. Manufacturer: Company specializing in manufacturing the products specified with a minimum of five (5) years documented experience.
- C. Installer: Company experienced in performing the work of this Section with a minimum of five (5) years documented experience.

#### 1.8 DELIVERY, STORAGE AND HANDLING

- A. Section 01600 - Material and Equipment: Transport, handle, store and protect to prevent damage.
- B. Deliver products to the Project Site in the manufacturer's original, unopened packaging.
- C. Do not deliver products to the Project Site until wet work, grinding, painting and similar operations which could damage, soil or deteriorate the finish carpentry has been completed in the installation areas, and humidity has been stabilized.
- D. If, due to unforeseen circumstances, finish carpentry materials must be stored in other than installation areas, store only in areas meeting the requirements specified for the installation areas.
- E. Protect installed finish carpentry from damage and excessive relative humidity until final acceptance.

#### 1.9 JOB CONDITIONS

- A. Fabricator of the finish carpentry shall determine the optimum moisture content and the required temperature and humidity conditions.
- B. The installer shall advise the Contractor of the temperature and humidity requirements for the finish carpentry installation areas. Do not store or install finish carpentry until the required temperature and relative humidity has been stabilized and will be maintained in the installation areas.
- C. Stabilize temperature and humidity in installation areas as necessary to maintain the moisture content of the installed finish carpentry within a 1.0% tolerance of optimum moisture content, from the date of installation throughout the remainder of the construction period.

#### PART 2 PRODUCTS

##### 2.1 GENERAL

- A. Finish Carpentry Standards:
  1. Comply with AWI, Premium quality where designated, Custom quality grade for trim, jams, frames and detailing.

#### FINISH CARPENTRY

06200-4

2. Lumber shall be best grade for clear finishes.
3. Moisture content of lumber shall be no more than 13%.
4. Minimum lengths for trim and frames shall be:
  - a. One continuous piece for openings.
  - b. Joints no closer than 12 feet apart in running trim.
5. Sizes and profiles as called for on the Drawings.

##### B. Backpriming:

1. Back prime work immediately upon arrival of the units at the Project Site with a single coat of spar varnish or other acceptable sealer for fabricated units to be installed as an exterior component or where against portland cement plaster, gypsum plaster, or against exterior facing walls of concrete or masonry.
2. Ensure that the sealer does not contaminate surfaces requiring a transparent finish.

#### 2.2 MATERIALS

##### A. Millwork:

1. Wood door and window frames, trim and plywood, ceiling frames and panels, and solid paneling shall be the species and cut designated in finish schedules, drawings and details; best clear Premium quality where designated, Custom quality grade, for transparent finish; sized and fabricated as detailed.
2. Exterior wood fascia boards, [screens], [trellis frames], shall be clear, all heart Redwood.

##### B. Panels: Fiberboard or fiberboard core plywood, construction balanced.

##### C. Plywood: For exterior use and interior use exposed to moisture shall be marine grade.

##### D. Veneers: Species, cut and matching as indicated or selected, grade 1, factory-finished.

#### 2.3 WOOD TREATMENT

- A. Preservative Treatment: For all exterior and interior wood, comply with applicable requirements of AWWA, Standards C2 (Lumber), C9 (Plywood), and of AWPB, Quality Marks Requirements.

##### B. Preservative Treatment Types:

1. Ammoniacal Copper Zinc Arsenate (ACZA).
2. Pentachlorophenol (Penta).
3. Fluor Chrome Arsenate Phenol (FCAP).
- C. Pressure-treat above ground items with water-borne preservatives complying with AWPB LP-2.

#### FINISH CARPENTRY

06200-5

- D. Dip-treat interior wood.
- E. Apply in accordance with OSHA and EPA requirements and regulations and in accordance with AWP, P-3. Treatment shall not discolor finished wood exposed to view.
- F. Fire-Retardant Treatment:
1. Where fire-retardant wood is specified or required, provide materials which comply with AWP standards for pressure impregnation with fire-retardant chemicals, and which have a flame spread rating of not more than 25 when tested in accordance with UL Test 723 or ASTM E 84, and shows no increase in flame spread and significant progressive combustion upon continuation of the test for an additional twenty (20) minutes.
  2. Where treated items are exposed to the exterior or to high humidity or are to have a transparent stain or sealer finish, provide appearance grade materials which show no change in the fire-hazard classification when subjected to standard rain test in accordance with UL 790 or ASTM B 2898.
  3. Use fire-retardant treatment which will not bleed through or adversely affect the type of finish indicated, and which does not require brush treatment of field made cuts to maintain the fire-hazard classification.
- G. Products Scheduled for Transparent Finish:
1. Treatment color shall be compatible with products scheduled for a transparent finish. Provide samples of treatment with finish applied for review.
  2. Where a transparent finish is indicated, use the type of treatment and species which permits milling of the lumber after treatment without altering the indicated fire-hazard classification, as determined by fire testing.
- H. Incised Materials: Do not use incised materials where finished work will be exposed to view.
- 2.4 INTERIOR WOOD PANELING
- A. Veneer plywood for transparent finish, clear plain cut Mahogany, color and grain matched for consistency between panels and with the trim.
  - B. Stain and transparent finish.
- 2.5 WOOD DOOR FRAMES
- A. Grade:
1. Opaque Painted: AWI, Custom.
  2. Transparent: AWI, Premium.
- B. Wood: Same species as the wood door face veneer. Ease edges.
- 2.6 STANDING AND RUNNING TRIM
- A. Grade:
1. Opaque Painted: AWI, Custom.
  2. Transparent: AWI, Premium.
- B. Wood: Same species as the wood door face veneer. Ease edges.
1. Opaque Painted: AWI, Custom.
2. Transparent: AWI, Premium.
- B. Trim, boards and plywood for painted finish: Softwood suitable for the exposure and use.
- C. Trim and boards for transparent finish: Wood species as selected.
- D. Back Construction: Rout or groove the backs of flat trim members, keef backs of other wide flat members, except for members with ends exposed in finish work.
- 2.7 PLASTIC LAMINATE
- A. Manufacturers: Subject to compliance with the Project requirements, manufacturers offering products which may be incorporated into the work include the following:
1. Formica Corp.
  2. Nevamar Corp.
  3. Wilsonart International.
- B. High-Pressure Laminate: NEMA LD3, Grade 50, General Purpose, fire-rated, 0.048" thick.
- C. Section 01600 - Product Requirements: Product Options: Substitutions permitted.
- 2.8 ADJUSTABLE SHELVING
- A. Shelving: Softwood plywood; PS 1, graded in accordance with AWI; veneer cover core sides, edges and ends with plastic laminate; cover medium density particle board with factory-applied finish, as selected. 3/4" thick x depth shown on the Drawings x maximum possible length.
  - B. Standards: Heavy-duty, 2" slot adjustments, length as required. Knap & Vogt # 87 or comparable product as approved. Color as selected.
  - C. Brackets: Heavy-duty, for 2" slots, nylon cam lock lever, length as required. Knap & Vogt # 186 / 187 or comparable product as approved. Color as selected.
- 2.9 RELATED MATERIALS
- A. Closet Rod: 1-1/16" diameter stainless steel round tubing with chrome-plated mounting end flanges, Knap & Vogt # 660 or comparable product as approved. Provide support brackets when required by the manufacturer, of the same material and finish.
  - B. Anchorage Devices, General: Nails, screws, toggle bolts, expansion shields, and other devices, of type, size and finish required for each use to ensure strong connections. Where products are subject to moisture, provide hot-dipped galvanized products, otherwise electroplated zinc or cadmium anchorage devices are acceptable.
- 2.10 FABRICATION, GENERAL
- A. Field Measurements:
1. Before proceeding with the fabrication of finish carpentry products, obtain field measurements and verify dimensions.

FINISH CARPENTRY 06200-7

FINISH CARPENTRY 06200-6

- B. Wood Products:
1. Fabricate finish carpentry products to the dimensions, profiles and details indicated with the construction and materials complying with referenced standards of the specified AWI grades.
  2. Where necessary for fitting at the Project Site, provide reasonable allowance for scribing, trimming and fitting. Pre-cut openings, where possible, to receive hardware, and mechanical and electrical work.
  3. Ease edges of rectangular solid wood components to a 1/16" radius for members less than 1" in nominal thickness; 1/8" radius for edges of members over 1" in nominal thickness.
  4. Conceal all anchorage devices except where decorative fasteners are approved.
- 2.11 OTHER
- A. General: Where the quality of workmanship may not be specifically indicated, comply with the applicable provisions of AWI as follows as applicable to the grade of material, construction and finish:
    1. Scheduled for Opaque Painting: AWI, Custom Grade.
    2. Scheduled for Transparent Finish: AWI, Premium Grade.
  - B. Finish: Exposed wood surfaces (except resawn surfaces) shall be sanded and free of tool marks and similar blemishes. Hand sand inside the building after installation until all defects have been entirely removed. Any material showing machinery, tool, sandpaper or other defacing marks will be rejected.
- PART 3 EXECUTION
- 3.1 EXAMINATION
- A. Section 01700 - Execution Requirements: Verification of existing conditions before starting the work.
  - B. Verification of Conditions: Verify that field measurements, surfaces, substrates and conditions are as required and ready to receive the work.
  - C. Report, in writing, prevailing conditions that will adversely affect satisfactory execution of the work of this Section. Do not proceed with the work until the unsatisfactory conditions have been corrected.
- 3.2 FABRICATION
- A. Fabricate trim, moldings, bases and frames to the dimensions and profiles shown. Route and groove the backside of members to be applied to flat surfaces, except for members with ends exposed in the finished work.
  - B. Condition wood materials to the average prevailing humidity conditions in the installation areas prior to installing.

FINISH CARPENTRY 06200-8

- C. Backprime wood with scheduled finish material exposed on the exterior or, to high the moisture and high relative humidities on the interior.
  - D. Comply with the requirements of Section 09900 for primers and their application.
- 3.3 INSTALLATION
- A. Discard items which are unsound, warped, bowed, twisted, improperly treated, not adequately seasoned or are too small to fabricate work with a minimum number of joints or optimum jointing arrangements, or which are of defective manufacturer with respect to surfaces, sizes or patterns.
  - B. Install work in accordance with AWI, AWQS, Section 1700 - Installation of Woodwork.
  - C. Install the work plumb, level and straight without distortions. Shim as required using concealed shims. Install to a tolerance of 1/8" in 8'-0" for plumb and level countertops; and with 1/64" maximum offset in flush adjoining surfaces; 1/32" maximum offsets in revealed adjoining surfaces.
  - D. Scribe and cut the work to fit adjoining work. Refinish cut surfaces or repair damaged finish at cuts. Provide a neat, tight joint where work specified in this Section adjoins other work.
  - E. Anchor work items to nailers or blocking or directly to the substrate using concealed fasteners, to the extent possible.
  - F. Install standing and running trim with the minimum number of joints possible, using full-length pieces (from maximum length lumber available) to the greatest extent possible. Stagger joints in adjacent and related members. Cope at returns, miter at corners to produce tight fitting joints with full surface contact throughout the length of joints. Use scarf joints for end-to-end jointing.
  - G. Secure finish carpentry work to anchorage devices or blocking built-in or directly attached to substrates. Secure to grounds, stripping and blocking with countersunk, concealed fasteners and blind nail as required for a complete installation. Except where prefinished matching fastener heads are required, use fine finishing nails for exposed nailing, countersink and fill flush with the finished surface. Match the final finish where a transparent finish is indicated.
  - H. Apply sealant at all joints between finish carpentry work and adjacent walls and flooring to prevent intrusion by vermin and moisture into concealed spaces.
  - I. Install hardware in accordance with the manufacturer's published instructions.
  - J. Install shelving units, standards and brackets at locations indicated on the Drawings.
  - K. Finish: AWI quality standard. Leave finish carpentry in a paint-ready condition for final finishing by the painting applicator.
- 3.4 ADJUSTING AND TESTING
- A. Section 01700 - Execution Requirements: Adjusting and testing the installed work.
  - B. Adjust installed work.
  - C. Test the installed work for rigidity and ability to support loads.

FINISH CARPENTRY 06200-9

SECTION 06400

ARCHITECTURAL WOODWORK

- D. Adjust joinery for uniform appearance.
- E. Touch-up shop-applied finishes to restore damaged and soiled areas.
- F. Repair damaged and defective work wherever possible to eliminate defects functionally and visually; where repairs cannot be made to the satisfaction of the Owner's representative, replace the finish cabinetry.
- G. Adjust moving or operating parts to function smoothly and correctly.

3.5 FIELD QUALITY CONTROL

- A. Section 01450 - Quality Control: Field inspection.
- B. Inspect finish carpentry work for plumb, level, alignment and secure attachment.

3.6 CLEANING

- A. Section 01700 - Execution Requirements: Cleaning the installed work.
- B. Clean exposed and semi-exposed surfaces.

3.7 PROTECTION

- A. Installer shall advise the Contractor and painting applicator of procedures required to protect the finish carpentry during the remainder of the construction period to ensure that the work will be without damage and deterioration at the time of final acceptance, and will be comparable to the final finish scheduled for the work.
- B. Installer shall return to the Project prior to substantial completion, repair any damage to the work, and readjust the hardware.

END OF SECTION

PART 1 GENERAL

1.1 SUMMARY

A. Section Includes:

- 1. Wood faced casework and trim.
- 2. Plastic laminate faced casework and shelving.
- 3. Plastic laminate countertops.
- 4. Solid polymer fabrications.
- 5. Marble and Granite countertops.
- 6. Wood shelving.
- 7. Preparation for installation and connection of utilities.

B. Related Documents: The Contract Documents, as defined in Section 01010 - Summary of Work, apply to the work of this Section. Additional requirements and information necessary to complete the work of this Section may be found in other Documents.

C. Related Sections:

- 1. Section 06100 - Rough Carpentry: Blocking and backing plates in walls for anchorage.
- 2. Section 06200 - Finish Carpentry: Adjustable shelving.
- 3. Section 06640 - Solid Polymer Fabrications: Countertops.
- 4. Section 09110 - Non-Load Bearing Steel Framing: Blocking and backing plates.
- 5. Section 09900 - Painting: Woodwork finishes.
- 6. DIVISIONS 15 and 16: Service fittings and connections.

1.2 DESCRIPTION OF WORK

A. The extent of architectural woodwork is indicated on the Drawings and as specified herein, and includes providing, fabricating and installing all wood faced and plastic laminate faced architectural woodwork, trim and countertops, wood shelving, installations and utility connections.

1.3 REFERENCES

- A. The publications listed below form a part of this Specification to the extent referenced. Publications are referred to in the text by basic designation only.

FINISH CARPENTRY

06200-10

ARCHITECTURAL WOODWORK

06400 - 1

1. Product Data: Fabricator's specifications and installation instructions for each item of factory-fabricated woodwork, wood veneer counter tops, finish hardware and finish coating products.
  - a. Wood veneers and finishes.
  - b. Data for hardware and accessories indicating the material, type, function, attachment and finish.
2. Shop Drawings: Show the location of each item on dimensioned plans, sections, elevations, and large scale details. Indicate materials used, wood species, component profiles, assembly methods, joint details, fastening methods, accessory listings, hardware location and schedule of finishes. Submit for the following:
  - a. Cabinet work, base and overhead.
  - b. Counter work, base and overhead.
  - c. Shelving units.
  - d. Vanities.
  - e. Submit fabricators' product information including Shop Drawings for fabricator's standard units.
3. Samples: For each species and cut or pattern of architectural woodwork:
  - a. General:
    - 1). Two 12" x 12" solid wood and plywood or hard board samples with factory-applied transparent or opaque finish for each finish system and color required.
    - 2). Two samples of each countertop material.
    - 3). One unit of each type and finish of cabinet hardware.
  - b. Initial Samples: Unless specific products are scheduled, submit 2" x 2", minimum, size samples of the complete range of colors, patterns, and finishes available for initial selection.
  - c. Final Samples:
    - 1). Color, Pattern and Finish Samples: Submit 6" x 6" final samples matching those initially selected.
    - 2). Fused Joint Sample: On project products that would least likely obscure joints, submit 6" x 10" samples showing fused joint work.
4. Assurance / Control Submittals:
  - a. Fabricator's certificate that the products meet or exceed the specified requirements.

- B. American National Standards Institute (ANSI):
  1. ANSI A135.4 - Basic Hardboard.
  2. ANSI A208.1 - Mat Formed Wood Particleboard.
- C. Americans with Disabilities Act Accessibility Guidelines (ADAAG):
  1. Accessibility Guidelines for Building and Facilities.
  2. Accessibility Guidelines for Schools.
- D. Architectural Woodwork Institute (AWI):
  1. AWI AWQS - Architectural Woodwork Quality Standards, 6th Edition, [Premium] [Custom] Grade, except as otherwise indicated.
- E. National Electric Manufacturer's Association (NEMA):
  1. NEMA LD3 - High Pressure Decorative Laminates.
- F. United States Department of Commerce Product Standard (PS):
  1. PS 1 - Construction and Industrial Plywood.
  2. PS 20 - American Softwood Lumber Standard.

#### 1.4 DESIGN INTENT

- A. It is the design intent that similar woodwork throughout the Project match. Coordinate work between the separate installers providing similar woodwork to ensure that the design intent is achieved to the satisfaction of the Owner's representative.

#### 1.5 DEFINITIONS

- A. Exposed Surfaces: The exposed portions of woodwork, including surfaces visible when doors and drawers are closed. Bottoms of woodwork more than 4'-0" above the floor shall be considered as exposed. Visible members in open cases or behind glass doors also shall be considered as exposed. The front and both sides of all storage cabinets shall be considered as exposed, even when one or both side panels are against a wall or an adjacent cabinet.
- B. Semi-exposed Surfaces: Semi-exposed portions of woodwork includes members behind opaque doors, such as shelves, dividers, interior face of ends, wood back, drawer sides, backs and bottoms, and the inside face of doors. Tops of woodwork 6'-6" or more above the floor shall be considered as semi-exposed.
- C. Unexposed Surfaces: Unexposed portions of woodwork includes sleepers, web frames, dust panels and other surfaces not usually visible after installation.

#### 1.6 SUBMITTALS

- A. Section 01330 - Submittal Procedures: Procedures for submittals.

ARCHITECTURAL WOODWORK

06400 - 2

ARCHITECTURAL WOODWORK

06400 - 3

- b. Documentation of experience indicating compliance with the specified qualifications requirements.

- B. Section 01780 - Closeout Submittals: Procedures for closeout submittals.
  - 1. Warranty: Submit a written Warranty with forms completed in the name of the Owner and registered with the fabricator.

1.7 COORDINATION

- A. Pre-Installation Meeting: Convene a Pre-Installation Meeting at the Project Site prior to the delivery of architectural woodwork materials to the Site.
  - 1. Require attendance of the Contractor, Architect, Owner's representative, and representatives of the installer of finish carpentry, other finishes, painting and related mechanical and electrical work.
  - 2. Review coordination and environmental controls required for proper installation, and ambient conditions in areas to receive the work.
  - 3. Review preparation and installation procedures, and the coordination and scheduling required with related work.
- B. Support Work:
  - 1. For support work not indicated in the Contact Documents, coordinate the requirements with other installers, in a timely manner.
  - 2. Provide work as necessary to ensure that all work has proper framing, backing and reinforcing supports to ensure secure and solid installations.

1.8 QUALITY ASSURANCE

- A. Qualifications:
  - 1. Fabricator: Company specializing in manufacturing the products specified with a minimum of five (5) years documented experience.
  - 2. Installer: Company experienced in performing the work of this Section with a minimum of five (5) years documented experience.
- B. Quality Standards:
  - 1. Woodwork shall comply with the requirements of AWI Architectural Woodwork Quality Standards Illustrated®, Eighth Edition, 200, except where more stringent requirements are specified herein.
- C. Style: Fabricate, as indicated, utilizing the following:
  - 1. [Conventional Flush Construction with face frame.]
  - 2. [Conventional Flush Construction without face frame.]
  - 3. [Flush Overlay Construction.]
  - 4. [Reveal Overlay Construction.]

ARCHITECTURAL WOODWORK 06400 - 4

- 5. Wood faced casework - [Premium] [Custom] grade.
- 6. Countertop, casework and shelving - [Premium] [Custom] grade.
- 7. Wood shelving - [Premium] [Custom] grade.

1.9 DELIVERY, STORAGE AND HANDLING

- A. Section 01600 - Product Requirements: Transport, handle, store and protect the products.
- B. Package architectural woodwork in water-tight containers for transport to the Project Site to prevent damage, water damage, soiling and deterioration and for storage in a location other than inside the building, if necessary.
- C. Do not store woodwork on the Project Site for a long period of time. If, due to unforeseen circumstances, the woodwork must be stored in other than the installation areas, store only in areas meeting the requirements specified for the installation areas.
- D. Do not deliver woodwork until wet work, grinding, painting and similar operations which could damage, soil or deteriorate the woodwork has been completed in the installation areas, and humidity has been stabilized.
- E. Deliver products to the Project Site in the fabricator's original, new, unopened packaging, crates or containers.

1.10 JOB CONDITIONS

- A. The fabricator of woodwork shall determine the optimum moisture content and required temperature and humidity conditions.
- B. The installer shall advise the Contractor of the temperature and humidity requirements for the architectural woodwork installation areas. Do not install woodwork until the required temperature and relative humidity has been stabilized and will be maintained in the installation areas.
- C. Stabilize temperature and humidity in installation areas, as necessary, to maintain the moisture content of the installed woodwork within a 1.0% tolerance or optimum, from the date of installation throughout the remainder of the construction period.
- D. Unless instructed otherwise by the Installer, maintain the spaces to receive woodwork between 65° F and 80° F, with a relative humidity of 50% or less for 72 hours prior to, during and after installation until the date of Substantial Completion.

1.11 WARRANTY

- A. Section 01780 - Closeout Submittals: Procedures for closeout submittals.
- B. Fabricator's Warranty: Provide fabricator's standard Warranty against defects in product materials and workmanship.

PART 2 PRODUCTS

2.1 WOOD FACED CASEWORK AND TRIM

ARCHITECTURAL WOODWORK 06400 - 5

- b. High-Pressure Decorative Laminate: NEMA LD-3, GP-50, General Purpose:
  - 1). Nominal 0.050" thick for horizontal and high usage exposures.
  - 2). 0.028" thick for vertical and medium usage exposures.
  - 3). 0.020" thick, liner grade, for all semi-exposed faces inside drawers, doors, backs, shelves, etc.
  - 4). Color(s) as selected.
- c. Section 01600 - Product Requirements: Product Options: Substitutions permitted.
- 3. Laminated Plastic Adhesive: Type recommended by the laminated plastic manufacturer; bonded by machine application and pressure of not less than 100 pounds per square inch.
- 4. Edge Treatment: Top edges of drawer sides and drawer backs; edge of doors, fixed panels, visible frame parts and drawer face tops and edges shall be matching laminate faced or shall be resilient polyvinylchloride 0.024" thick, machine bonded with hot melt glue, factory edges trimmed, superfinished, buffed and polished.

2.3 PLASTIC LAMINATE COUNTERTOPS

- A. Plastic Laminate Tops:
  - 1. Core thickness of countertop substrate shall be 3/4" or 1" as indicated. Backsplash core shall be 3/4" or 1/2" in two-piece countertop applications.
  - 2. Finish wear surfaces, including all edges, shall be 0.050" plastic; velvet or satin finish, pattern or solid color, as selected from the manufacturer's standards.
  - 3. Underside of decks and back side of backsplashes shall have 0.02" balance sheet bonded to the substrate whether or not the countertop is in a wet® or adry® usage.
  - 4. Backsplash to deck joints shall be shoulder rabbited, glued, mechanically fastened, and sealed during assembly with a silicone compound; backsplash color shall be compatible with the deck color.
  - 5. Transverse deck joints shall be spaced as far apart as material limitations allow, shall be job sealed during installation with silicone compound, and shall be securely drawn together with concealed mechanical joint fasteners.
  - 6. Where noted on the Drawings, chemical-resistant countertop surfacing with solid-core edge banding shall be used when severe resistance to reagents is required.
  - 7. Use acid-resistant plastic laminate at Science Laboratories, Art Rooms and adjacent Storage Room counters.

2.4 SOLID POLYMER FABRICATIONS

- A. Provide fabrications of cast solid polymer material composed of acrylic polymer with mineral fillers and pigments where indicated. Material shall not be coated or laminate to

- A. AWI, [premium] [custom] grade, natural finish.
- B. Trim and Solid Stock: Solid, kiln dried, [premium] [custom] grad, wood species as selected.
- C. Core Stock: 3/4" plywood or medium density melamine particleboard; veneer finish at exposed faces, melamine or matching veneer finish at semi-exposed faces, outside and inside drawers, cabinet backs, shelves, etc.
- D. Species and Cut: Lumber and veneer for transparent and opaque finish shall be as indicated herein or in the Finish Schedule, interior drawings and details, or as selected.
- E. Factory Finished: Casework shall be factory finished per AWI 1500, System #5, catalyzed polyurethane, satin medium rubbed effect, filled finish.
- F. Backpriming: Back prime the work with a single coat of spar varnish or other acceptable sealer for fabricated units to be installed as an exterior component or where against portland cement plaster, gypsum plaster or against an exterior facing wall of concrete or masonry. Ensure that the sealer does not contaminate surfaces requiring a transparent finish.

2.2 PLASTIC LAMINATE FACED CASEWORK AND SHELVING

- A. Core Stock: Material shall be 45 pound density hard board, industrial grade.
  - 1. Minimum core thickness shall be 3/4" except:
    - a. Hidden cabinet backs may be 1/4" thick hardboard.
    - b. Exposed backs and drawer bottoms may be 1/4" thick.
    - c. Drawer sides may be 1/2" thick.
    - d. Backs of free standing cabinets may be 1/2", 5/8" or 3/4" thick, as indicated or required.
    - e. Cabinet bases (see spaces) may be solid kiln-dried wood, unfinished for finish applications by others.
    - f. Shelf thickness shall be 1" for any shelf over 36" long.
- 2. Laminated Plastic. Where Plam is indicated for exterior cabinet finish, all visible exposed faces and edges shall be covered with laminated plastic, unless otherwise specified herein. Provide backer as necessary to balance plastic laminate installation at concealed locations.
  - a. Fabricators: Subject to compliance with the Project requirements, fabricators offering products which may be incorporated into the work include the following:
    - 1). Formica Corporation.
    - 2). Nevamar Corporation.
    - 3). Wilsonart International.

ARCHITECTURAL WOODWORK

06400 - 6

ARCHITECTURAL WOODWORK

06400 - 7



substrates. Superficial damage to a depth of 1/64" shall be repairable by sanding or polishing. Products by:

- 1. Avonite Surfaces.
  - 2. DuPont Corian.
- B. Size:
- 1. Width / Height: Fabricator's standards of size best meeting the project requirements. Backsplash to be 4" in height, unless otherwise indicated.
  - 2. Thickness:
    - a. Horizontal surfaces - 3/4" minimum.
    - b. Vertical surfaces - 1/2" minimum; backsplashes - 3/4".
  - C. Finish: Polished, unless otherwise indicated. Top, backsplash and fascia shall be one-piece. Color, edge detail and pattern shall be as selected from the fabricator's standards.
  - D. Color / Pattern: The basis of design is products by Avonite or approved comparable color / pattern.
  - E. Related Materials:
    - 1. Panel Adhesive: Fabricator's standard specifically recommended for the Project application. Adhesives used at installations exposed to water or high humidity conditions to be water-resistant type.
    - 2. Joint Adhesive: Fabricator's standard capable of fusing each joint and creating inconspicuous and non-porous joints.
    - 3. Sealant: Fabricator's recommended mildew resistant, FDA / UL recognized silicone sealant, in colors custom matched to each component where sealant is required.
    - 4. Mounting Hardware: Provide mounting hardware including sink / bowl clips, inserts and fasteners for the attachment of undermount sinks and lavatories.
    - 5. Anchorage Devices: Fabricator's approved clips, inserts, and anchorage devices. Ferrous products to be hot-dipped galvanized. Do not use metal types not specifically approved by the fabricator for their products.
  - F. Fabrication:
    - 1. Factory fabricate components to the greatest extent possible, to the sizes and shapes indicated, in accordance with the approved Shop Drawings. Where indicated, factory fabricate side and back splashes with 1/2" cove at intersections.
    - 2. Form joints between components using the fabricator's standard acrylic joint adhesive. Joints shall be inconspicuous, non-porous, and reinforced with strips of solid polymer material in accordance with the fabricator's printed instructions.
    - 3. Tolerances:

- a. Variation of component size: +/- 1/8".
  - b. Location of openings: +/- 1/8" from the required location.
- 4. Provide factory cutouts for plumbing and accessories as indicated. Reinforce heated or cooled cutouts in accordance with the Approved Shop Drawings and the fabricator's printed instructions.
  - 5. Cut an finish components edges with clean returns. Round edges of cutouts to 1/8" radius. Round corners of cutouts with 1/2" minimum radius. Use router to form all cutouts. Provide thick edges where indicated using strips of solid polymer material and fabricator's acrylic joint adhesive. All joints to be inconspicuous and non-porous. All exposed surfaces to have a uniform finish and gloss.
  - 6. Countertop Joint Layout: Provide a monolithic look to the greatest extent possible. Where joints in the work is required due to fabrication limitations or required for proper performance of the product, work with the Owner's representative to establish satisfactory joint locations.

#### 2.5 MARBLE AND GRANITE COUNTERTOPS

- A. Thickness shall be 3/4", minimum.
- B. Edge detail shall be as selected.
- C. Top, backsplash and fascia shall be a color and pattern selected from the fabricator's standards. Location of joints shall be shown on shop drawings.

#### 2.6 WOOD SHELVING

- A. Softwood plywood, PS 1, graded in accordance with AWI.
- B. Veneer cover core sides and ends with plastic laminate, color as selected.
- C. Cover medium density particleboard with factory-applied finish, as selected.
- D. Dimensions: 3/4" thick x depth shown on the Drawings x maximum possible length.

#### 2.7 CABINET HARDWARE AND ACCESSORY MATERIALS

- A. General: Provide complete cabinet hardware and accessory materials associated with the architectural woodwork, except for units specified as door hardware® in other Sections of these Specifications.
- B. Hardware References: Except as otherwise indicated, comply with ANSI A156.9 American National Standard for Cabinet Hardware®.
- C. Cabinet Door Hardware: Provide hinges and pulls of the types indicated, to accommodate each door size and style. Hinges concealed European® style; Pulls - EPCCO DP-418 x 3-1/2" wire pull or as indicated or approved.
  - 1. Each cabinet door up to 36" in height shall have one pair of hinges; up to 48" in height, 1-1/2 pair hinges; over 48" in height, two pair of hinges. Each cabinet shall be equipped with sound dampening cushions to minimize noise.

ARCHITECTURAL WOODWORK

06400 - 8

ARCHITECTURAL WOODWORK

06400 - 9

- D. Drawer Hardware: Provide slides and pulls of the types indicated, to accommodate each drawer size and style.
1. Equip each drawer with side-mounted, full-extension, ball-bearing, nylon roller drawer slides with a load capacity of 75 pounds per pair; provide stay-closed® feature for lift out removal.
- E. Looks: Provide standard pin-type or disc-type (five pins or discs) tumbler locks, keyed individually, except as otherwise indicated.
- F. Shelf Supports: Where shelving is indicated as adjustable®, provide pin-type or slotted-type standards and brackets of a type required to support shelves with a uniform load of 40 pounds per square foot; recessed for premium construction, surface-mounted for custom and economy construction.

## 2.8 ACCESSORIES

- A. Adhesive: Type recommended by AWI to suit the application.
- B. Fasteners: Size and type to suit the application.
- C. Bolts, Nuts, Washers, Lags, Pins and Screws: Of the size and type to suit the application.
- D. Concealed Joint Fasteners: Threaded, hot-dipped galvanized steel.
- E. Sealant: Manufacturer's recommended mildew resistant, FDA / UL recognized silicone sealant in colors custom matched to each component where sealant is required.
- F. Anchorage Devices: Fabricator's project approved clips, inserts, and anchorage devices. Ferrous products to be hot-dipped galvanized. Do not use metal types not specifically approved by the fabricator for their products.

## 2.9 FABRICATION

- A. Field Measurements:
  1. Before proceeding with the fabrication of architectural woodwork products, obtain field measurements and verify dimensions.
- B. Wood Products:
  1. Fabricate architectural woodwork products to the dimensions, profiles and details indicated, with construction and materials complying with the referenced standards of the specified AWI grades. Where necessary for fitting at the Project Site, provide reasonable allowance for scribing, trimming and fitting. Pre-cut openings, where possible, to receive hardware and mechanical and electrical work.
  2. Conceal all anchorage devices, except where decorative fasteners are approved.
- C. Fire-Retardant Treatment:
  1. Where fire-retardant wood is specified or otherwise indicated, provide materials which comply with AWPA standards for pressure impregnation with fire-retardant chemicals, and which have a flame spread rating of not more than 25 when tested in accordance with UL 723 or ASTM E 84, and show no increase in flame spread

ARCHITECTURAL WOODWORK

06400 – 10

2. Where treated items are exposed to the exterior or to high humidity or are to have a transparent stain or sealer finish, provide appearance grade materials which show no change in the fire hazard classification when subjected to standard rain test per UL 790 or ASTM B 2898.
3. Use fire-retardant treatment which will not bleed through or adversely affect the type of finish indicated, and which does not require brush treatment of field made end cuts to maintain the fire-hazard classification.

## D. Products Scheduled for Transparent Finish:

1. Treatment color shall be compatible with products scheduled for a transparent finish. Provide samples of treatment with finish applied for review.
2. Where a transparent finish is indicated, use the type of treatment and species which permits milling of the lumber after treatment without altering the indicated fire-hazard classification, as determined by fire testing.

## PART 3 EXECUTION

### 3.1 EXAMINATION

- A. Section 01700 - Execution Requirements: Verification of existing conditions before starting the work.
- B. Verification of Conditions: Verify that field measurements, surfaces, substrates and conditions are as required and ready to receive the work.
- C. Report, in writing, prevailing conditions that will adversely affect satisfactory execution of the work of this Section. Do not proceed with the work until the unsatisfactory conditions have been corrected.

### 3.2 PREPARATION

- A. Condition woodwork to the average prevailing humidity conditions in the installation areas before installing.
- B. Install concrete inserts and similar anchoring devices to be built into substrates well in advance of the time the substrates are to be built.
- C. Prior to the installation of architectural woodwork, examine shop fabricated units for completion, and complete work as required, including back priming and removal of packing.

### 3.3 INSTALLATION

- A. Set and secure fixtures in place at the locations indicated on the Drawings.
- B. Cabinets and countertops shall be installed by factory-trained personnel, or by personnel experienced in installing the type of countertops and splashes required.

ARCHITECTURAL WOODWORK

06400 – 11

- C. Install the work plumb, level, true and straight with no distortions. Shim as required using concealed shims.
- D. Scribe and cut work to fit adjoining work; refinish cut surfaces or repair damaged finishes at cuts in strict accordance with the fabricator's instructions.
- E. Secure woodwork to anchorage devices or blocking built-in or directly attach to substrates. Secure to grounds, stripping and blocking with countersunk, concealed fasteners and blind nail as required for a complete installation. Except where prefinished matching fastener heads are required, use fine finishing nails for exposed nailing, countersink and fill flush with the woodwork surface. Match the final finish where transparent finish is indicated.
- F. Casework: Install without distortion so doors and drawers fit openings properly and are accurately aligned. Adjust hardware to center doors and drawers in openings and to provide unencumbered operation. Complete the installation of hardware and accessory items as indicated. Maintain the indicated veneer sequence matching of casework with transparent finish.
- G. Secure fixtures to the floor using appropriate angles and anchorages.
- H. Countertops: Anchor securely to base units and other supports as indicated, in strict accordance with the fabricator's instructions.
- I. Wood Storage Shelving: Complete the assembly of units and install in the locations indicated, including hardware and accessories, as indicated.
- J. Finish: AWI quality standard. Leave woodwork in paint ready condition for final finishing by the painting applicator.
- K. Apply sealant at all joints between architectural woodwork and adjacent floor and walls.

3.4

CONSTRUCTION

- A. Interface with Other Work:
  - 1. Coordinate the installation sequence of fixtures with the trades providing utilities to the units.
- B. Tolerances:
  - 1. Fabrication: Variation of Components Size: + 1/8". Location of Openings: + 1/8" from the required location.
  - 2. Installation: 1/8" in 8'-0" for plumb and level, including countertops, and with 1/64", maximum, offset in flush adjoining surfaces; 1/32" maximum offsets in revealed adjoining surfaces.
- C. Finishing:
  - 1. Repair damaged and defective woodwork wherever possible to eliminate defects functionally and visually. Where not possible to repair to the satisfaction of the Owner's representative, replace the woodwork.
  - 2. Touch-up shop applied finishes to restore damaged and soiled areas.
  - 3. Adjust joiner for a uniform appearance.

- 4. Complete the finishing work specified as work of this Section, to whatever extent not completed in the shop or prior to installation of the woodwork.

3.5 ADJUSTING

- A. Section 01700 - Execution Requirements: Adjusting the installed work.
- B. Lubricate and make final adjustment of moving and operating parts for smooth and correct operation.

3.6 FIELD QUALITY CONTROL

- A. Section 01450 - Quality Control: Field inspection.
- B. Inspect woodwork installations for flush, plumb, level, alignment and secure attachment to substrates.

3.7 CLEANING

- A. Section 01700 - Execution Requirements: Cleaning and protection of installed work.
- B. Clean casework, counters, shelves, hardware, fittings and fixtures.
- C. Clean woodwork on exposed and semi-exposed surfaces.

3.8 PROTECTION

- A. Installer shall advise the Contractor and paint applicator of the procedures required to protect the woodwork during the remainder of the construction to ensure that the work will be without damage and deterioration at the time of final acceptance.
- B. Installer shall return to the Project prior to substantial completion, repair any damage to the work and readjust the hardware.

END OF SECTION

SECTION 06650

SOLID POLYMER FABRICATIONS

PART 1 GENERAL

1.1 SUMMARY

A. Section Includes:

1. Countertops.
2. Work surfaces.
3. Vanities.
4. Window sills.
5. Preparation for installation and connection of utilities.

B. Related Documents: The Contract Documents, as defined in Section 01010 - Summary of Work, apply to the work of this Section. Additional requirements and information necessary to complete the work of this Section may be found in other Documents.

C. Related Sections:

1. Section 06400 - Architectural Woodwork: Support for countertops, work surfaces and vanities.
2. Section 07900 - Joint Sealers: Sealants for joints.
3. Section 09110 - Non-Load Bearing Steel Framing: Blocking and backing plates in walls.
4. Section 09250 - Gypsum Board: Adjacent wall substrate.
5. Section 12305 - Science Casework and Laboratory Equipment: Support for countertops.
6. Division 15 - Plumbing Fixtures.
7. Division 16 - Wiring Devices.

1.2 DESCRIPTION OF WORK

A. The extent of solid polymer fabrications work is indicated on the Drawings and as specified herein, and includes providing and installing cast synthetic polymer fabrications, splashes, inlays, adhesive, sealant, mounting accessories and preparation for installation of plumbing fixtures, and mechanical and electrical services by other trades.

1.3 REFERENCES

A. The publications listed below form a part of this Specification to the extent referenced. Publications are referred to in the text by basic designation only. Comply with the

SOLID POLYMER FABRICATIONS 06650-1

applicable standards of the following, as referenced herein.

B. American National Standards Institute (ANSI):

1. ANSI Z124.3 - Plastic Lavatories.
2. ANSI Z124.6 - Plastic Sinks.

C. American Society for Testing and Materials (ASTM):

1. ASTM C 501 - Test Method for Relative Resistance to Wear of Unglazed Ceramic Tile by the Taber Abraser.
2. ASTM D 256 - Test Methods for Determining the Izod Pendulum Impact Resistance of Plastics.
3. ASTM D 570 - Test Method for Water Absorption of Plastics.
4. ASTM D 638 - Test Method for Tensile Properties of Plastics.
5. ASTM D 696 - Test Method for Coefficient of Linear Thermal Expansion of Plastics Between -30E C and 30E C With a Vitreous Silica Dilatometer.
6. ASTM D 785 - Test Method for Rockwell Hardness of Plastics and Electrical Insulating Materials.
7. ASTM D 790 - Test Method for Flexural Properties of Unreinforced and Reinforced Plastics and Electrical Insulating Materials.
8. ASTM D 2583 - Test Method for Indentation Hardness of Rigid Plastics by Means of a Barcol Impressor.
9. ASTM E 84 - Test Method for Surface Burning Characteristics of Building Materials.
10. ASTM G 21 - Practice for Determining Resistance of Synthetic Polymeric Materials to Fungi.
11. ASTM G 155 - Practice for Operating Xenon Arc Light Apparatus for Exposure of Non-Metallic Materials.

D. Americans with Disabilities Act Accessibility Guidelines (ADAAG):

1. Accessibility Guidelines for Buildings and Facilities.
2. Accessibility Guidelines for Schools

E. National Electrical Manufacturers Association (NEMA):

1. NEMA LD3 - High Pressure Decorative Laminates.

F. National Fire Protection Association (NFPA):

1. NFPA 255 - Method of Test for Surface Burning Characteristics of Building Materials.

SOLID POLYMER FABRICATIONS 06650-2

- G. Underwriters Laboratories, Inc. (UL):
1. UL 723 - Test for Surface Burning Characteristics of Building Materials.
  - H. U. S. Environmental Protection Agency (EPA):
    1. Method 24 - Determination of Volatile Matter Content.

1.4 SUBMITTALS

A. Section 01330 - Submittal Procedures: Procedures for submittals.

    1. Product Data: Manufacturer's current product literature for each product indicated.
    2. Shop Drawings: Show the location of each item, dimensioned plans, elevations, large scale details, construction joint locations, termination points, attachment devices and other components. Show locations and sizes of furring, blocking, including concealed blocking and reinforcement specified in Section 09110. Show locations and sizes of cutouts and hole for plumbing fixtures, faucets, soap dispensers, waste receptacle and other items to be installed in the solid surface.
    3. Samples:
      - a. Initial Samples: Unless specific products are scheduled, submit 2" x 2", minimum, size samples of the manufacturer's complete range of colors, patterns, and glosses for initial selection.
      - a. Final Samples:
        - 1). Submit two (2) 6" x 6" final samples matching the color, pattern and gloss of those initially selected.
        - 2). Fused Joint Sample: Submit 6" x 10" samples showing fused joint work.
        - 3). One sample or each will be retained at the Project Site as the standard for the work.
    4. Assurance / Control Submittals:
      - a. Manufacturer's certificate that the products meet or exceed the specified requirements.
      - b. Manufacturer's Material Safety Data Sheets (MSDS).
      - c. Manufacturer's / Fabricator's certification that the products supplied comply with applicable federal and local regulations controlling the use of volatile organic compounds (VOC).
      - d. Manufacturer's instructions indicating procedures and conditions requiring special attention, and cautionary procedures required during fabrication.
      - e. Documentation of experience indicating compliance with the specified qualifications requirements.

SOLID POLYMER FABRICATIONS 06650-3

- f. Signed copy of the Fabricator's certificate, acknowledging that he / she has been trained and approved by the manufacturer.
- B. Section 01780 - Closeout Submittals: Procedures for closeout submittals.
  1. Warranty: Provide a written special Warranty with forms completed in the name of the Owner and registered with the fabricator.
  - C. Maintenance Data: Submit Manufacturer's care and maintenance data, including repair and cleaning instructions.

1.5 QUALITY ASSURANCE

A. Qualifications:
 

  1. Manufacturer: Company specializing in manufacturing the products specified with a minimum of five (5) years documented experience.
  2. Fabricator / Installer: Certified by the manufacturer, and has successfully completed fabrications of the type required for this Project, and has been continuously engaged in this type of work for not less than five (5) years.

B. Field Measurements: When possible, take field measurements prior to the preparation of Shop Drawings and fabrication to ensure proper fitting of the work, otherwise, indicate field measurements on the final Shop Drawings.

C. Installation to be by the Fabricator of the products, for single source responsibility.

1.6 DELIVERY, STORAGE AND HANDLING

A. Section 01600 - Product Requirements: Transport, handle, store and protect the products.

B. Package products in packages, crates or containers for transport to the Project Site to prevent damage, water damage, soiling and deterioration.

C. Deliver sheets, fabricated items, materials and components to the Project Site in the fabricator's original, new, unopened, undamaged packages, crates or containers with identification labels intact.

D. Do not deliver products until wet work, grinding, painting and similar operations have been completed in the installation areas.

E. If due to unforeseen circumstances, the fabrications must be stored in other than the installation areas, store only in areas meeting the requirements specified for the installation areas.

1.7 JOB CONDITIONS

A. The Installer shall advise the Contractor of the temperature requirements for the installation areas.

B. Do not install the fabrications until the required temperature has been stabilized and will be maintained in the installation areas.

1.8 WARRANTY

SOLID POLYMER FABRICATIONS 06650-4

- A. Section 01780 - Closeout Submittals: Procedures for closeout submittals.
- B. Special Warranty:
  - 1. Submit a written Warranty jointly signed by the solid polymer manufacturer and the fabricator certifying that the products and the installation is free of defective materials and workmanship, and will repair or replace any defective component or the fabrication, in whole or in part, as necessary to restore the product to its original intended state and integrity.
  - 2. Warranty Period: Ten (10) years from the date of Substantial Completion.

1.9 MAINTENANCE

- A. Section 01780 - Closeout Submittals: Procedures for closeout submittals.
- B. Provide manufacturer's maintenance kit for finishes.

PART 2 PRODUCTS

2.1 MANUFACTURERS

- A. Subject to compliance with the Project requirements, manufacturers offering products which may be incorporated into the work include the following:
  - 1. Avonite Surfaces by Aristech Acrylics LLC..
  - 2. Corian by DuPont, Inc.
- B. Section 01600 - Product Requirements: Product Options: Substitutions: Not permitted.

2.2 MATERIALS

- A. General:
  - 1. Studio Collection by Avonite.
  - 2. D Series Corian by DuPont.
- B. Description:
  - 1. Non-porous, homogeneous material maintaining the same composition throughout, with a composition of polyester or acrylic polymer, aluminum trihydrate filler and pigment
  - 2. Thickness: 3/4", unless shown otherwise specified.
  - 3. Colors and patterns, as selected, from the manufacturer's full line of standard colors and patterns
  - 4. Adhesive: Water-based adhesive as recommended by the polymer manufacturer for the substrate and conditions.
  - 5. Sealant: Mildew-resistant, FDA-compliant as recommended by the manufacturer; color to match the solid surface material.

SOLID POLYMER FABRICATIONS 06650-5

2.3 FABRICATION

- A. General:
  - 1. Factory fabricate by a solid polymer manufacturer's certified fabricator.
  - 2. Comply with the details shown for profile and construction of fabrications. Where not otherwise shown, comply with the manufacturer's written instructions.
  - 3. Provide separate countertops for installation on casework or other support systems, as indicated.
  - 3. Measurements: Before proceeding with fabrications required to be fitted to other construction, obtain measurements and verify the dimensions and Shop Drawings details, as required for an accurate fit. Where measuring substrates before fabrication would delay the project, proceed with the fabrication and provide sufficient borders and edges to allow for subsequent scribing and trimming for an accurate fit.
  - 4. Fabricate from single piece material, except where the required length exceeds the maximum length produced by the manufacturer. Locate joints at even intervals through the material, aligned with other adjacent joints, and as approved on the final Shop Drawings. Form joints using the manufacturer's recommended adhesives for a smooth even appearance with matching color for an inconspicuous appearance. Provide joints of an equal or greater strength than the material being joined.
  - 5. Pre-Cut Openings: Pre-cut openings in fabrications, wherever possible, to receive plumbing fixtures, electrical work and similar items. Locate the openings accurately, and use templates or roughing-in diagrams for the proper size and shape. Smooth edges of cutouts and, where located in countertops and similar exposures, seal the edges of cutouts with a water-resistant material.
  - 6. Cutouts for sinks and lavatories shall be smooth and uniform without saw marks. The top and bottom of openings shall be finished smooth. Where edges are exposed, fabricate with 1/16" radius; 1/4" radius at cutouts, or as indicated.
  - 7. Fabricate to accommodate plumbing fixtures, trim and drains.
- A. Countertops and Work Surfaces:
  - 1. Fabricate tops from 3/4" thick material with 1/2" thick x 6" high splashes and 2" skirts, unless otherwise indicated. Include 3/4" thick solid support braces with aluminum angle clips for interconnection of components.
- C. Vanities:
  - 1. Fabricate tops from 3/4" thick material with 1/2" thick x 6" high splashes and 4" skirt, unless otherwise indicated.
- D. Window Sills:
  - 1. Provide sizes and profiles as detailed. Where joints are required, locate at the center of openings or at the center line of window mullions.

SOLID POLYMER FABRICATIONS 06650-6

PART 3 EXECUTION

3.1 EXAMINATION

- A. Section 01700 - Execution Requirements: Verification of existing conditions before starting the work.
- B. Verification of Conditions: Verify that field measurements, surfaces, substrates and conditions are as required, and ready to receive the work.
- C. Report, in writing, prevailing conditions that will adversely affect satisfactory execution of the work of this Section. Do not proceed with the work until the unsatisfactory conditions have been corrected.

3.2 INSTALLATION

- A. General:
  - 1. Comply with manufacturer's recommendations.
  - 2. Cure fabrications for 24 hours, minimum, before exposure to moisture or pressure.
  - 3. Install the work plumb, level, true and straight with no distortions. Shim as required, using concealed shims. Install to a tolerance of 1/64" in 8'-0" for plumb and level; and with 1/32" maximum offsets in revealed adjoining surfaces.
  - 4. Scribe and cut work to fit adjoining work. Refinish cut surfaces and repair damaged finish at cuts.
- B. Anchorage:
  - 1. Anchor fabrications to anchors or blocking built-in or directly attached to substrates as detailed. Secure to grounds, stripping and blocking with concealed fasteners as required for a complete installation.
  - 2. Securely anchor countertops to base units and other support systems as indicated.
- C. Countertops, Work Surfaces and Vanities:

- 1. Anchor units to supports using concealed fasteners. Do not use continuous adhesive application. Field cut as required for plumbing fixtures and fittings. Plumbing fixtures, trim, drains, and connections are specified in Division 15. At recesses, install loose splashes with adhesive. Seal joints and perimeter with matching acrylic sealant as specified in Section 07900 - Joint Sealers, except at Vanities, use matching mildew-resistant silicone sealant as specified in Section 07900.

D. Window Sills:

- 1. Anchor window sills to substrate with non-staining adhesive as recommended by both stool and adhesive manufacturer. Cut and trim to fit with joints only at

SOLID POLYMER FABRICATIONS

06650-7

SOLID POLYMER FABRICATIONS

06650-8

approved locations. Make seamless joints. Fill joints between stools and other materials with acrylic sealant as specified in Section 07900.

3.3 ADJUSTING

- A. Section 01700 - Execution Requirements: Adjusting the installed work.
- B. Repair soiled, damaged and defective fabrications wherever possible to eliminate defects functionally and visually; where not possible to repair properly, replace the fabrications.

3.4 FIELD QUALITY CONTROL

- A. Section 01450 - Quality Control: Field inspection.
- B. Inspect installations for level, inconspicuous joints, tight fit to adjacent surfaces and secure attachment to substrates.

3.5 CLEANING

- A. Section 01700 - Execution Requirements: Cleaning the installed work.
- B. Clean exposed and semi-exposed surfaces.
- C. Remove adhesives, sealants and other stains.

3.6 PROTECTION

- A. The Fabricator / Installer shall advise the Contractor of the protection and maintained conditions necessary to ensure that the work will be without damage or deterioration at the time of final acceptance.

END OF SECTION

SECTION 07110  
WATERPROOFING

PART 1 GENERAL

1.1 SUMMARY

A. Section Includes:

1. Below grade walls waterproofing.
2. Existing below grade walls affected by new construction waterproofing.
3. Planters waterproofing.
4. Concrete parking and traffic decks waterproofing.
5. Horizontal roof slabs supporting earth waterproofing.
6. Split concrete slabs waterproofing.

B. Related Documents: The Contract Documents, as defined in Section 01010 - Summary of Work, apply to the work of this Section. Additional requirements and information necessary to complete the work of this Section may be found in other Documents.

C. Related Sections:

1. Section 03300 - Cast-In-Place Concrete: Substrate for waterproofing.
2. Section 04230 - Reinforced Unit Masonry: Substrate for waterproofing.
3. Section 04400 - Natural Stone: Dampproofing under natural stone.
4. Section 07190 - Water Repellents (Sealer): Water repellents and slurry coat dampproofing.
5. Section 09300 - Tile: Dampproofing under ceramic and quarry tile flooring.

1.2 DESCRIPTION OF WORK

A. The extent of each type of waterproofing is indicated on the Drawings and as specified herein, and includes providing and installing all waterproofing materials. Similar work used as an exposed finish is excluded by definition and, if required, is specified as roofing, flooring, special coating or other appropriate category.

1.3 REFERENCES

- A. The publications listed below form a part of this Specification to the extent referenced. Publications are referred to in the text by basic designation only.
- B. American Society for Testing and Materials (ASTM):
  1. ASTM C 642 - Test Method for Water Absorption.
  2. ASTM D 56 - Test Method for Flash Point by Closed Cup Tester.

WATERPROOFING 07110-1

3. ASTM D 3960 - Practice for Determining Volatile Organic Compound (VOC) Content of Paints and Related Coatings.

4. ASTM E 514 - Test Method for Water Penetration and Leakage Through Masonry.  
C. U. S. Environmental Protection Agency (EPA):

1. Method 24 - Determination of Volatile Matter Content.

1.4 SUBMITTALS

A. Section 01330 - Submittals: Procedures for submittals.

1. Product Data: Submit manufacturer's specifications, recommendations for water repellents for each surface specified, performance data, surface preparation and application instructions, precautions for materials which can contaminate the system, limitations to coating, protection and cleaning instructions and VOC content. Include recommendations for sealing penetrations, cracks and control, construction and expansion joints. Submit color charts for products required to be integrally colored.

2. Shop Drawings: Indicate details critical to water tightness of the membrane, including, but not necessarily limited to, membrane transitions / terminations at perimeters, drains, sleeves and other penetrating elements.

3. Samples: For each type of waterproofing system, submit a 8-1/2" x 11" board sample of each complete system. Where the membrane is a layered system, expose at least 1" of each succeeding layer. Top coats to be provided with Project required colors as selected.

4. Assurance / Control Submittals:

- a. Manufacturer's certificate that the products meet or exceed the specified requirements.
- b. Manufacturer's Material Safety Data Sheets (MSDS).
- c. Manufacturer's certification that the products supplied comply with applicable federal and local regulations controlling the use of volatile organic compounds (VOC).
- d. Manufacturer's instructions indicating procedures and conditions requiring special attention, and cautionary procedures required during application.
- e. Documentation of experience indicating compliance with the specified qualifications requirements.

C. Section 01780 - Closeout Submittals: Procedures for closeout submittals.

1. Warranty: Submit a written special Warranty with forms completed in the name of the Owner and registered with the manufacturer.

1.5 QUALITY ASSURANCE

A. Qualifications:

WATERPROOFING 07110-2



- indicate the date, time of day, length of each visit, weather condition during the visit, condition of the substrate at the time of application, application procedures, and other important aspects that affect success of the application. Submit Reports within seven (7) days after each Site visit.
- F. Performance Requirements: It is required that the waterproofing membrane be watertight, and not deteriorate in excess of the limits published by the membrane manufacturer.
- 1.6 COORDINATION
- A. Pre-Application Conference: Prior to start of the application of materials, meet at the Project Site with the Owner's representative, Architect, Contractor, Applicator and subcontractors whose work penetrates the surfaces to be waterproofed. Review the conditions, methods and procedures necessary for application of the work, including inspections of the areas of work, requirements of the Specifications and the manufacturer's literature; review submittals and schedules.
- B. Tolerances / Finish of Substrates: Coordinate with other trades providing substrates over which the waterproofing is scheduled for the required tolerances, conditions and finish of the substrates necessary to ensure successful application of the work of this Section. Coordinate in a timely manner so other trades can implement their requirements in accordance with the Job Schedule. Submit documentation of the coordination, including the date of the coordination, with whom coordinated, and the requirements specified.
- C. Control Joints: Control joints are indicated on the Drawings. Where additional or other configuration for control joints is required in substrates other than what is currently required to ensure success of each membrane application, submit the requirements to the Owner's representative for review, and arrange with the substrate installer for installation of such control joints.
- 1.7 DELIVERY, STORAGE AND HANDLING
- A. Section 01600 - Product Requirements. Transport, handle, store, and protect the products.
- B. Deliver products to the Project Site in the manufacturer's original, new and unopened packages or containers with seals and labels intact; dry and undamaged, bearing the product name, color, manufacturer's lot number, directions for use and precautionary labels.
- C. Store materials not in actual use, in tightly covered containers. Maintain containers used in the storage of materials, in a clean condition, free of foreign materials and residue.
- D. Store materials in a well ventilated area, and in compliance with the manufacturer's published instructions.
- E. Store and handle materials to prevent deterioration and damage due to moisture, temperature changes, contaminants, and other causes.
- F. Protect against fire hazards and spontaneous combustion.
- G. Keep storage areas neat and orderly. Remove waste daily.
- H. Take all precautions to ensure that workmen and the work areas are adequately protected from health hazards resulting from handling, mixing and application of the materials.
- 1.8 JOB CONDITIONS

WATERPROOFING 07110-4

1. Manufacturer: Company specializing in manufacturing the products specified with a minimum of five (5) years documented experience, and has a record of successful in-service performance.
2. Applicator: Company experienced in applying the types of waterproofing required for this Project for not less than five (5) years, and is acceptable to the primary waterproofing materials manufacturer. Employees assigned to the Project shall have been trained by an approved waterproofing materials manufacturer.
- B. Mockup: Apply water repellent to a mockup, either partial or full coverage, as directed, before proceeding with the application. Comply with the application requirements contained herein.
- C. Regulatory Requirements: Comply with applicable rules and regulations of the pollution-control regulatory agency having jurisdiction regarding volatile organic compounds (VOC) and use of hydrocarbon solvents.
- D. General: Obtain the primary materials from a single manufacturer. Provide secondary materials only as recommended by the manufacturer of the primary materials.
- E. Manufacturer's Technical Representative:
- The primary waterproofing materials manufacturer to make a Technical Representative available to monitor the on-going work to ensure proper application of the waterproofing system. The manufacturer must maintain the same Technical Representative for the duration of the Project.
  - Pre-Application Review: Prior to the start of work and the purchase of any materials, the Manufacturer's Technical Representative, who is to certify each application, shall visit the Project Site, review existing conditions, and review the Contract Document for appropriateness of the requirements with the specified manufacturer's system including, but not necessarily limited to membrane requirements, substrate preparation, membrane terminations, reinforcements, flashing conditions, penetrations, including multiple penetration requirements, joints required and treatment and protection of the membrane.
  - Certification: After the Manufacturer's Technical Representative's review, submit written certification of the appropriateness of the requirements, or submit other or additional specific recommendations, if any, to assure that the specified system is appropriate for the use intended and complete in scope to assure its intended performance. This should be coordinated with the Shop Drawing Submittal.
  - Substrate Certification: Submit the Technical Representative's written certification of compliance that the prepared substrate is in conformance with requirements necessary for the system installation. Certification of the substrate is to be accomplished just prior to the start of application of the membrane system.
  - Technical Representative's Field Review of Work:
    - Number of Site Visits: Submit the manufacturer's recommended minimum number of times the Technical Representative is to field review the work to ensure success of the installation. Indicate when such visits are to be made.
    - Field Reports: For each visit, the Technical Representative shall submit a detailed Field Report assessing each application. Field Reports to

WATERPROOFING 07110-3

- A. Proceed with the waterproofing work only after the substrate construction and penetrating work has been completed.
- B. Environmental Requirements: Do not apply products under any of the following conditions, except with the written recommendation of the manufacturer:
  1. Substrate surfaces cured less than thirty (30) days.
  2. Surfaces not dry for a minimum of 24 hours.
  3. Rain predicted within 24 hours.

1.9 WARRANTY

- A. Section 01780 - Closeout Submittals: Procedures for closeout submittals.
- B. Special Warranty:
  1. Provide a joint and severable written Warranty signed by the waterproofing materials manufacturer, Contractor and the Applicator, agreeing to repair or replace defective materials and workmanship, defined to include leakage of water, ruptures caused by cracking substrate up to 1/16", abnormal aging or deterioration of materials, and other failures of membranes to perform as required within the warranty period. Warranty shall include responsibility for removal and replacement of other work which conceals the waterproofing membrane.
  2. During the warranty period, repairs and replacements required because of acts of God and other events beyond the Contractor's / Applicator's control, and which exceed the performance requirements, shall be completed by the Contractor / Applicator and paid for by the Owner at the prevailing rates.
  3. Warranty Period: Five (5) years from the date of Substantial Completion of the waterproofing work.

PART 2 PRODUCTS

2.1 MANUFACTURERS

- A. Subject to compliance with the Project requirements, manufacturers offering products which may be incorporated into the work include the following:
  1. Urethane Polymers International (UPI).
  2. Carlisle Coatings and Waterproofing, Inc. (CCW).
- B. Section 01600 - Product Requirements: Product Options: Substitutions permitted.

2.2 SYSTEM

- A. The following specifications are based on Urethane Polymers International products to establish quality.
- B. Other acceptable manufacturer's systems shall be equivalent.

2.3 WATERPROOFING MATERIALS

WATERPROOFING 07110-5

- A. WP-1 (for vertical and horizontal surfaces below grade, masonry backer walls and inside planters): Single component, fluid-applied, modified elastomeric waterproof membrane, UPI System BG-7011-90 Mill by Urethane Polymers or approved equal, 90 mils thickness for walls and vertical surfaces.
- B. WP-2 (for horizontal roof slabs supporting earth or paving and split slab construction): UPI System BG-7011-R-90 Mill or approved equal.
- C. WP-3 (for exposed concrete parking and vehicular traffic decks): Single component, moisture-curing, polyurethane elastomeric membrane UPI Uradek System #70-S for parking stalls; Uradek System #70-H or approved equal for entrances, ramps and drives.
- D. Caulking Compound: Single component, polyurethane as recommended by the primary waterproofing materials manufacturer.
- E. Aggregate: As recommended by the manufacturer and approved by the Owner's representative.
- F. Other materials as recommended by the manufacturer of the prime materials.

2.4 PROTECTION / DRAINAGE BOARD

- A. Composite structure of a molded, three-dimensional, high impact-resistant polymeric sheet with a filler fabric bonded to the open side. ACCW MiradRAIN 6000" as manufactured by Carlisle Coatings or approved equal.

- 1. Attach panels to the substrate with an adhesive recommended by the manufacturer.

2.5 MISCELLANEOUS MATERIALS

- A. Parge Coat: Where the manufacturer requires a portland cement parge coat over rough or porous substrates, the Contractor shall provide such parge coat as required at no additional cost. Failure of the parge coat or the absence of a parge coat will be considered as failure of the membrane system to perform as the parge coat is a required condition for the membrane's success over substrates requiring a parge coat.

PART 3 EXECUTION

3.1 EXAMINATION

- A. Section 01700 - Execution Requirements: Verification of existing conditions before starting the work.
- B. Verification of Conditions: Verify that field measurements, surfaces, substrates and conditions are as required, and ready to receive the work.
  1. Verify that joint sealants are installed and cured.
  2. Verify that surfaces to be coated are dry, clean, and free of efflorescence, oil, and other matter detrimental to application of the coating.
- C. Report, in writing, prevailing conditions that will adversely affect satisfactory execution of the work of this Section. Do not proceed with the work until the unsatisfactory conditions have been corrected.

WATERPROOFING 07110-6

3.2	<p><b>PREPARATION</b></p> <p>A. Clean substrate surfaces of projections and substances detrimental to the work, acid etch smooth surfaces, fill all voids to comply with recommendations of the prime materials manufacturer. Stripe coat all cracks up to 1/16" wide, rout and patch cracks larger than 1/16".</p> <p>B. <b>Moisture Content Testing:</b> Just prior to application, test substrates with an electronic moisture meter. Do not proceed until the moisture content is within the manufacturer's acceptable tolerances.</p> <p>C. <b>Protection of Other Work:</b> Do not allow liquid or mastic compounds to enter and clog drains, sleeves or conductors. Prevent spillage and migration onto other surfaces of the work by masking or otherwise protecting the adjoining work.</p>	<p>b. Cracks: Encapsulated reinforcement of a width necessary to extend the material 6", minimum, on each side of the crack.</p>
3.3	<p><b>INSTALLATION</b></p> <p>A. <b>General:</b> Comply with the manufacturer's instructions, except where more stringent requirements are shown or specified, and except where Project conditions require extra precautions or provisions to ensure satisfactory performance of the work.</p> <p>B. <b>Thickness Testing:</b> Monitor mil thickness application by a monitoring method recommended by the Manufacturer's Technical Representative for each specific system.</p> <p>C. <b>Reinforcement:</b> Unless otherwise acceptable, or as otherwise recommended, in writing, by the Manufacturer's Technical Representative, reinforcement is to be provided as follows and in the manner indicated:</p> <ol style="list-style-type: none"> <li>1. <b>Material:</b> Manufacturer's recommended elastomeric sheet and / or polyester fabric fully encapsulated in the primary membrane coating of a thickness equal to the total thickness required for the primary membrane, unless otherwise recommended by the manufacturer, and has been reviewed and approved on submittals.</li> <li>2. <b>Transitions:</b> At transitions from vertical to horizontal, at inside and outside corners, and at other similar transitions that are not expansion / control joints, penetrations, or cracks, embed reinforcement of a width that extends 6", minimum, onto each surface on each side of the intersection.</li> <li>3. <b>Expansion / Control Joints:</b> Embed reinforcement of a width necessary to extend the material 6", minimum, on each side of the joint, plus additional materials, as necessary, to accommodate movement of the joint. Small joints are to be bridged over backer rods placed in the joints. Reinforcement is to be looped down into the joints with backer rod placed in the loop.</li> <li>4. <b>Penetrations:</b> 36" square reinforcement, but not less than necessary to extend out in all directions from the penetration a distance of 12", minimum, beyond the flange of each penetration.</li> </ol> <p>a. <b>Pipes, Conduits, and Similar Components:</b> Construct a form fitting elastomeric boot 6", minimum, in height and with an integral elastomeric flange extending 6", minimum, onto the wall or deck. The boot shall be fully adhered to the penetrating element and fully encapsulated at the interface with the wall or deck. Apply 36" square reinforcement material over this, fully encapsulated in the primary membrane material.</p>	<p>1. <b>Attach Protection / Drainage Boards</b> to all vertical and horizontal surfaces with adhesive per the manufacturer's recommendations. Set panels with the fabric toward the earth side. Lap fabric a minimum of 2". Install at below grade walls and retaining walls. Lap fabric at the top of the highest course and embed in waterproofing to ensure that loose material cannot enter and accumulate behind the protection / drainage board. Backfill against boards with approved material.</p> <p>B. <b>WP-2:</b> Apply a surface conditioner to concrete substrates in accordance with the manufacturer's instructions. Apply membrane in three (3) applications at a rate to provide a continuous monolithic coating of 30 dry mils, average thickness per coat, and 90 mils total thickness. Provide flashing in accordance with the manufacturer's standard details. Where protection board is required, embed into the membrane to ensure good bond. Place protection boards in a staggered pattern and butt boards tightly together.</p> <p>C. <b>WP-3:</b> Prime and apply a 30 mil thick coating to cover and overlap shrinkage cracks, integral flashings, caulked expansion joints and construction joints. Apply a 25 mil base coat, 25 mil intermediate coat, and two (2) 10 mil top coats to produce 70 mils total thickness, exclusive of aggregate. Broadcast aggregate in the first top coat.</p>
3.4	<p><b>APPLICATION</b></p> <p>A. <b>WP-1:</b> Prime coat the substrate surface at the rate of 250 - 300 sq. ft. / gallon. Apply with rollers, two or more coats (30 dry mils) at the rate of 4.5 gallons / 100 sq. ft. to produce 90 dry mils total thickness at vertical surfaces. Allow 18 hours curing time between coats.</p>	<p>2. <b>Method of Containment:</b> Dams, seals, and other methods used to contain water should be capable of fully containing water for the period of time required. The method of containment should not damage the adjacent work.</p> <p>E. <b>Period of Containment:</b> 48 hours without loss of water, except for that by natural evaporation, and without evidence of failure in the membrane in any manner.</p> <p>F. <b>Report:</b> Submit a report of tests to the Owner's representative indicating the location of the test, date and time of the test, weather conditions and results.</p>
3.5	<p><b>MEMBRANE TESTING</b></p> <p>A. <b>Water Test:</b> Conduct water containment tests to ensure that the membranes are watertight.</p> <p>B. <b>Horizontal Membranes:</b> For installations where the primary membrane is horizontal, contain waterproofed areas in a manner to prevent 2", minimum, depth of water from escaping by damming any open perimeters and sealing the drains.</p> <p>C. <b>Pan Membranes:</b> For installations where the primary membrane forms a continuous container with the bottom and all vertical sides enclosed, such as planters, seal the drains and fill the container to within 1" of the top termination of the membrane.</p>	<p>3. <b>PROTECTION</b></p> <p>A. <b>Contractor's Operations:</b> The Contractor to verify the kinds of operations that will be conducted around or over installed membranes. The Owner's representative will advise the Contractor of the measures that must be implemented to ensure that the membranes will be without damage at the time of Substantial Completion.</p>
3.6	<p><b>WATERPROOFING</b></p> <p style="text-align: right;">07110-7</p>	<p><b>WATERPROOFING</b></p> <p style="text-align: right;">07110-8</p>

- B. Buried Installations: At the time of backfill / fill, at the time of installation of irrigation and landscaping over buried membranes, and at any other time where the Contractor's operations may have an adverse effect on a buried membrane system, the Manufacturer's Technical Representative shall observe to ensure that the Contractor's operations are being conducted in a manner that will protect the membranes from damage.

3.7 FIELD QUALITY CONTROL

- A. Section 01450 - Quality Control: Field inspection.
  - B. Inspect installations for tight and waterproof joints and proper thickness of membrane applications.
- 3.8 CLEANING
- A. Section 01700 - Execution Requirements: Cleaning the installed work.
  - B. Clean all spills. Do not leave splatters or drips.
  - C. Do not allow seepage of waterproofing through joints.

END OF SECTION

SECTION 07120  
FLUID-APPLIED URETHANE ROOFING

PART 1 GENERAL

1.1 SUMMARY

- A. Section Includes:
  - 1. Fluid-applied, elastomeric polyurethane membrane roofing system for new and existing, exposed concrete roof slabs.
  - 2. Walking surfaces over concrete roof slabs.
- B. Related Documents: The Contract Documents, as defined in Section 01010 - Summary of Work, apply to the work of this Section. Additional requirements and information necessary to complete the work of this Section may be found in other Documents.
- C. Related Sections:
  - 1. Section 03300 - Cast-In-Place Concrete: Substrate for roofing materials.

1.2 DESCRIPTION OF WORK

- A. The extent of fluid-applied waterproofing over new and existing concrete roof slabs, including walking surfaces is indicated on the Drawings and as specified herein, and includes providing and applying all the required products.

1.3 REFERENCES

- A. The publications listed below form a part of this Specification to the extent referenced. Publications are referred to in the text by basic designation only.
  - 1. ASTM C 501 - Test Method for Relative Resistance to Wear of Unglazed Ceramic Tile by the Taber Abraser.
  - 2. ASTM C 957 - Specification for High-Solids Content, Cold Liquid-Applied Elastomeric Waterproofing Membrane With Integral Wearing Surface.
  - 3. ASTM D 412 - Test Methods for Vulcanized Rubber and Thermoplastic Elastomers - Tension.
  - 4. ASTM D 624 - Test Methods for Tear Strength of Conventional Vulcanized Rubber and Thermoplastic Elastomers.
  - 5. ASTM D 822 - Practice for Filtered Open-Flame Carbon-Arc Exposures of Paint and Related Coatings.
  - 6. ASTM D 903 - Test Method for Peel or Stripping Strength of Adhesive Bonds.
  - 7. ASTM D 1004 - Test Method for Tear Resistance (Graves Tear) of Plastic Film and Sheeting.
- B. American Society for Testing and Materials (ASTM):

WATERPROOFING

07110-9

FLUID-APPLIED URETHANE ROOFING

07120-1

- 8. ASTM D 2240 - Test Method for Rubber Property - Durometer Hardness.
  - 9. ASTM E 96 - Test Methods for Water Vapor Transmission of Materials.
- C. National Roofing Contractors Association (NRCA):
- 1. Roofing and Waterproofing Manual.
- D. Underwriters Laboratories Inc.:
- 1. UL 790 - Test Method for Fire Test of Roof Coverings.
- E. U. S. Environmental Protection Agency (EPA):
- 1. Method 24 - Determination of Volatile Matter Content

1.4 SUBMITTALS

- A. Section 01330 - Submittal Procedures: Procedures for submittals.
- 1. Product Data: Provide data for primer, membrane roofing, flexible flashings, joint and crack sealants and temperature range for application of the waterproofing membrane.
  - 2. Shop Drawings: Sequence drawings and details for special conditions not covered by the manufacturer's standard details.
  - 3. Samples: Not less than 6" x 6" in size showing the applied thickness, texture and color.
  - 4. Manufacturer's Installation Instructions: Indicate special procedures and perimeter conditions requiring special attention.
  - 5. Assurance / Control Submittals:
    - a. Manufacturer's certificate that the products meet or exceed the specified requirements.
    - b. Manufacturer's Material Safety Data Sheets (MSDS).
    - c. Manufacturer's certification that the products supplied comply with applicable federal and local regulations controlling the use of volatile organic compounds (VOC).
    - d. Manufacturer's instructions indicating procedures and conditions requiring special attention, and cautionary procedures required during application.
    - e. Documentation of experience indicating compliance with the specified qualifications requirements.
- B. Section 01760 - Closeout Submittals: Procedures for closeout submittals.
- 1. Warranty: Submit a written special Warranty with forms completed in the name of the Owner and registered with the manufacturer.

1.5 QUALITY ASSURANCE

FLUID-APPLIED URETHANE ROOFING 07120-2

- A. Qualifications:
- 1. Manufacturer: Company specializing in manufacturing aromatic and aliphatic urethane roofing systems materials with a minimum of five (5) years documented experience in high temperature, high UV and high humidity environments.
  - 2. Authorized Applicator: Company specialized in, and has successfully completed applications of the same or similar type of materials for not less than five (5) years.
    - a. Applicator shall be specifically approved as a factory-authorized Applicator, in writing, by the roofing system manufacturer.
    - b. Submit the manufacturer's written approval and certification of the Applicator.
    - c. Applicator's equipment and training shall conform to the manufacturer's standards.
    - d. As applicable, assign work closely associated with waterproofing, including, but not limited to, waterproofing accessories, flashing in connection with waterproofing, expansion joints in membranes, and insulation and protection courses in membranes, to the waterproofing Applicator for undivided responsibility.
    - e. Applicator shall conform strictly to the manufacturer's Quality Assurance Programs requirements.
- B. Source Quality Control: Obtain the primary waterproofing materials from a single manufacturer. Provide secondary materials only as recommended by the primary materials manufacturer.
- C. Manufacturer's Technical Representative:
- 1. The primary waterproofing materials manufacturer to make a Technical Representative available to monitor the on-going work to ensure proper application of the roofing system. The manufacturer must maintain the same Technical Representative for the duration of the Project.
  - 2. Pre-Application Review: Prior to the start of work and the purchase of any materials, the Manufacturer's Technical Representative, who is to certify each application, shall visit the Project Site, review existing conditions, and review the Contract Document for appropriateness of the requirements with the specified manufacturer's system including, but not necessarily limited to, the substrate and application conditions.
  - 3. Certification: After the Manufacturer's Technical Representative's review, submit written certification of the appropriateness of the requirements, or submit other or additional specific recommendations, if any, to assure that the specified system is appropriate for the use intended and complete in scope to ensure its intended performance. This should be coordinated with the Shop Drawing Submittal.
  - 4. Substrate Certification: Submit the Technical Representative's written certification of compliance that the prepared substrate is in conformance with requirements necessary for application of the system. Inspection and certification of the substrate is to be accomplished just prior to the start of application of the membrane system.

FLUID-APPLIED URETHANE ROOFING 07120-3

5. Technical Representative's Field Review of Work:

- a. Number of Site Visits: Submit the manufacturer's recommended minimum number of times the Technical Representative is to field review the work to ensure success of the application. Indicate the stages of work when such visits are to be made.
- b. Field Reports: For each visit, the Technical Representative shall submit a detailed Field Report assessing each application. Field Reports to indicate the date, time of day, length of each visit, weather conditions during the visit, condition of the substrate at the time of application, application procedures, and other important aspects that affect success of the application. Submit Reports within seven (7) days after each Site visit.
- D. Regulatory Requirements: Comply with the applicable rules and regulations of the EPA and the local pollution control regulatory agency having jurisdiction regarding volatile organic compounds (VOC) and the use of hydrocarbon solvents.
- E. Performance Requirements: It is required that the fluid-applied waterproofing membrane be watertight, and not deteriorate in excess of the limits published by the membrane manufacturer.
- F. Caution: Do not apply fluid-applied waterproofing membrane to on-grade slabs, split slabs with buried membrane or on slabs over unvented metal pans without prior approval of the roofing membrane manufacturer.

1.6 COORDINATION

- A. Pre-Application Conference: Prior to start of the application of materials, meet at the Project Site with the Owner's representative, Architect, Contractor, Applicator and subcontractors whose work penetrates the surfaces to be roofed. Review the conditions, methods and procedures necessary for application of the work, including inspection of the areas of work, requirements of the Specifications and the manufacturer's literature; review submittals and schedules.

1.7 DELIVERY, STORAGE AND HANDLING

- A. Section 01600 - Product Requirements: Transport, handle, store, and protect the products.
- B. Deliver products to the Project Site in the manufacturer's original, new and unopened packages and containers with seals and labels intact; dry and undamaged, bearing the product name, color, manufacturer's lot number, directions for use and precautionary labels.
- C. Store materials not in actual use, in tightly covered containers. Maintain containers used in the storage of materials, in a clean condition, free of foreign materials and residue.
- D. Store materials in a well ventilated area, and in compliance with the manufacturer's written instructions.
- E. Keep storage areas neat and orderly. Remove waste daily.
- F. Protect against fire hazards and spontaneous combustion.
- G. Take all precautions to ensure that workmen and the work areas are adequately protected from health hazards resulting from handling, mixing and application of the materials.

1.8 JOB CONDITIONS

FLUID-APPLIED URETHANE ROOFING 07120-4

- A. Proceed with the work only after the substrate construction and penetrating work has been completed.
- B. Proceed with the work only when existing and forecasted weather conditions will permit work to be performed in accordance with the manufacturer's recommendations. Do not apply products under the following conditions:
  - 1. Substrate surfaces have cured less than thirty (30) days.
  - 2. Rain is predicted within 24 hours.
  - 3. Surfaces have not been dry for a minimum of 24 hours.
- C. Provide adequate ventilation to prevent the accumulation of hazardous fumes during the application of solvent-based components in enclosed spaces; maintain ventilation until the coatings have thoroughly cured.
- D. Warn personnel against breathing vapors and contact of materials with the skin and eyes.
- E. Ensure that workmen wear the appropriate approved respiratory gear and protective clothing.
- F. Ensure that all gas flames and electrical apparatus are shut down during the coating application and curing.

1.9 SAFETY / COORDINATION

- A. All application, material handling and associated equipment shall conform to, and be operated in conformance with OSHA safety requirements.
- B. Manufacturer's Material Safety Data Sheets (MSDS) shall be read, understood and the instructions adhered to.
- C. A sufficient number of filled and operating fire extinguishers meeting current standards must be on the roof deck at all times during application of the roofing materials.

1.10 WARRANTY

- A. Section 01780 - Closeout Submittals: Procedures for closeout submittals.
- B. Special Warranty:
  - 1. Provide a written joint and severable Warranty signed by the roofing materials manufacturer, Contractor and Applicator, agreeing to repair or replace defective materials and workmanship, defined to include leakage of water, ruptures caused by cracking substrate up to 1/16", abnormal aging or deterioration of materials, and other failures of the membrane to perform as required within the warranty period. Warranty shall include responsibility for removal and replacement of other work which conceals the membrane waterproofing.
  - 2. During the warranty period, repairs and replacements required because of acts of God and other events beyond the Contractor's / Applicator's control, and those which exceed the performance requirements, shall be completed by the Contractor / Applicator and paid for by the Owner at the prevailing rates.
  - 3. Warranty Period: Five (5) years from the date of Substantial Completion of the

FLUID-APPLIED URETHANE ROOFING 07120-5

roofing work.

Adhesion to Base Coat 30 pli ASTM D 903

D. Top Coat: UI-7016-HS, single-component, high tensile strength, abrasion-resistant, weather-resistant, aliphatic polyurethane. Meet or exceed the following typical performance properties:

## PART 2 PRODUCTS

### 2.1 MANUFACTURERS

- A. Subject to compliance with the Project requirements, manufacturers offering products which may be incorporated into the work include the following:
1. Urethane Polymers International, Inc.
  2. Carlisle Coatings & Waterproofing.
- B. Section 01600 - Product Requirements: Product Options: Substitutions not permitted.

### 2.2 SYSTEM

- A. The following specifications are based on Urethane Polymers International, ΔM-C-Thane 4556 - 60 Mil® system to establish quality.
- B. Other acceptable manufacturer's systems shall be equivalent.

### 2.3 ELASTOMERIC ROOFING MATERIALS

- A. Primer: UI-7012 water-based, or UI-7112 solvent-based, Epoxy-Polyamide, low viscosity, two-component primer / sealer, as recommended by the membrane manufacturer.
- B. Base Membrane: UI-7013 single-component, high-adhesion, moisture-cured, polyurethane membrane. Meet or exceed the following typical properties:

Property	Typical Value	Test Method
Composition	Aromatic Urethane	
Weight Solids	86 +/- 2%	
VOC Content	Less than 200 gm / l	
Hardness, Shore A	65 +/- 5	ASTM D 2240
Tensile Strength	900 +/- 100 psi	ASTM D 412
Ultimate Elongation	650 +/- 100%	ASTM D 412
Tear Resistance	150 +/- 25 lbs / in.	ASTM D 1004
Weather Resistance	Slight checking@ 500 hours	ASTM D 822
Adhesion to Concrete	30 pli	ASTM D 903

- C. Elastomeric Membrane: UI-7013-HT, single component high tensile strength, moisture-cured, liquid elastomeric polyurethane. Meet or exceed the following typical properties:

Property	Typical Value	Test Method
Composition	Aromatic Urethane	
Weight Solids	81 +/- 2%	
VOC Content	Less than 250 gm / l	
Hardness, Shore A	80 +/- 5	ASTM D 2240
Tensile Strength	2500 +/- 250 psi	ASTM D 412
Ultimate Elongation	450 +/- 50%	ASTM D 412
Tear Resistance	250 +/- 50 lbs / in.	ASTM D 1004
Weather Resistance	Slight chalk @ 1,000 hrs.	ASTM D 822

FLUID-APPLIED URETHANE ROOFING 07120-6

FLUID-APPLIED URETHANE ROOFING 07120-7

Property	Typical Value	Test Method
Composition	Aliphatic, Saturated Polyester Urethane	
Weight Solids	75 +/- 2%	
VOC Content	Less than 250 gm / l	
Hardness, Shore A	90 +/- 5	ASTM D 2240
Tensile Strength	3500 +/- 300 psi	ASTM D 412
Ultimate Elongation	250 +/- 50%	ASTM D 412
Tear Resistance	300 +/- 50 lbs / in.	ASTM D 1004
Water Permeability	Less than 0.1 Perm	ASTM E 96 / E 96M
Weather Resistance	No chalking @ 2000 hrs.	ASTM D 822
Abrasion Resistance	Negligible change, CS-17 wheels, 1000 cycles, 1,000 gm. load	
Color	White, or as selected	ASTM C 501

### 2.4 ACCESSORIES

- A. Flexible Flashing: 45-60 mils, thickness neoprene sheet or non-woven reinforcing fabric, or as recommended by the roofing materials manufacturer.
- B. Embedded Flashing / Reinforcing: Non-woven fabric as recommended by the roofing materials manufacturer.
- C. Joint and Crack Sealant: One- or two-component polyurethane compound, as recommended by the roofing membrane manufacturer.
- D. Caulking Compound: One- or two-component polyurethane compound as approved by the roofing membrane manufacturer.
- E. Aggregate: Rounded, non-angular, pre-blended 20 / 30 mesh, flint, shot silica, ground glass, Monterey sand, or equivalent washed and kiln-dried aggregate, free of foreign materials; hard and stable to atmospheric conditions.

## PART 3 EXECUTION

### 3.1 EXAMINATION

- A. Section 01700 - Execution Requirements: Verification of existing conditions before starting the work.
- B. Verification of Conditions: Verify that field measurements, surfaces, substrates and conditions are as required, and ready to receive the work.
1. Roofing Applicator, Manufacturer's Technical Representative and the Owners Representative must jointly examine the substrates and conditions under which the roofing work is to be done.
  2. Verify that substrate surfaces are durable, free of matter detrimental to adhesion

- and application of the roofing materials.
3. Verify that substrate surfaces are smooth, free of honeycomb and pitting, and not detrimental to full contact bond of the waterproofing materials.
  4. Verify that items which penetrate surfaces to receive the roofing are installed and secured in-place.
- C. Report, in writing, prevailing conditions that will adversely affect satisfactory execution of the work of this Section. Do not proceed with the work until the unsatisfactory conditions have been corrected.

### 3.2 CONDITION OF CONCRETE SURFACES

- A. Concrete surfaces shall have a steel troweled finish, free of fins, ridges, voids and air entraining holes.
- B. Cured at least 28 days or until completely dry by the water curing method. Curing compounds or chemical curing agents shall not be used without prior approval of the roofing manufacturer.
- C. Surfaces shall be sloped for proper drainage.
- D. Saw-cut control joints and / or expansion joints shall have been properly installed at strategic locations throughout the field of the deck.
- E. Required crickets and drains shall be cast monolithic with the main roof deck.
- F. Concrete decks poured over precast A.T.<sup>SM</sup>, planks or slabs, shall have control joints placed directly over all corresponding joints and openings in the precast units.
- G. Coordinate with Section 03300 - Cast-In-Place Concrete.

### 3.3 PREPARATION

- A. Finish voids, rock pockets and excessively rough surfaces with epoxy grout or grind to match the unrepared areas.
- B. Apply bond breaker per the manufacturer's recommendations, fill voids and seal joints with polyurethane sealant; pay particular attention to construction joints.
- C. Clean, prime, install backing rod and caulk all expansion and contraction joints with elastomeric polyurethane sealant.
- D. Repair of concrete cracks and spalls:
  1. All cracks over 1/16" in width and all moving cracks less than 1/16" in width shall be routed out to 1/4" minimum, width and depth, and filled flush with polyurethane elastomeric sealant.
  2. Joints less than 1/2" in width and all caulked cracks shall be stripe-coated with a 30 mil preparatory coat of Base Membrane for a width of 3" on either side of the crack.
  3. Apply 45 to 60 mil thick neoprene flashing or non-woven reinforcing fabric over all cracks as recommended by the membrane manufacturer.
- E. Treatment of Roof Penetrations:

FLUID-APPLIED URETHANE ROOFING 07120-8

1. Caulk around and along the perimeters of duct and pipe penetrations with polyurethane elastomeric sealant.
  2. Apply a 3/4" cant of sealant around all pipes, drains and vertical junctions.
  3. Apply 30 mils of polyurethane membrane coating 6" vertically, 6" horizontally on surfaces around roof penetrations.
- F. Correct ponding water locations for smooth flow into roof drains; use epoxy topping where required to build up slopes.
- G. Clean concrete substrate of projections and substances detrimental to the work.
- H. Thoroughly clean and dry concrete surfaces free of laitance, surface contaminants and cleaning residue. Clean and prepare surfaces to receive roofing in accordance with the manufacturer's published instructions.
- I. Protect adjacent surfaces not scheduled to receive roofing. Mask off surfaces to effectively prevent spillage and overspray of liquid materials outside the membrane area.
- J. Protect landscaping, property, personnel and vehicles from over spray and drift.

### 3.4 FLASHING REINFORCEMENT

- A. Install all required metal and neoprene flashings and fabric flashing reinforcement; install all sealant cants.
- B. Deliver all metal shop primed, then field prime with Epoxy Primer prior to coating with the Base Membrane. Prime metal surfaces which exhibit adhesion difficulties first with a zinc chromate type of epoxy primer.
- C. Base Membrane is used as an adhesive for polyester reinforcing fabric. Reinforcing fabric shall be laid into wet Base Membrane with roller, brush or broad blade knife. Fabric shall be laid relaxed, smooth and wrinkle-free; over-coat with Base Membrane.
- D. Coat flashings and polyester reinforcing fabric with Base Coat and Top Coat with each application.

### 3.5 APPLICATION

- A. The roofing Applicator shall have the sole right of access to specific areas of the roof for the time required to complete the application and to effect adequate cure.
- B. Comply with the manufacturer's instructions, except where more stringent requirements are shown or specified, and except where the Project conditions require extra precautions or provisions to ensure satisfactory performance of the work.
- C. Start application of the waterproofing membrane only in the presence and with the advice of the Manufacturer's Technical Representative.
- D. Stir and mix separately packaged components using a mixing paddle on a slow speed drill motor, in accordance with the manufacturer's instructions. Protect the components from sun and rain.
- E. Apply uniform coatings of waterproofing to substrates and surfaces indicated to receive membrane.

FLUID-APPLIED URETHANE ROOFING 07120-9



- F. Apply coatings by spray, squeegee or roller.
- G. Primer:
  1. Apply Primer at the approximate rate of 250 sq. ft. per gallon. Allow primer to dry until tack-free. Within 16 hours of primer application, apply Base Coat. If the base coat cannot be applied within 16 hours then re-prime the surfaces.
- H. Base Membrane:
  1. Apply Base Membrane in one uniform coat at the rate of 60 to 65 sq. ft. per gallon, minimum, or as needed to obtain a minimum dry film thickness of 20 mils. Allow 16 to 48 hours curing time before applying the next coat. Do not apply coating over joints greater than 1/2" in width.
- I. Elastomeric Membrane:
  1. Apply in one uniform coat at the approximate rate of 60 to 65 sq. ft. per gallon, minimum, or as needed to obtain an average dry film thickness of 18 mils. Allow 16 hours curing time before applying the next coat.
  2. If the preceding layers of membrane become dirty or contaminated or lose their surface tack, wipe clean with xylene immediately before applying the next coating.
  3. Apply a second coat of Elastomeric Membrane in one uniform coat at the rate of 100 sq. ft. per gallon, or as needed to obtain an average dry film thickness of 12 mils.
  4. At locations shown on the Drawings, or if not shown, as directed, while the second coat is still fluid, uniformly broadcast aggregate onto the coating at the rate of 25 lbs. per 100 sq. ft.
  5. Allow 16 to 36 hours curing time before applying the next coat.
- O. Permit the membrane to cure under conditions which will not contaminate or deteriorate the waterproofing materials. Block off all traffic and protect the membrane from physical damage.
- P. Remove protective coverings.

3.6 FIELD QUALITY CONTROL

- A. Section 01450 - Quality Control: Field inspection and testing.
- B. Inspect the fluid-applied roofing application.
- C. Test for required dry film thickness.

3.7 PROTECTION

- A. Section 01700 - Execution Requirements: Protection of the applied work.
- B. Do not permit traffic on the membrane during the first 24 hours after application and no heavy traffic within four (4) days after the final coat has been applied, or until accepted by the Owner's representative.
- C. Do not permit traffic over unprotected or uncovered membrane.

END OF SECTION

- K. Spray coats over flashings; embed with fabric when plastic flashings are spanning voids greater than 3/4".
- L. The application of membrane waterproofing materials shall be continued up onto vertical surfaces 6", minimum, and over the tops of fascias and parapets. Apply extra thickness waterproofing material at corners, intersections, angles, cants, penetrations and over cracks.
- M. If waterproofing is applied on unscheduled surfaces, remove immediately by a method approved by the membrane manufacturer.
- N. The overall dry film thickness of the completed waterproofing system, exclusive of aggregate, shall average 60 mils.
- J. Top Coat:
  1. Apply one uniform coat at the rate of 100 sq. ft. per gallon, minimum, to obtain an average dry film thickness of 10 mils, and to completely encapsulate the aggregate.
  2. For walkway surfaces and around roof-mounted equipment, provide aggregate additive for a tough non-slip surface. Apply in colors and patterns as designated by the Architect.

SECTION 07190

WATER REPELLENTS (SEALER)

PART 1 GENERAL

1.1 SUMMARY

A. Section Includes:

1. Surface preparation and application of clear penetrating water repellent coating to the following exposed surfaces:

- a. WR-1: Exterior and interior concrete walks and floors.
- b. WR-2: Slurry coating for dampproofing vertical walls.

B. Related Documents: The Contract Documents, as defined in Section 01010 - Summary of Work, apply to the work of this Section. Additional requirements and information necessary to complete the work of this Section may be found in other Documents.

C. Related Sections:

- 1. Section 03300 - Cast-in-Place Concrete: Sealers and curing agents.
- 2. Section 04400 - Natural Stone: Sealers and curing agents.
- 3. Section 07900 - Joint Sealers: Joint fillers and sealers.
- 4. Division 7 Sections - Roofing and Waterproofing.

1.2 DESCRIPTION OF WORK

A. The extent of each type of waterproofing work is indicated on the Drawings and as specified herein, and includes providing and applying waterproofing on concrete surfaces. Similar work used as an exposed finish is excluded by definition and, if required, is specified as roofing, flooring, special coating or other appropriate category.

1.3 REFERENCES

- A. The publications listed below form a part of this Specification to the extent referenced. Publications are referred to in the text by basic designation only.
- B. American Society for Testing and Materials (ASTM):
  - 1. ASTM C 642 - Test Method for Water Absorption.
  - 2. ASTM D 56 - Test Method for Flash Point by Closed Cup Tester.
  - 3. ASTM D 3960 - Practice for Determining Volatile Organic Compound (VOC) Content of Paints and Related Coatings.
  - 4. ASTM E 514 - Test Method for Water Penetration and Leakage Through Masonry.
- C. U. S. Environmental Protection Agency (EPA):

WATER REPELLENTS (SEALER)

07190-1

1. Method 24 - Determination of Volatile Matter Content.

1.4 SUBMITTALS

A. Section 01330 - Submittal Procedures: Procedures for submittals.

- 1. Product Data: Manufacturer's specifications, recommendations for water repellents for each surface specified, surface preparation and application instructions, precautions for materials which can contaminate the system, limitations to coating, protection and cleaning instructions. Include recommendations for sealing penetrations, cracks and control, construction and expansion joints. Submit color charts for products required to be integrally colored.
- 2. Shop Drawings: Indicate details critical to water tightness of the membrane, including, but not necessarily limited to, membrane transitions / terminations at perimeters, drains, sleeves and other penetrating elements.
- 3. Samples: 16" x 16" samples of each substrate indicated to receive water repellent with the specified repellent treatment applied to half of each sample.
- 4. Assurance/Control Submittals:

- a. Manufacturer's certification that the materials specified are recommended by the manufacturer for the applications indicated.
- b. Manufacturer's certificate that the products meet or exceed the specified requirements.
- b. Manufacturer's Material Safety Data Sheets (MSDS).
- c. Manufacturer's certification that the products supplied comply with applicable federal and local regulations controlling the use of volatile organic compounds (VOC).
- d. Manufacturer's instructions indicating procedures and conditions requiring special attention, and cautionary procedures required during application.
- e. Documentation of experience indicating compliance with the specified qualifications requirements.

B. Section 01780 - Closeout Submittals: Procedures for closeout submittals.

- 1. Warranty: Submit a written special Warranty with forms completed in the name of the Owner and registered with the manufacturer.

1.5 QUALITY ASSURANCE

A. Qualifications:

- 1. Manufacturer: Company specializing in manufacturing the products specified with a minimum of five (5) years documented experience, and has a record of successful in-service performance.
- 2. Applicator: Company experienced in applying the types of waterproofing required for this Project for not less than five (5) years, and is acceptable to the primary waterproofing materials manufacturer.

WATER REPELLENTS (SEALER)

07190-2

replace defective materials and workmanship, defined to include leakage of water, ruptures caused by cracking substrate up to 1/16", abnormal aging or deterioration of materials, and other failures of membranes to perform as required within the warranty period. Warranty shall include responsibility for removal and replacement of other work which conceals the waterproofing membrane.

2. During the warranty period, repairs and replacements required because of acts of God and other events beyond the Contractor's / Applicator's control, and those which exceed the performance requirements, shall be completed by the Contractor / Applicator and paid for by the Owner at the prevailing rates.

3. Warranty Period: Five (5) years from the date of Substantial Completion of the water repellent work.

**PART 2 PRODUCTS**

**2.1 MANUFACTURERS**

- A. Subject to compliance with the Project requirements, manufacturers offering products which may be incorporated into the work include the following:
  - 1. Tammis Industries.
  - 2. Hydrozo, Inc.
  - 3. Thoro System Products.
  - 4. Textured Coatings of America.
  - 5. Pecora Corp.
- B. Section 01600 - Product Requirements: Product Options: Substitutions permitted.

**2.2 MATERIALS**

- A. WR-1: Silane, clear, penetrating water repellent. A monomeric compound containing approximately 40% alkylalkoxysilane with alcohol, ethanol, mineral spirits, water, or other proprietary solvent carrier.
  - 1. Baracade Silane 40 by Tammis Industries.
  - 2. Concrete and Masonry Sealer by Thoro Consumer Products.
  - 3. Hydrozo Silane 40 VOC by Hydrozo, Inc.
  - 4. Kiere-Seal 940S VOC by Pecora Corp.
  - 5. Rainstopper RS1750W by Textured Coatings of America.
- B. WR-2: Crystalline, applied as a slurry coat.
  - 1. Xypex Concentrate by Xypex Chemical Corp. or approved equal.

**PART 3 EXECUTION**

WATER REPELLENTS (SEALER) 07190-4

B. Mockup: Apply water repellent to a mockup, either partial or full coverage, as directed, before proceeding with the application. Comply with the application requirements contained herein.

C. Regulatory Requirements: Comply with applicable rules and regulations of the pollution-control regulatory agency having jurisdiction regarding volatile organic compounds (VOC) and use of hydrocarbon solvents.

**1.6 DELIVERY, STORAGE AND HANDLING**

- A. Section 01600 - Product Requirements: Transport, handle, store, and protect the products.
- B. Deliver products to the Project Site in the manufacturer's original, new and unopened packages or containers with seals and labels intact, dry and undamaged, bearing the product name, color, manufacturer's lot number, directions for use and precautionary labels.
- C. Store materials not in actual use, in tightly covered containers. Maintain containers used in the storage of materials, in a clean condition, free of foreign materials and residue.
- D. Store materials in a well ventilated area, and in compliance with the manufacturer's published instructions.
- E. Store and handle materials to prevent deterioration and damage due to moisture, temperature changes, contaminants, and other causes.
- F. Protect against fire hazards and spontaneous combustion.
- G. Keep storage areas neat and orderly. Remove waste daily.
- H. Take all precautions to ensure that workmen and the work areas are adequately protected from health hazards resulting from handling, mixing and application of the materials.

**1.7 JOB CONDITIONS**

- A. Environmental Requirements: Do not apply products under any of the following conditions, except with the written recommendation of the manufacturer:
  - 1. Substrate surfaces cured less than thirty (30) days.
  - 2. Surfaces not dry for a minimum of 24 hours.
  - 3. Rain predicted within 24 hours.
  - 4. Windy conditions such that the repellent might be blown onto vegetation or onto substrates not intended to be coated.

**1.8 WARRANTY**

- A. Section 01780 - Closeout Submittals: Procedures for closeout submittals.
- B. Special Warranty:
  - 1. Provide a joint and severable written Warranty signed by the water repellent materials manufacturer, Contractor and the Applicator, agreeing to repair or

WATER REPELLENTS (SEALER) 07190-3

3.1

EXAMINATION

- A. Section 01700 - Execution Requirements: Verification of existing conditions before starting work.
- B. Verification of Conditions: Verify that the field measurements, surfaces, substrates and conditions are as required, and ready to receive work.
  - 1. Verify that joint sealants are installed and cured.
  - 2. Verify that surfaces to be coated are dry, clean, and free of efflorescence, oil, and other matter detrimental to application of the coating.
- C. Report, in writing, prevailing conditions that will adversely affect satisfactory execution of the Work of this Section. Do not proceed with the work until the unsatisfactory conditions have been corrected.

3.2

PREPARATION

- A. Clean substrate surfaces of substances that might interfere with penetration or performance of the water repellent. Remove loose particles and foreign matter. Remove oil and foreign substances with a cleaning agent which will not affect the coating.
- B. Scrub surfaces with water, rinse and let dry.
- C. Test for moisture content according to the manufacturer's instructions to ensure that the surfaces are sufficiently dry.
- D. Test the pH level according to the manufacturer's instructions to ensure chemical bond to the silicate minerals.
- E. Protect adjacent surfaces not scheduled to receive coating. Protect landscaping, property, and vehicles from over spray and drift. If applied on unscheduled surfaces, remove immediately, by an approved method.
- F. Prior to the start of application, properly seal joints and cracks in movement with an elastomeric joint sealant acceptable to the sealant manufacturer. Non-movement cracks greater than 1/64" in width must be filled with a suitable patching material.
- G. Do not apply water repellent until sealants in joints adjacent to surfaces to receive water repellent treatment have been installed and cured.

3.3

APPLICATION

- A. Prepare materials in accordance with the manufacturer's printed instructions for the Project conditions. Consult a manufacturer's technical representative if the printed recommendations are not applicable to the Project conditions.

- B. Apply coating in accordance with manufacturer's instructions, using the appropriate method and coverage rate.

C. WR-1:

- 1. Apply a heavy-saturation spray coating of the water repellent on surfaces indicated for treatment using low-pressure spray equipment. Comply with the manufacturer's instructions and recommendations using airless spraying procedure unless otherwise indicated.
- 2. Apply a second saturation spray coating, repeating the first application. Comply with the manufacturer's instructions for limitations on drying time between coats and after rainstorm wetting of surfaces between coats.
- 3. Remove protective coverings from adjacent surfaces.

D. WR-2:

- 1. Mix Xype Concentrate in accordance with the manufacturer's instructions. Apply with a bristle-brush to a uniform thickness of 1/16".
- 2. Apply a second coat after the first coat has reached initial set but is still <sup>A</sup>green@.
- 3. Lightly re-water, as necessary, to counteract drying.
- 4. Wet cure surfaces in accordance with the manufacturer's instructions. Do not thoroughly wet concrete surfaces with water to saturate the surfaces; remove excess water before application.

3.4 FIELD QUALITY CONTROL

- A. Section 01450 - Quality Control: Field inspection.
- B. Inspect for complete and consistent coverage and waterproofing capability.

3.5 CLEANING

- A. Section 01700 - Execution Requirements: Cleaning the installed work.
- B. Clean all spills. Do not leave splatters or drips.

END OF SECTION

WATER REPELLENTS (SEALER)

07190-5

WATER REPELLENTS (SEALER)

07190-6

SECTION 07210  
BUILDING INSULATION

PART 1 GENERAL

1.1 SUMMARY

- A. Section Includes:
1. Semi-rigid insulation at underside of roofs at interior spaces.
  2. Board insulation for split slabs and under decks.
  3. Batt insulation at exterior stud walls of air conditioned spaces and at interior stud walls for sound control.
  4. Semi-rigid board insulation at shafts and chases.
  5. Exposed wall and ceiling insulation at Mechanical Rooms.
  6. Spray-applied thermal and acoustical insulation for exposed ceilings.

B. Related Documents: The Contract Documents, as defined in Section 01010 - Summary of Work, apply to the work of this Section. Additional requirements and information necessary to complete the work of this Section may be found in other Documents.

C. Related Sections:

1. Section 03300 - Cast-In-Place Concrete: Substrate for installation of insulation.
2. Section 09110 - Non-Load Bearing Steel Framing: Support for installation of insulation.

1.2 DESCRIPTION OF WORK

A. The extent of each type of building insulation is indicated on the Drawings and as specified herein, and includes providing and installing thermal, acoustical and spray-on insulation, and sealing and smoke stops.

1.3 REFERENCES

- A. The publications listed below form a part of this Specification to the extent referenced. Publications are referred to in the text by basic designation only.
- B. American Society for Testing and Materials (ASTM):
1. ASTM C 518 - Test Method for Steady-State Thermal Transmission Properties by Means of the Heat Flow Meter Apparatus.
  2. ASTM C 612 - Specification for Mineral Fiber Block and Board Thermal Insulation.
  3. ASTM C 665 - Specification for Mineral-Fiber Blanket Thermal Insulation for Light Frame Construction and Manufactured Housing.
  4. ASTM D 5113 - Test Method for Determining Adhesion Attack of Rigid Cellular Foam.

BUILDING INSULATION 07210-1

5. ASTM E 84 - Test Method for Surface Burning Characteristics of Building Materials.
6. ASTM E 119 - Test Method for Fire Tests of Building Construction and Materials.

1.4 SUBMITTALS

A. Section 01330 - Submittal Procedures: Procedures for submittals.

1. Product Data: Manufacturer's product specifications and installation instructions for each type of insulation and vapor barrier material required. Indicate product characteristics, performance criteria and limitations.
2. Assurance / Control Submittals:
  - a. Manufacturer's certificate that the products meet or exceed the specified requirements.
  - b. Documentation of experience indicating compliance with the specified qualifications requirements.

1.5 QUALITY ASSURANCE

A. Qualifications:

1. Manufacturer: Company specializing in manufacturing the products specified with a minimum of five (5) years documented experience.
2. Installer: Company experienced in performing the work of this Section with a minimum of five (5) years documented experience.
3. Use adequate number of skilled workmen, thoroughly trained and experienced in the necessary crafts and are completely familiar with the specified requirements and methods for proper performance of the work of this Section.

B. Regulatory Requirements: Conform to the flame spread and smoke developed requirements of the local authority having jurisdiction.

1.6 DELIVERY, STORAGE AND HANDLING

- A. Section 01600 - Product Requirements: Transport, handle, store and protect the products.
- B. Deliver products to the Project Site in the manufacturer's original, unopened packages, containers or bundles, bearing brand name, identification of the manufacturer, and material identification.
- C. Store inside, under cover, and in a manner to keep dry.
- D. Protect from weather, direct sunlight, moisture, surface contamination, and damage from construction traffic and other causes.

PART 2 PRODUCTS

2.1 MANUFACTURERS

BUILDING INSULATION 07210-2

- A. Subject to compliance with the Project requirements, manufacturers offering products which may be incorporated into the work include the following:
  1. CertainTeed.
  2. Owens-Corning.
  3. Dow Chemical.
  4. Manville-Schuller International.
  5. International Cellulose Corporation.
- B. Section 01600 - Product Requirements: Product Options: Substitutions permitted.

2.2 THERMAL INSULATION

- A. Concealed Glass Fiber Insulation Boards: Unfaced glass fiber thermal insulation, semi-rigid boards, friction-fit, 48" x 96" x 2-1/2" thick, R-13 or as indicated, ASTM C 612, Type 1A and 1B. Maximum flame spread rating 25, maximum smoke developed 50 when tested in accordance with ASTM E 84. <sup>Δ</sup>Type 703<sup>Δ</sup> by Owens-Corning or approved equal.
- B. Polystyrene Insulation Boards: High density extruded polystyrene foam insulation, 48" x 96" x 1-1/2" thick, R-5.6, square edge, 1/2" x 1/4" drainage channels on bottom long edge, for installation over waterproofing membrane. Plaza Deck STYROFOAM Brand PLAZAWATE Insulation by Dow Chemical Co.
- C. Concealed Wall Batt Insulation: Unfaced glass fiber thermal insulation, friction-fit, 16" or 24" widths as required x 3-1/2" thick, ASTM C 665, Type I, R-11 when tested in accordance with ASTM C 518. Maximum flame spread 10, maximum smoke developed 10 when tested in accordance with ASTM E 84. <sup>Δ</sup>Thermal Batt Insulation<sup>®</sup> by Owens-Corning or approved equal.

2.3 ACOUSTICAL INSULATION

- A. Concealed Noise Barrier Batt Insulation: Unfaced glass fiber acoustical insulation, friction-fit, 16" or 24" widths as required x 3-1/2" thick, ASTM C 665, Type I. Maximum flame spread 10, maximum smoke developed 10 when tested in accordance with ASTM E 84. <sup>Δ</sup>Sound Attenuation Batts<sup>®</sup> by Owens-Corning or approved equal.
- B. Chase Wall Insulation: Unfaced glass fiber acoustical insulation, semi-rigid, friction-fit, 24" x 96" x 1-1/2", ASTM C 665, Type I, R-5.8 when tested in accordance with ASTM C 518. ASTM E 119 for 1-hour fire rated partitions. Maximum flame spread 20, maximum smoke developed 20 when tested in accordance with ASTM E 84 and UL 723. <sup>Δ</sup>Shaftwall Insulation<sup>®</sup> by Owens-Corning or approved equal.
- C. Exposed Generator Room Walls and Ceiling: FRK (foil) faced glass fiber thermal insulation, semi-rigid, 1-1/2" thick, ASTM C 612, Type 1A and 1B. Maximum flame spread 25, maximum smoke developed 50 when tested in accordance with ASTM E 84. <sup>Δ</sup>Type 703<sup>®</sup> by Owens-Corning or approved equal.

2.4 SPRAY-ON INSULATION

- A. Exposed Thermal-Acoustical Spray-Applied Cellulose: Textured fibered cellulose with chemical binder and adhesives, mildew and mold treated, spray-applied, 3" thick, R-4.5 per

BUILDING INSULATION 07210-3

- inch, NRC of 1.0, Class <sup>Δ</sup>A flame spread rating per ASTM E 84. FMRC Category I, <sup>Δ</sup>K-13<sup>®</sup> by International Cellulose Corp. or approved equal. Color as selected.
- B. Exposed Acoustical Spray Applied Cellulose: Textured fibered cellulose with chemical binder, mildew and mold treated, spray applied, NRC .90 at 1" thick, <sup>Δ</sup>K-13 fo<sup>®</sup> by International Cellulose Corp. or approved equal. Color as selected.

2.5 OTHER MATERIALS

- A. Insulation Anchors: Impaling pin-type with 2" diameter flat anchor head and wire spindles, self-locking holding washers; designed for adhesive application to the underside of roof decks. Adhesive as supplied or approved by the insulation manufacturer.
- B. Provide other materials, not specifically described but required for a complete and proper installation, as recommended by the insulation manufacturer.

PART 3 EXECUTION

3.1 EXAMINATION

- A. Section 01700 - Execution Requirements: Verification of existing conditions before starting the work.
- B. Verification of Conditions: Verify that the areas, surfaces, substrates and conditions are as required, and ready to receive the work.
  1. Board Insulation:
    - a. Verify that the substrate and adjacent materials are dry and ready to receive the insulation and adhesive.
    - b. Verify that the insulation boards are dry, unbroken and free of damage.
  2. Batt Insulation:
    - a. Verify that the adjacent materials are dry and ready to receive the installation.
    - b. Verify that mechanical and electrical services within the walls have been installed, are properly placed, and has been tested.
  3. Spray-applied Insulation:
    - a. Verify that the substrate and adjacent surfaces are dry and ready to receive the insulation.
    - b. Verify that all equipment is operating properly.

3.2 INSTALLATION

- A. Remove or protect against projections in the construction framing which might damage or prevent the proper installation or application of materials.
- B. Report, in writing, prevailing conditions that will adversely affect satisfactory execution of the work of this Section. Do not proceed with the work until the unsatisfactory conditions have been corrected.

BUILDING INSULATION 07210-4

A. Install the work of this Section in strict accordance with the original design, requirements of government agencies having jurisdiction, and the manufacturer's recommended installation procedures as approved. Anchor all components firmly into position.

### 3.3 INSTALLATION - ROOF INSULATION

A. Apply with stick pins, adhesively secured to the underside of the roof. Provide a minimum of 8 pins per 4' x 8' board and 6 pins per 4' x 4' board, spaced per the manufacturer's instructions. Butt all edges and ends of insulation tightly.

### 3.4 INSTALLATION - SPLIT SLABS AND UNDER DECKS

A. Set in an approved waterproof roof coating in accordance with the manufacturer's recommendations. Protect insulation from weathering, sunlight and traffic until the top deck has been placed.

### 3.5 INSTALLATION - WALL INSULATION

A. Install batt insulation in accordance with the manufacturer's instructions, without gaps or voids.

B. Wall insulation: Friction fit for installation within metal framing. Carry around water and waste piping, electrical junction boxes, outlets, conduit and other elements to ensure a complete acoustical barrier.

C. Trim insulation neatly to fit the spaces. Use batts free of damage. Fit insulation tight in the spaces and tight to the exterior side of mechanical and electrical services within the plane of the insulation.

D. When faced, install the insulation with the factory-applied membrane facing the warm side of the building space. Lap ends and side flanges of the membrane. Attach insulation in place to the framing. Tape seal butt ends and lapped side flanges. Tape seal tears and cuts in the membrane.

### 3.6 INSTALLATION - MECHANICAL ROOM WALLS AND CEILINGS

A. Install with impaling pins; bend prongs of pins inward so they are not a hazard. Tape joints. Stop insulation 4" from light fixtures and heat producing equipment.

### 3.7 INSTALLATION - SPRAY-APPLIED INSULATION

A. Apply by authorized applicator utilizing authorized fiber machines and nozzles for control of the fiber / binder ratio. Prime or seal surfaces before applying as required by the insulation manufacturer. Apply the manufacturer's standard fire-retardant mildew-resistant overspray.

### 3.8 FIELD QUALITY CONTROL

A. Section 01450 - Quality Control: Field inspection.

B. Inspect work for proper thickness, secure attachment to the substrate and in accordance with the manufacturer's instructions.

END OF SECTION

BUILDING INSULATION 07210-4

## SECTION 07620

### SHEET METAL FLASHING AND TRIM

#### PART 1 GENERAL

##### 1.1 SUMMARY

###### A. Section Includes:

1. Metal base flashings and counter flashings.

2. Penetration flashing.

3. Built-in metal scuppers.

4. Gutters.

5. Downspouts.

6. Miscellaneous sheet metal accessories.

B. Related Documents: The Contract Documents, as defined in Section 01010 - Summary of Work, apply to the work of this Section. Additional requirements and information necessary to complete the work of this Section may be found in other Documents.

###### C. Related Sections:

1. Section 03300 - Cast-in-Place Concrete: Substrate for securing flashing.

2. Section 04230 - Reinforced Unit Masonry: Substrate for securing flashing.

3. Section 07410 - Preformed Metal Roofing: Substrate for securing flashing.

##### 1.2 DESCRIPTION OF WORK

A. The extent of each type of flashing and sheet metal work is indicated on the Drawings and as specified herein, and includes providing and installing flashings, metal scuppers, gutters, downspouts and miscellaneous accessories.

##### 1.3 REFERENCES

A. The publications listed below form a part of this Specification to the extent referenced. Publications are referred to in the text by basic designation only.

B. American Iron and Sheet Institute (AISI):

1. North American Specification for the Design of Cold-Formed Steel Structural Members.

C. American Society of Civil Engineers (ASCE):

1. ASCE / SEI 7 - Minimum Design Loads for Buildings and Other Structures.

D. American Society for Testing and Materials (ASTM):

SHEET METAL FLASHING AND TRIM 07620-1

1. ASTM A 167 - Specification for Stainless and Heat-Resisting Chromium-Nickel Steel Plate, Sheet and Strip.
  2. ASTM A 361 - Steel Sheet, Zinc-Coated (galvanized) by the Hot-Dip Process for Roofing and Siding.
  3. ASTM A 527 / A 527M - Steel Sheet, Zinc-Coated (Galvanized) by the Hot-Dip Process, Lock-Forming Quality.
  4. ASTM A 653 - Specification for Steel Sheet, Zinc-Coated (Galvanized) or Zinc-Iron Alloy-Coated (Galvannealed) by the Hot-Dip Process.
  5. ASTM A 792 / A 792M - Specification for Steel Sheet, 55% Aluminum-Zinc Alloy-Coated by the Hot-Dip Process.
  6. ASTM B 32 - Specification for Solder Metal.
  7. ASTM B 209 - Specification for Aluminum and Aluminum-Alloy Sheet and Plate.
  8. ASTM B 221 - Specification for Aluminum and Aluminum-Alloy Extruded Bars, Rods, Wire, Profiles and Tubes.
  9. ASTM B 370 - Specification for Copper Sheet and Strip for Building Construction.
  10. ASTM B 486 - Specification for Paste Solder.
  11. ASTM C 920 - Specification for Elastomeric Joint Sealants.
- E. International Code Council:
1. International Building Code (IBC), 2009.
- F. Metal Building Manufacturer's Association (MBMA):
1. Metal Building Systems Manual.
- G. National Roofing Contractors Association (NRCA):
1. The NRCA Roofing and Waterproofing Manual.
- H. Sheet Metal and Air Conditioning Contractors National Association (SMACNA):
1. Architectural Sheet Metal Manual.
- I. Society for Protective Coatings (formerly Structural Steel Painting Council):
1. SSPC-Paint 12 - Cold-Applied Asphalt Mastic (Extra Thick Film).
- 1.4 SUBMITTALS
- A. Section 01330 - Submittal Procedures: Procedures for submittals.
1. Product Data: Manufacturer's product specifications, gauges and thickness, installation instructions and general recommendations for each specified sheet material and fabricated product.
2. Shop Drawings: Show layout, joining, profiles, and anchorage of fabricated work, including valley flashings, major counter flashings, trim / fascia units, gutters, downspouts, scuppers and expansion joint systems; layouts at 1/4" scale, details at 3" scale.
  3. Samples: Submit 8" square samples of the specified sheet materials that will be exposed as finished surfaces.
  4. Assurance / Control Submittals:
    - a. Manufacturer's certificate that the products meet or exceed the specified requirements.
    - b. Calculations indicating that the products and anchorage satisfies the performance requirements.
    - c. Documentation of experience indicating compliance with the specified qualifications requirements.
- B. Section 01780 - Closeout Submittals: Procedures for closeout submittals.
1. Warranty: Submit a written limited Warranty with forms completed in the name of the Owner and registered with the manufacturer.
- 1.5 QUALITY ASSURANCE
- A. Qualifications:
1. Fabricator: Company specializing in manufacturing the products specified with a minimum of five (5) years documented experience.
  2. Installer: Company experienced in performing the work of this Section with a minimum of five (5) years documented experience.
- 1.6 DESIGN AND PERFORMANCE CRITERIA
- A. Thermal Movement:
1. The completed metal roofing and flashing system shall be capable of withstanding expansion and contraction of components caused by changes in temperature without buckling, producing excess stress on the structure, anchors or fasteners, or reducing performance ability.
  2. The interface between panels and clips shall provide for a minimum of 3" of thermal movement in each direction along the longitudinal direction.
  3. The location of metal roofing rigid connectors shall be designed to meet the job conditions by the metal roof system manufacturer.
- B. Wind Load Requirements:
1. Provide the capacity to withstand the following loading requirements:
    - a. Design, fabricate and install to resist combined positive and negative windloading in accordance with IBC 2009, Section 1609 with a Vmph or 170, qs of 74.0 psf, exposure [B] [C] [D], and importance factor of [1.0] [1.25] [1.5], as applicable per ASCE 7.

SHEET METAL FLASHING AND TRIM 07620-2

SHEET METAL FLASHING AND TRIM 07620-3



1.7 FACTORY TESTS

- A. The manufacturer shall have conducted tests on previously manufactured sheets of the same type and finish as proposed for this project to assure conformance. Sheets shall have passed the following tests:
  - 1. Salt Spray: Withstand a salt spray test for a minimum of 1,000 hours in accordance with ASTM B 117, including the scribe requirement in the test. Immediately upon removal of the panel from the test, the coating shall have received a rating of 10 with no blistering, as determined by ASTM D 1654, Rating Schedule No. 1.
  - 2. Formability: When subjected to a 180 degree bend over a 1/8" diameter mandrel (3/8" diameter mandrel for coatings 4 mils or greater in thickness) in accordance with ASTM D 522, the exterior coating film shall show only slight microchecking of the exterior film, and no loss of adhesion.
  - 3. Accelerated Weathering: Withstand a weathering test of 2,000 hours, minimum, in accordance with ASTM G 152 or ASTM D 2565 without cracking, peeling, blistering, loss of adhesion of the protective coating, or corrosion of the base metal. Protective coating that can be readily removed from the base metal with a penknife blade or similar instrument shall be considered as an indication of the loss of adhesion.
  - 4. Chalking Resistance: After a 2,000 hours weatherometer test, the exterior coating shall not chalk greater than No. 8 rating when measured in accordance with ASTM D 4214.
  - 5. Color Change: After a 2,000 hours weatherometer test, the exterior color change shall not exceed 2 NBS units when measured in accordance with ASTM D 2244.
  - 6. Abrasion Resistance for Color Coating: When subjected to the falling sand test in accordance with ASTM D 968, the coating system shall withstand a minimum of 100 liters of sand before appearance of the base metal.
  - 7. Humidity: When subjected to a humidity cabinet test in accordance with ASTM D 2247 for 1,000 hours, a scored panel shall show no signs of blistering, cracking, creepage, or corrosion.
  - 8. Fire Hazard: Factory-fabricated sheets shall be 30 to 70 at an angle of 60 degrees, when measured in accordance with ASTM D 523.

1.8 DELIVERY, STORAGE AND HANDLING

- A. Section 01600 - Product Requirements: Transport, handle, store, and protect the products.
- B. Protect components during fabrication, shipment, storage, handling, and erection from mechanical abuse, stains, discoloration and corrosion.
- C. Inspect materials upon delivery to the Project Site. Reject and remove physically damaged and marred materials.
- D. Store materials off the ground, providing for drainage; under cover providing for air circulation; protected from wind, foreign material contamination, mechanical damage, cement, lime and other corrosive substances.
- E. Prevent contact with materials which may cause discoloration or staining.

SHEET METAL FLASHING AND TRIM 07620-4

- F. Handle materials to prevent damage to surfaces, edges and ends of sheet metal items. Damaged materials shall be rejected and removed from the Project Site.

1.9 JOB CONDITIONS

- A. Coordinate the work of this Section with interfacing and adjoining work for the proper sequencing of each installation.
- B. Determine that work of other trades will not hamper or conflict with necessary fabrication and storage requirements.
- C. Ensure the best possible weather resistance and durability of the work, and protection of materials and finishes.

1.10 WARRANTY

- A. Section 01780 - Closeout Submittals: Procedures for closeout submittals.
- B. Limited Warranty:
  - 1. Manufacturer's Warranty against checking, crazing, peeling, chalking, fading and adhesion.
  - 2. Warranty Period:
    - a. Manufacturer's twenty (20) years Warranty covering refinishing of the finish coating from the date of Substantial Completion.
    - b. Installer's two (2) years Warranty covering the installation and watertightness from the date of Substantial Completion.

PART 2 PRODUCTS

2.1 SHEET METAL FLASHING AND TRIM MATERIALS

- A. Stainless Steel: AISI Type 302 / 304, #6 satin finish, 24 gauge, soft except where hard temper is required for forming or performance. ASTM 167.
- B. Aluminum Sheet: Prefinished aluminum alloy sheet, .032" thickness except as otherwise indicated, temper appropriate to the end use. ASTM B 209. Exposed aluminum shall have a baked-on, factory-applied color coating of polyvinylidene fluoride (PVF2) or other equivalent fluorocarbon coating per AIA 605.2, applied after the metal substrates have been cleaned and pretreated. Finish coating dry-film thickness shall be 1.0 - 1.3 mils. Color as selected.
- C. Zinc-Coated Steel: Commercial quality with 0.20% copper, ASTM A 653, except ASTM A 527 for lock-forming, G90, hot-dip galvanized, mill phosphatized where indicated for painting, 26 gauge except as otherwise indicated.

2.2 MISCELLANEOUS MATERIALS AND ACCESSORIES

- A. Metal Accessories: Provide sheet metal clips, straps, anchoring devices and similar accessory units as required for installation of the work, matching or compatible with the product material being installed, non-corrosive, size and gauge as required for performance.

SHEET METAL FLASHING AND TRIM 07620-5

- B. Reglets: Metal or plastic units of the type and profile indicated, compatible with the flashings indicated, non-corrosive.
- C. Fasteners: Same metal as the flashing / sheet metal or stainless steel, as recommended by the sheet manufacturer. Match finish or exposed heads with the material being fastened.
- D. Solder: For use with steel; provide 50 - 50 tin / lead solder with rosin flux. ASTM B 32.
- E. Adhesives: Type recommended by the flashing sheet manufacturer for waterproof / weather-resistant seaming and adhesive application of flashing sheet and substrate.
- F. Elastic Flashing Filler Rods: Closed-cell polyethylene or other soft closed-cell material recommended by the elastic flashing manufacturer as filler under flashing loops to ensure movement with minimum stress on the flashing sheet.
- G. Mastic Sealant: Polyisobutylene; non-hardening, non-skimming, non-drying, non-migrating sealant.
- H. Elastomeric Sealant: Generic type as recommended by the manufacturer of the metal or fabricator of the components being sealed.
- I. Gutter and Conductor-Head Guards: .032" aluminum or 20 gauge bronze or non-magnetic stainless steel mesh, or fabricated units, with salvaged edges and non-corrosive fasteners. Select materials for compatibility with the gutters and downspouts.
- J. Unit Plumbing Vent: Integral stack pipe flashing with elastomeric base, for flat or pitched roof applications, size as required by the pipe size.
- K. Protective Backing Paint: Bituminous.

### 2.3 FABRICATED UNITS

- A. General Material Fabrication: Shop fabricate work to the greatest extent possible. Comply with the details shown, and with the applicable requirements of SMACNA Architectural Sheet Metal Manual®, and other recognized industry practices. Fabricate for waterproof and weather-resistant performance, with expansion provisions for running work; sufficient to permanently prevent leakage, damage and deterioration of the work. Form work to fit the substrates. Comply with the material manufacturer's instructions and recommendations. Form exposed sheet metal work without excessive oil-canning, buckling and tool marks, true to line and levels as indicated, with exposed edges folded back to form hems.
- B. Flashings, Counter Flashings, Copings, Expansion Joints, Scuppers: Fabricate from 20 oz. / sq. ft. copper sheet unless otherwise indicated.
- C. Aluminum Gutter: .075" conforming to ASTM B 221 with baked-on, factory-applied color coating of polyvinylidene fluoride (PVF2) or other equivalent fluorocarbon coating per AIAA 605.2, applied after the metal substrates have been cleaned and pretreated. Finish coating dry-film thickness shall be 1.0 - 1.3 mils. Color as selected.
- D. Downspouts: Fabricate from .032" aluminum; form in continuous lengths.
- E. Seams: Fabricate non-moving seams in sheet metal as flat-lock type. For metal other than aluminum, tin the edges to be seamed, form seams, and solder. Form aluminum seams with epoxy seam sealer; rivet joints for additional strength where required.
- F. Expansion Provisions: Where lapped or bayonet-type expansion provisions cannot be used, or would not be sufficiently water / weatherproof, form expansion joints of intermeshing

SHEET METAL FLASHING AND TRIM 07620-6

- G. Hooked flanges, not less than 1" deep, filled with mastic sealant, concealed within the joints.
- H. Sealant Joints: Where movable, non-expansion type joints are indicated or required for proper performance of the work, form the metal to provide for proper installation of elastomeric sealant in accordance with SMACNA standards.
- I. Separations: Provide for the separation of metal from non-compatible metal or corrosive substrates by coating concealed surfaces at locations of contact, with a bituminous coating or other permanent separation as recommended by the manufacturer / fabricator.

### PART 3 EXECUTION

#### 3.1 EXAMINATION

- A. Section 01700 - Execution Requirements: Verification of existing conditions before starting the work.
- B. Verification of Conditions: Verify that field measurements, surfaces, substrates and conditions are as required, and ready to receive the work.
  1. Verify that roof openings, curbs, pipes, sleeves, ducts, and vents through the roof are solidly set, reglets in place, and nailing strips located.
  2. Verify that roofing termination and base flashings are in place, sealed, and secure.
- C. Report, in writing, prevailing conditions that will adversely affect satisfactory execution of the work of this Section. Do not proceed with the work until the unsatisfactory conditions have been corrected.

#### 3.2 PREPARATION

- A. Install starter and edge strips, and cleats before starting the installation.
- B. Install concrete inserts, reglets and similar anchoring devices to be built into substrates and walls prior to the time the flashing installation is to begin.
- C. Install surface-mounted reglets true to lines and levels. Apply sealant along the top of reglets.

#### 3.3 INSTALLATION

- A. Comply with the manufacturer's installation instructions and recommendations, and with SMACNA Architectural Sheet Metal Manual®.
- B. Fit flashings, gutters, and downspouts tight in place, make corners square, surfaces true and straight in planes, and lines accurate to the profiles.
- C. Anchor units securely in place by the methods indicated, providing for thermal expansion of metal units.
- D. Secure work in place using concealed fasteners where possible.
- E. Set units true to line and level as indicated.
- F. Install work with laps, joints and seams to be permanently watertight and weatherproof.

SHEET METAL FLASHING AND TRIM 07620-7

CENTRAL POLICE PRECINCT

- G. Install reglets to receive counter flashings in a manner and by the methods indicated. Where shown in concrete, furnish reglets to the concrete trade for installation as the work of Sections of Division 3. Where shown in masonry, furnish reglets to the masonry trade for installation as the work of Division 4 Sections.
- H. Install counterflashings in reglets, either by shape-in seal arrangement, or by wedging in place and filling the reglet with mastic or elastomeric sealant, as indicated, depending on the degree of sealant exposure.
- I. Expansion and Contraction: Provide expansion and contraction joints at not more than 30 foot intervals. Space joints evenly and as approved.
- J. Install elastic flashings in accordance with the manufacturer's recommendations. Where required, provide for movement at joints by forming loops or bellows the full width of the flashing. Locate cover or filter strips at joints to facilitate complete drainage of water from the flashings. Seam adjacent flashing sheets with adhesive, seal and anchor edges in accordance with the manufacturer's recommendations.
- K. Install continuous gutter guards on gutters. Provide hinged units to swing open for cleaning the gutters. Install beehive type strainer-guards at conductor heads, removable for cleaning downsloups.

#### 3.4 ISOLATION REQUIREMENTS

- A. Where stainless steel or aluminum is to be installed directly on cementitious or wood substrates, install a course of paper slip sheet and a course of polyethylene underlayment.
- B. Concrete Contact: Coat the underside of sheet metal over horizontal concrete surfaces, with asphaltum cement.
- C. Dissimilar Metals: Insulate the juncture between dissimilar metals with a heavy coat of insulating film. Where drainage from a dissimilar metal passes over aluminum, paint the dissimilar metal with a non-lead pigmented paint.
- D. Wood Contact: Isolate sheet metal from cedar, redwood, oak and acid-treated lumber by means of an unbroken 6 mil polyethylene construction sheet, or a heavy coating of metal protective paint.

#### 3.5 PROTECTION

- A. The Installer shall advise the Contractor of required procedures for surveillance and protection of the flashings and sheet metal work during the remainder of the construction, to ensure that the work will be without damage or deterioration, other than natural weathering, at the time of Substantial Completion.

#### 3.6 ADJUSTING

- A. Section 01700 - Execution Requirements: Adjusting the installed work.
- B. Touch-up exposed fasteners using paint furnished by the metal manufacturer, and matching the exposed metal surface finish.
- C. Touch-up minor abrasions and scratches in surface finishes.
- D. Scratches, abrasions and minor surface defects to the finish may be repaired in accordance with the manufacturer's printed instructions. Replace items which cannot be repaired.

SHEET METAL FLASHING AND TRIM 07620-8

SHEET METAL FLASHING AND TRIM

07620-9

#### 3.7 FIELD QUALITY CONTROL

- A. Section 01450 - Quality Control: Field inspection.
- B. Inspection the installations for proper support, alignment, watertight and weatherproof.

#### 3.8 CLEANING

- A. Section 01700 - Execution Requirements: Cleaning the installed work.
- B. Remove excess sealants as approved by the metal manufacturer.
- C. Clean exposed metal surfaces to remove all substances which might cause corrosion or metal or deterioration of finishes.
- D. Leave the entire installation in a clean condition on the date of Substantial Completion.

END OF SECTION

SECTION 07840

FIRESTOPPING

PART 1 GENERAL

1.1 SUMMARY

- A. Section Includes
  - 1. Firestop sealant and safing insulation for the following locations:
    - a. All pipes, ductwork, conduit and other penetrations through a fire-rated walls, floor assemblies and roof assemblies.
    - b. Head of wall firestopping at full-height, fire-rated partitions.
    - c. Closure of penetrations for acoustic purposes.
- B. Related Documents: The Contract Documents, as defined in Section 01010 - Summary of Work, apply to the work of this Section. Additional requirements and information necessary to complete the work of this Section may be found in other Documents.

C. Related Sections:

- 1. Section 03300 - Cast-In-Place Concrete: Substrate for firestopping.
- 2. Section 04230 - Reinforced Unit Masonry: Substrate for firestopping.
- 3. Section 07210 - Building Insulation: Wall and roof insulation.
- 4. Section 07900 - Joint Sealers: Non-firestopping joint sealers.
- 5. Section 09250 - Gypsum Board: Substrate for firestopping.

1.2 DESCRIPTION OF WORK

- A. The extent of each type of firestopping is indicated on the Drawings and as specified herein, and includes providing and installing fire safing at penetrations thru fire-rated assemblies, roofs and head of wall firestopping at full-height, fire-rated partitions.

1.3 REFERENCES

- A. The publications listed below form a part of this Specification to the extent referenced. Publications are referred to in the text by basic designation only.
- B. American Society for Testing and Materials (ASTM):
  - 1. ASTM C 612 - Specification for Mineral Fiber Block and Board Thermal Insulation.
  - 2. ASTM E 84 - Test Method for Surface Burning Characteristics of Building Materials.
  - 3. ASTM E 119 - Test Methods for Fire Tests of Building Construction and Materials.
  - 4. ASTM E 136 - Test Method for Behavior of Materials in a Vertical Tube Furnace at

FIRESTOPPING

07840-1

CENTRAL POLICE PRECINCT

750E C.

- 5. ASTM E 814 - Test Method for Fire Tests of Through-Penetration Fire Stops.
- 6. ASTM E 2307 - Test Method for Determining Fire Resistance of Perimeter Fire Barrier Systems Using Intermediate-Scale, Multi-story Test Apparatus.

C. Underwriters Laboratories, Inc. (UL):

- 1. UL 1479 - Tests of Through-Penetration Firestops.
- 2. UL 2079 - Tests for Fire Resistance of Building Joint Systems.

1.4 DEFINITIONS

- A. Firestopping: Sealing materials and assemblies installed in spaces between building materials to prevent movement of smoke, heat, gasses, and fire through wall openings.

1.5 SYSTEM DESCRIPTION

- A. Firestopping Materials: ASTM E 119, ASTM E 814, UL 1479 to achieve the fire rating indicated on the Drawings.

1.6 SUBMITTALS

- A. Section 01330 - Submittal Procedures: Procedures of submittals.
  - 1. Product Data: Manufacturer's specifications for each joint firestop sealer, grout and safing insulation product required, including instructions for joint preparation and joint sealer application for insulation installation, product characteristics, performance, and limitations.
  - 2. Assurance / Control Submittals:
    - a. Manufacturer's certificate that the products meet or exceed the specified requirements and are suitable for the intended use.
    - b. Certified Test Reports showing compliance with the specified performance values, including r-values (aged values for plastic insulations), densities, compression strengths, fire performance characteristics, perm rating, water absorption ratings at similar properties.
    - c. Product Test Reports for each type of joint firestop sealer evidencing compliance with requirements.
    - d. Documentation of experience indicating compliance with the specified qualifications requirements.
- B. Section 01780 - Closeout Submittals: Procedures for closeout submittals.
  - 1. Warranty: Provide a written special Warranty with forms completed in the name of the Owner and registered with the manufacturer.

1.7 QUALITY ASSURANCE

- A. Qualifications:

FIRESTOPPING

07840-2

1. Manufacturer: Company specializing in manufacturing the products specified with a minimum of five (5) years documented experience.
  2. Installer: Company that has successfully completed at least three (3) sealer applications similar in type and size within the last three (3) years, and is approved by the manufacturer for this type of installation.
- B. Pre-Installation Meeting: Prior to beginning the installation of materials, meet at the Project Site with the Owner's representative, Contractor, Installer and subcontractors of the affected trades. Review conditions, methods and procedures necessary for proper installation of the work, including inspections of areas of work, requirements of the Specifications, and the manufacturer's literature; review submittals and the installation schedule.
- 1.8 DELIVERY, STORAGE AND HANDLING
- A. Section 01600 - Product Requirements: Transport, handle, store and protect the products.
  - B. Deliver products to the Project Site in the manufacturer's original, unopened containers or packages with labels intact, identifying the manufacturer, product name and designation, expiration date for use, pot life, curing time, and mixing instructions for multi-component materials.
  - C. Store and handle materials in compliance with the manufacturer's recommendations to prevent deterioration and damage due to moisture, high or low temperatures, contaminants or other causes.
  - D. Protect insulations from physical damage from becoming wet or soiled.
- 1.9 JOB CONDITIONS
- A. Environmental Requirements:
    1. Maintain the manufacturer's recommended minimum temperature before, during, and for 3 days after installation of the materials.
    2. Keep products away from heat, open flame, sparks, and other sources of ignition until curing is complete.
    3. Install only when adequate ventilation is provided.
    4. Do not proceed with installation of firestop joint sealers when ambient and substrate conditions are outside the limits permitted by the manufacturer when substrates are wet due to rain, condensation, or other causes.
    5. Do not proceed with installation of firestop joint sealers until contaminants capable of interfering with adhesion has been removed from the joint substrates.

1.10 WARRANTY

- A. Section 01780 - Closeout Submittals: Procedures for closeout submittals.
- B. Special Warranty:
  1. Contractor to warrant that the firestopping systems will provide a permanent installation.

FIRESTOPPING 07840-3

2. Warranty Period: Life of the building.

PART 2 PRODUCTS

2.1 FIRE-RESISTANT JOINT SEALERS

- A. Firestop materials shall have been tested with and shall be in compliance with the minimum requirements of ASTM E 814, UL 1479, and UL 2079, as applicable. Products used shall be as listed below, as suitable for the intended application and as required to produce the fire rating shown on the Drawings and to conform to the Firestopping Schedule at the end of this Section.
  1. Nelson Firestop Products.
  2. Hilti, Inc.
  3. The RectorSeal Corp.
  4. Specified Technologies, Inc. (STI).
  5. 3M Fire Protection Products.
  6. Tremco Firestop Systems.
- B. General: Provide manufacturer's standard fire-stopping sealants, with the necessary accessory materials, having fire resistance ratings indicated, as established by testing identical assemblies per ASTM E 814 by Underwriters Laboratories Inc. or other testing and inspecting agency acceptable to the authorities having jurisdiction.

2.2 MANUFACTURERS

- A. Subject to compliance with the Project requirements, manufacturers offering firestopping materials which may be incorporated into the work include the following:
  1. Nelson Firestop Products.
  2. Hilti, Inc.
  3. The RectorSeal Corp.
  4. Specified Technologies, Inc. (STI).
  5. 3M Fire Protection Products.
  6. Tremco Firestop Systems.
- B. Section 01600 - Product Requirements: Product Options: Substitutions not permitted.

2.3 MATERIALS

- A. Intumescent Latex or Acrylic Sealant: Single-component, intumescent, latex or acrylic formulation.
  1. LBS by Nelson Firestop.
  2. FS ONE or CP 606 by Hilti.
  3. Metacaulk 950 or 1000 by RectorSeal.
  4. SpecSeal SSS100 by STI.
  5. CP 25WB+ by 3M.
  6. TREMstop WBM by Tremco.
- B. Intumescent Solvent-Release-Curing Sealant: Single component, intumescent, synthetic-polymer based, non-sag grade.

FIRESTOPPING 07840-4

- 1. CP 25 N/S by 3M.
  - 2. TREMstop WBM by Tremco.
- C. Intumescent Wrap / Strip: Single-component, elastomeric sheet with aluminum foil on one face.
- 1. WRS by Nelson Firestop.
  - 2. CP 645 Wrap Strip by Hilti.
  - 3. Metacaulk Wrap Strip by RectorSeal.
  - 4. SpecSeal SSWRED Wrapstrip by STI.
  - 5. FS-195+ Wrap / Strip by 3M.
  - 6. TREMstop WS by Tremco.
- D. Intumescent Putty: Single-component, non-hardening, dielectric.
- 1. FSP by Nelson Firestop.
  - 2. CP 618 Putty Stick or CP 617/ 617L Putty Pad by Hilti.
  - 3. CP 645 Wrap Strip by Hilti.
  - 4. CP 658 Firestop Plug by Hilti.
  - 5. Metacaulk Fire Rated Putty by RectorSeal.
  - 6. SpecSeal Putty by STI.
  - 7. Moldable Putty+ by 3M.
- E. Silicone Sealant: Single-component, moisture-curing, silicone-based elastomeric, non-sag grade.
- 1. CLK N/S by Nelson Firestop.
  - 2. CP 601S by Hilti.
  - 3. Metacaulk 835 by RectorSeal.
  - 4. SpecSeal PEN 300 by STI.
  - 5. 2000+ Silicone by 3M.
  - 6. FRYE SIL by Tremco.
- F. Silicone or Polyurethane Foam: Two-component, liquid elastomer that, when mixed, expands and cures in place to produce a flexible, non-shrinking foam.
- 1. SpecSeal PEN 200 by STI.
  - 2. 2001 Silicone RTV Foam by 3M.
- G. Intumescent Collar: Factory-fabricated, intumescent collar.
- 1. PCS by Nelson Firestop.
  - 2. CP 642 or CP 643 by Hilti.
  - 3. Metacaulk Pipe Collar by RectorSeal.
  - 4. SpecSeal SSC Collars by STI.
  - 5. Plastic Pipe Device by 3M.
  - 6. TREMstop D by Tremco.
- H. Intumescent Composite Sheet, Pillows and Mortar or Blocks: Products used to firestop large openings.
- 1. CPS by Nelson Firestop.
  - 2. FS 657 Fireblocks by Hilti.
  - 3. CP 637 Firestop Mortar by Hilti.
  - 4. CP 675T Firestop Board by Hilti.
  - 5. SpecSeal SSB Pillows and SpecSeal SSM Firestop Compound by STI.
  - 6. CS-195+ Composite Sheet by 3M.
  - 7. TREMstop PS by Tremco.
- I. Sprayable Fire-Rated Mastic: Products used to firestop construction joints.
- 1. CP 672 Speed Spray by Hilti.
  - 2. SpecSeal Elastomeric Spray by STI.
  - 3. FireDam Spray by 3M.
- J. Packing Material: Manufacturer's standard mastic, putty, ceramic fiber blanket, or mineral wool to be used as fill or backing material for firestopping.
- 1. FSB or Mineral Wool by Nelson Firestop.
  - 2. Mineral Wool by Hilti.
  - 3. Fire Safing or Backer Rod by RectorSeal.
  - 4. Mineral Wool by STI.
  - 5. FireMaster Mastic, FireMaster Putty, or FireMaster Bulk by 3M.
  - 6. Cerablanket by Tremco, Canada.
  - 7. CP 777 Speed Plugs by Hilti (preformed mineral wool designed for top of wall

FIRESTOPPING

07840-5

FIRESTOPPING

07840-6

K. Safing and Smoke Stop: Thermafiber Safing Insulation, 4" thick, 4 pcf high melt point, mineral wool, uniaxial and Thermafiber Smoke Stop System with Smoke Seal compound as required for the use and location.

1. Remove all foreign materials from joint substrates which could interfere with adhesion of the joint sealer, including dust, paint, except for permanent, protective coatings tested and approved for sealant adhesion and compatibility by the sealant manufacturer; old joint sealers; oil; grease; waterproofing; water repellents; water, and surface dirt.

L. Accessory Materials for Fire-Stopping Sealants: Provide forming, joint fillers, packing and other accessory materials required for installation of fire-stopping sealants as applicable to the installation conditions indicated.

B. Clean concrete, masonry, unglazed surfaces of ceramic tile and similar porous joint substrate surfaces by brushing, grinding, blast cleaning, mechanical abrading, or a combination of these methods to produce a clean, sound substrate capable of developing optimum bond with the joint sealer.

2.4 FIRE INSULATING MATERIALS

A. General: Provide insulating materials which comply with the requirements indicated for materials, compliance with the referenced standards, and other characteristics.

B. Semi-Refractory Fiber Board Safing Insulation: Semi-rigid boards designed for use as a firestop at openings between slab and exterior wall panels at the top of rated walls as shown; produced by combining semi-refractory mineral fiber manufactured from slag with thermosetting resin binders to comply with ASTM C 612, passing ASTM E 136 for combustion characteristics; R-value of 4.0 at 750° F, melting point exceeding 2000 degrees F. Supports to be 26 gage galvanized steel.

1. Manufacturer's of Semi-Refractory Fiber Insulation:

- a. Johns Manville Corp.
- b. 3M.
- c. United States Gypsum Co.

C. Section 01600 - Product Requirements: Product Options: Substitutions permitted.

PART 3 EXECUTION

3.1 EXAMINATION

A. Section 01700 - Execution Requirements: Verification of existing conditions before starting the work.

B. Verification of Conditions: Verify that field measurements, surfaces, and conditions are as required, and ready to receive the work.

C. With the Installer present, examine surfaces to receive joint sealers for compliance with requirements for joint configuration, installation tolerances and other conditions affecting joint sealer performance.

D. Report, in writing, prevailing conditions that will adversely affect satisfactory execution of the work of this Section. Do not proceed with the work until the unsatisfactory conditions have been corrected.

3.2 PREPARATION

A. Clean joints immediately before installing joint sealers to comply with recommendations of the joint sealer manufacturer and the following requirements:

- C. Remove loose particles remaining from the cleaning operations by vacuuming or blowing out the joints with oil-free compressed air.
- D. Remove laitance and form release agents from concrete.
- E. Prime joint substrates where recommended by the joint sealer manufacturer based on preconstruction joint sealer-substrate tests or prior experience. Apply primer to comply with joint sealer manufacturer's recommendations. Confine primers to areas of the joint sealer bond. Do not allow spillage or migration onto adjoining surfaces.
- F. Place hangers or damming devices in penetrations to hold firestopping materials in place, where necessary.

3.3 INSTALLATION

A. General:

- 1. Comply with the manufacturer's printed installation instructions applicable to the product and application required, except where more stringent requirements apply.
- 2. Comply with the manufacturer's recommendations for protection during installation.

B. Install firestopping at penetrations of fire-rated walls by sleeves, piping, ductwork, conduit and other items in accordance with the manufacturer's published instructions. Follow the manufacturer's chart for the appropriate material for use to achieve the required fire rating in the various locations.

C. Install sealant, including forming, packing, and other accessory materials to fill openings around mechanical and electrical services penetrating walls and floors to provide fire-stops with the fire-resistance ratings indicated for wall and floor assemblies in which the penetrations occur. Comply with the installation requirements established by testing and inspecting agency.

D. At full-height fire-rated walls / partitions: Protect all fire safing insulation by installing a 22 gage galvanized sheet metal closure at the top and bottom, for protection of the fire safing insulation. Tool exposed surfaces of mortar or sealants. Where plastic pipes penetrate floors, provide a galvanized steel sleeve around the pipes and fire stop sealant within the sleeve.

E. At openings between exterior walls and floors / roofs, install fire safing insulation per the manufacturer's instructions.

3.4 FIELD QUALITY CONTROL

FIRESTOPPING

07840-7

FIRESTOPPING

07840-8

Gypsum Board Partition to	N/A	N/A	N/A	N/A	WWS0004	N/A
---------------------------	-----	-----	-----	-----	---------	-----

END OF SECTION

- A. Section 01450 - Quality Control: Field inspection.
- B. The Owner's representative will inspect firestopping installations. Do not cover installations by other construction until the Owner's representative has completed an inspection.

3.5 CLEANING

- A. Section 01700 - Execution Requirements: Cleaning the installed work.
- B. Clean excessive fill material and sealants adjacent to openings and joints as the work progresses by methods and with cleaning materials approved by the manufacturers of the firestopping products and of products in which openings and joints occur.

3.6 PROTECTION

- A. Protect joint sealers and insulation from contact with contaminating substances and from damage resulting from construction operations or other causes so they are without damage at the time of Substantial Completion.
- B. If damage or deterioration does occur, cut out and remove the damaged or deteriorated joint sealers and make repairs indistinguishable from the original installations.

3.9 FIRESTOPPING SCHEDULE

- A. Provide firestopping complying with the UL assemblies specified below:

Penetration	Assembly	Nelson	Hilti	RectorSeal	STI	3M	Tremco
Metal Pipe	CMU Wall 8" Thick or Less	CAJ1224	CAJ1149	CAJ1114	CAJ1079	CAJ1001	CAJ1179
		or CAJ1203	or CAJ1155	or CAJ1115	or CAJ1217	or CAJ1009	or CAJ1187
Non-Metallic Pipe	Gypsum Board Partition	WL1083	WL1054	WL1026	WL1049	WL1003	WL1020
		or CAJ2086	or CAJ2110	or CAJ2021	or CAJ2064	or CAJ2005	or CAJ2082
Cable Tray	CMU Wall 8" Thick or Less	WL2071	WL2088	WL2045	WL2053	WL2002	WL2063
		or CAJ8049	or CAJ4035	or CAJ8043	or CAJ4020	or CAJ4003	or CAJ4007
Insulated Metal Pipe	Gypsum Board Partition	WL4003	WL4011	N/A	WL4005	WL4004	WL3043
		or CAJ5008	or CAJ5090	or WJ5016	or CAJ5021	or CAJ5001	or CAJ5052
Constructio	CMU Wall to Gypsum Board Partition to Metal	WL5038	WL5028	WL5037	WL5044	WL5007	WL5039
		or N/A	or HWD0098	or TRC/PIV12	or N/A	or HWD0013	or N/A
Construction Gaps - Wall to Wall	CMU Wall to CMU Wall	N/A	HWD0042	HWD0014	N/A	HWS0003	WHPV60.01
		or N/A	or WWD019	or N/A	or N/A	or WWS1001	or N/A

FIRESTOPPING

07840-9

FIRESTOPPING

07840-10



SECTION 07900  
JOINT SEALERS

PART 1 GENERAL  
1.1 SUMMARY

- A. Section Includes:
1. Sealants.
  2. Backing.
  3. Substrate preparation.
- B. Related Documents: The Contract Documents, as defined in Section 01010 - Summary of Work, apply to the work of this Section. Additional requirements and information necessary to complete the work of this Section may be found in other Documents.
- C. Related Sections:
1. Section 03300 - Cast-In-Place Concrete: Sealant used in conjunction with concrete work.
  2. Section 04230 - Reinforced Unit Masonry: Sealant used in conjunction with masonry work.
  3. Section 05800 - Expansion Control: Sealant for waterproofing expansion joints.
  4. Section 06400 - Architectural Woodwork: Sealant to prevent vermin and moisture penetration into concealed spaces.
  5. Section 06650 - Solid Polymer Fabrications: Sealant to prevent vermin and moisture penetration into concealed spaces.
  6. Section 07110 - Waterproofing: Sealant for waterproofing concrete work.
  7. Section 07120 - Fluid-Applied Urethane Roofing: Sealant for waterproofing roofing applications.
  8. Section 07125 - Fluid-Applied Elastomeric Roofing (Acrylic): Sealant for waterproofing roofing applications.
  9. Section 07190 - Water Repellents (Sealer): Sealant for waterproofing concrete walks and floors.
  10. Section 07250 - Fireproofing: Sealants used in fireproofing.
  11. Section 07410 - Preformed Metal Roofing: Sealant for waterproofing metal roofing systems.
  12. Section 07415 - Exterior Wall Panel System: Sealant for waterproofing metal wall systems.

JOINT SEALERS

07900-1

13. Section 07620 - Sheet Metal Flashing and Trim: Sealant for weatherproofing metal roofing and flashings.
14. Section 07724 - Roof Hatch: Sealant for waterproofing roof hatch installations.
15. Section 07840 - Firestopping: Sealants for use in fire-rated assemblies.
16. Section 08100 - Hollow Metal Doors and Frames: Sealants for weatherproofing door and window frame perimeters and thresholds.
17. Section 08310 - Access Doors and Panels: Sealant to close joint where metal edge trim meets adjacent surfaces.
18. Section 08330 - Overhead Coiling Doors: Sealants for weatherproofing door frame perimeters and thresholds.
19. Section 08400 - Entrances, Storefronts and Windows: Sealants for weatherproofing frame perimeters and thresholds.
20. Section 08800 - Glass and Glazing: Sealants and compound for glass and glazing installations.
21. Section 09250 - Gypsum Board: Sealant for back of control joints and to close joint where edge trim meets adjacent surfaces; acoustical sealants.
22. Section 09300 - Tile: Sealants for tile and threshold installations.
23. Section 09510 - Gypsum Board: Sealant to close joint where edge trim meets vertical surfaces.
24. Section 10200 - Louvers and Vents: Sealants to close joint where metal edge trim meets vertical surfaces.
25. Section 10500 - Metal Lockers: Sealant to close joint where metal edge trim meets vertical surfaces.
26. Section 10810 - Toilet Accessories: Sealants to prevent moisture penetration into concealed areas.
27. Section 12305 - Science Casework and Laboratory Equipment: Sealant to prevent vermin and moisture penetration into concealed spaces.
28. Section 14240 - Hydraulic Elevators: Sealant to prevent moisture penetration into concealed spaces.
29. Section 14245 - Tracton Elevators: Sealant to prevent moisture penetration into concealed spaces.
30. Section 14560 - Chutes: Sealant to prevent moisture penetration into concealed spaces.

1.2 DESCRIPTION OF WORK

- A. The extent of joint sealers work is indicated on the Drawings and as specified herein, and includes providing and installing sealants, complete. The principal item of work is the

JOINT SEALERS

07900-2

sealing of openings and joints indicated, specified, and as required to make the entire building weatherproof and watertight.

B. This Section contains general specifications for sealants throughout the Project. The specific use for joint sealants is indicated in the Sealant Schedule at the end of this Section.

### 1.3 REFERENCES

- A. The publications listed below form a part of this Specification to the extent referenced. Publications are referred to in the text by basic designation only.
- B. American Society for Testing and Materials (ASTM):
1. ASTM C 717 - Terminology of Building Seals and Sealants.
  2. ASTM C 834 - Specification for Latex Sealants.
  3. ASTM C 920 - Specification for Elastomeric Joint Sealants.
  4. ASTM C 1193 - Guide for Use of Joint Sealants.
  5. ASTM C 1299 - Guide for Use in Selection of Liquid-Applied Sealants.
  6. ASTM D 1056 - Specification for Flexible Cellular Materials - Sponge or Expanded Rubber.

### 1.4 SUBMITTALS

- A. Section 01330 - Submittals: Procedures for submittals.
1. Product Data: Manufacturer's specifications, recommendations, handling, installation and curing instructions for each type of sealant and associated miscellaneous material required. Include chemical characteristics, performance criteria, substrate preparation, limitations, color availability and VOC content.
  2. Samples: 2" long of each color required for each type of sealant exposed to view.
  3. Assurance / Control Submittals:
    - a. Manufacturer's certificate that the products meet or exceed the specified requirements.
    - b. Manufacturer's Material Safety Data Sheets (MSDS).
    - c. Manufacturer's certification that the products supplied comply with applicable federal and local regulations controlling the use of volatile organic compounds (VOC).
    - d. Manufacturer's instructions indicating procedures and conditions requiring special attention, and cautionary procedures required during application.
    - e. Documentation of experience indicating compliance with the specified qualifications requirements.
- B. Section 01780 - Closeout Submittals: Procedures for closeout submittals.

JOINT SEALERS 07900-3

1. Warranty: Provide a written special Warranty with forms completed in the name of the Owner and registered with the manufacturer.

### 1.5 QUALITY ASSURANCE

- A. Qualifications:
1. Manufacturer: Company specializing in manufacturing the products specified with a minimum of five (5) years documented experience.
  2. Installer: Company experienced in performing the work of this Section with a minimum of five (5) years documented experience.

### 1.6 DELIVERY, STORAGE AND HANDLING

- A. Section 01600 - Product Requirements: Transport, handle, store and protect the products.
- B. Deliver products to the Project Site in the manufacturer's original, new, unopened packages or containers, dry and undamaged with seals and labels intact, identifying the product and manufacturer, product designation, date of manufacture, lot number, shelf life, curing time, and mixing instructions, if applicable.
- C. Handle and store materials to prevent deterioration and damage due to moisture, temperature changes, contaminants and other causes.
- D. Store materials not in actual use out of the weather until ready for use. Maintain packages and containers in a clean condition, free of foreign materials and residue.
- E. Store materials in a ventilated area, and in compliance with the manufacturer's printed instructions.
- F. Keep storage areas neat and orderly.
- G. Protect against fire hazards and spontaneous combustion.
- H. Take all necessary precautions to ensure that workmen and the work areas are adequately protected from health hazards resulting from handling, mixing and installation of the materials.

### 1.7 JOB CONDITIONS

- A. Environmental Requirements: Install sealants only during the manufacturer's recommended temperature ranges and weather conditions for proper application and cure. Consult the manufacturer if a sealant cannot be applied under the recommended conditions.

### 1.8 WARRANTY

- A. Section 01780 - Closeout Submittals: Procedures for closeout submittals.
- B. Special Warranty:
1. Submit a joint and severable written Warranty signed by the sealant manufacturer and the installer certifying that the products and installation is free of defective materials and workmanship and agreeing to repair or replace sealants and accessories which fail because of loss of cohesion or adhesion, which do not

JOINT SEALERS 07900-4

cure properly or are improperly installed.

2. Warranty Period: Three (3) years from the date of Substantial Completion.

## PART 2 PRODUCTS

### 2.1 MATERIALS

A. General Performance Requirements: Select materials for compatibility with the joint surfaces to be encountered and other indicated exposures, and except as otherwise indicated, select modulus of elasticity and hardness or grade recommended by the manufacturer for each application indicated.

B. Where exposed to foot traffic, select materials of sufficient strength and hardness to withstand stiletto heel traffic without damage or deterioration of the sealant system.

C. Subject to compliance with the Project requirements, manufacturers offering products which may be incorporated into the work include the following:

#### 1. Urethanes:

- a. Two-Part Urethane: Self-Leveling, ASTM C 920, Type M, Grade P, Class 25.
  - 1) Chem-Calk 550 by Bostik.
  - 2) Vulkem 245 by Tremco (formerly Mameco International, Inc.)
  - 3) Vulkem 255 FM by Tremco.
  - 4) Urexpan NR-200 by Pecora Corporation.
  - 5) Sikaflex 2c SL by Sika Group.
- b. Two-Part Urethane: Non-Sag, ASTM C 920, Type M, Grade NS, Class 25.
  - 1) Chem-Calk 500 by Bostik.
  - 2) Sonolastic NP 2 by Sonneborn Building Products
  - 3) Vulkem 227 by Tremco.
  - 4) Dynatrol II by Pecora.
  - 5) Sikaflex-2c NS EX Mix by Sika.

- c. One-Part Urethane: Self-Leveling, ASTM C 920, Type S, Grade P, Class 25.
  - 1) Vulkem 45 by Tremco.
  - 2) Sonolastic SL 1 by Sonneborn.
  - 3) Urexpan NR-201 by Pecora.

JOINT SEALERS

07900-5

- d. One-Part Urethane: Non-Sag, ASTM C 920, Type S, Grade NS, Class 25.
  - 1) Chem-Calk 900 by Bostik.
  - 2) Sonolastic NP 1 by Sonneborn.
  - 3) Vulkem 116 by Tremco.

#### 2. Silicones:

a. One-Part Silicones: ASTM C 920, Type S, Grade NS, Class 25. Vertical Surfaces Only.

- 1) 795 Silicone Building Sealant Structural Glazing, Glazing and Weatherproofing Sealant by Dow Corning. (colors only)
- 2) Construction 1200 Sealant by General Electric Company.
- 3) 999-A Silicone Building and Glazing Sealant by Dow Corning.
- 4) 864 Architectural Silicone by Pecora.

b. One-Part Silicones: ASTM C 920, Type S, Grade NS, Class 25.

- 1) 786 Mildew Resistant Silicone Sealant by Dow.
- 2) Sanitary 1700 Silicone Sealant by General Electric.
- 3) 898 Sanitary Mildew Resistant Silicone Sealant by Pecora.

#### 3. Acrylics, Latex:

a. One-Part Acrylic Latex, Non-Sag, ASTM C 834.

- 1) Chem-Calk 600 by Bostik.
- 2) LC-130 Liquid Nails Caulk Window and Door Acrylic Latex by Macco Adhesives.
- 3) AC-20 Acrylic Latex Caulking, Non-Sag by Pecora.
- 4) Sonolac Acrylic Latex Caulk by Sonneborn.

#### 4. Acoustical Sealants:

a. AC-20 FTR Fire and Temperature Rated Acoustical and Insulation Sealant by Pecora.

b. Sheetrock Acoustical Sealant by United States Gypsum Co.

#### 5. Butyls:

a. One-Part Butyl, Non-Sag, FS TT-S-1657.

- 1) Chem-Calk 300 Butyl Rubber Caulk by Bostik.

JOINT SEALERS

07900-6

- 2) BC-158 Butyl Rubber Caulk by Pecora.
6. Performed Compressible & Non-Compressible Fillers:
  - a. Backer Rod - Closed cell polyethylene foam:
    - 1) Chem-Rod / Closed by Bostik.
    - 2) Expand-O-Foam by Williams Products.
    - 3) HBR Backer Rod by Nomaco, Inc.
    - 4) Sonofoam Closed-Cell Backer Rod by Sonneborn.
  - b. Backer Rod - Open cell polyurethane foam:
    - 1) Denver Foam by Backer Rod Manufacturing.
    - 2) Foam Pack II by Nomaco.
  - c. Neoprene compression seals:
    - 1) WA and WE Series by Watson Bowman Acme.
  - d. Butyl Rod: Kirkhill Rubber Co.
7. Paving Sealants:
  - a. Two-Part Urethane: Self-Leveling, ASTM C 920, Type M, Grade P, Class 25.
    - 1). Vulkem 202 by Tremco, (Jet Fuel Resistant) (FS SS-S-200E, Type H only).
    - 2). NR-300 Urexpam by Pecora (FS SS-S-200E).
  - b. One-Part Urethane: Self-Leveling, ASTM C 920, Type S, Grade P, Class 25.
    - 1). SONOMETRIC 1 Sealant by Sonneborn (FS SS-S-200E).
    - 2). Vulkem 45 by Tremco.

D. Section 01600 - Product Requirements: Product Options: Substitutions permitted.

## 2.2 MISCELLANEOUS MATERIALS

- A. Joint Cleaner: Provide the type of joint cleaning compound recommended by the sealant manufacturer for the joint surfaces to be cleaned.
- B. Joint Primer / Sealer: Type of joint primer / sealer recommended by the sealant manufacturer for the joint surfaces to be primed or sealed.
- C. Bond Breaker Tape: Polyethylene tape or other plastic tape as recommended by the sealant manufacturer, to be applied to the sealant contact surfaces where bond to the substrate or joint filler must be avoided for proper performance of the sealant. Provide self-adhesive tape where applicable.

JOINT SEALERS

07900-7

D. Sealant Backer Rod: Compressible rod stock of polyethylene foam, polyethylene jacketed polyurethane foam, butyl rubber foam, neoprene foam or other flexible, permanent, durable, non-absorbable material as recommended by the sealant manufacturer for compatibility with the sealant.

E. Masking tape and similar accessories as necessary to protect adjacent surfaces from damage.

## 2.3 COLORS

A. Generally use sealant colors to match the color of the material in which the joint is located. Select from the manufacturer's standard colors.

B. Where a joint occurs between two materials of differing colors and the Contractor cannot determine which material to match, contact the Owner's representative for a decision.

## PART 3 EXECUTION

### 3.1 EXAMINATION

A. Section 01700 - Execution Requirements: Verification of existing conditions before starting the work.

B. Verification of Conditions: Verify that field measurements, surfaces, substrates and conditions are as required, and ready to receive the work.

1. Verify that joint widths are in conformance with the sealant manufacturer's allowable limits.

2. Verify that contaminants capable of interfering with adhesion have been cleaned from joints.

3. Verify that joints has been properly prepared.

C. Report, in writing, prevailing conditions that will adversely affect satisfactory execution of the work of this Section. Do not proceed with the work until the unsatisfactory conditions have been corrected.

### 3.2 JOINT PREPARATION

A. Prepare and size joints in accordance with the manufacturer's instructions.

B. Clean joint surfaces immediately before installation of sealant. Remove dust, dirt, laitance, unsecured coatings, mortar, moisture and other substances which could interfere with bond of sealant or caulking compounds using a solvent or abrasion as recommended by the manufacturer. Remove loose materials and foreign matter which could impair adhesion of the sealant.

C. Etch concrete and masonry joint surfaces as recommended by the sealant manufacturer.

D. Roughen vitreous and glazed joint surfaces as recommended by the sealant manufacturer.

E. Prime or seal joint surfaces where indicated, and where recommended by the sealant manufacturer.

JOINT SEALERS

07900-8

- F. Verify that the sealant is suitable for the substrate.
  - G. Verify that joint backing and release tapes are compatible with the sealant.
  - H. Verify that the sealant is paintable if a paint finish is indicated.
- 3.3 INSTALLATION
- A. Install in accordance with the manufacturer's printed instructions, except where more stringent requirements are shown or specified, and except where the manufacturer's technical representative directs otherwise. Perform the work in accordance with ASTM C 1193 for latex base sealants.
  - B. Prime or seal joint surfaces where recommended by the sealant manufacturer. Do not allow the primer or sealer to spill or migrate onto adjoining surfaces.
  - A. Set joint filler units at the proper depth or position to coordinate with other work, including the installation of bond breakers, backer rods and sealants. Do not leave voids or gaps between the ends of joint filler units.
  - B. Install sealant backer rods, except where shown to be omitted or recommended to be omitted by the sealant manufacturer for the application indicated.
  - C. Install pre-formed compressible and non-compressible fillers in accordance with the manufacturer's published instructions.
  - D. Install bond breaker tape where indicated and where required by the manufacturer's recommendations to ensure that elastomeric sealants will perform properly.
  - E. Employ only proven installation techniques which will ensure that the sealants are deposited in uniform, continuous ribbons without gaps or air pockets, foreign embedded matter, ridges and sags, with complete wetting<sup>®</sup> of joint bond surfaces equally on both sides.
  - F. Except as otherwise indicated, fill sealant rabbet to a slight concave surface, slightly below the adjoining surfaces. Where horizontal joints are between a horizontal surface and a vertical surface, fill the joint to form a slight cove so the joint will not trap moisture and foreign matter.
  - G. Dry tool joints. Do not use soap, water or solvent to tool the joints.
  - H. Seal joints before adjacent surfaces are waterproofed or painted.
  - I. Install sealants to the depths shown or, if not shown, as recommended by the sealant manufacturer, but within the following general limitations, measured at the center (thin section of the bead):
    1. For sidewalks, pavements and similar joints sealed with elastomeric sealants and subject to traffic and other abrasions and indentation exposures, fill the joints to a depth equal to 75% of the joint width, but not less than 3/8" deep or more than 1/2" deep.
    2. For normal moving joints sealed with elastomeric sealants not subject to traffic, fill joints to a depth equal to 50% of the joint width, but not less than 1/4" deep or more than 2" deep.

JOINT SEALERS

07900-9

JOINT SEALERS

07900-10

CENTRAL POLICE PRECINCT

- 3. For joints sealed with non-elastomeric sealants, fill the joints to a depth in the range of 75% to 125% of the joint width.
  - L. Epoxy Floor Joint Sealant: Install sealant at floor construction and control joints in accordance with the manufacturer's published instructions.
- 3.4 SPILLAGE
- A. Protect materials surrounding the work of this Section from damage and disfigurement. Do not allow sealants to overflow or spill onto adjacent surfaces, or to migrate into the voids of adjoining surfaces.
  - B. Recess exposed edges of exposed joint fillers slightly behind the adjoining surfaces, unless otherwise shown, so the compressed units will not protrude from the joints.
  - C. Bond ends of joint fillers together with an adhesive or weld<sup>®</sup> by other means recommended by the manufacturer to ensure a continuous watertight and airtight installation.
- 3.5 CURING
- A. Cure sealants in compliance with the manufacturer's published instructions.
- 3.6 FIELD QUALITY CONTROL
- A. Section 01450 - Quality Control: Field Inspection.
  - B. Inspect sealant work for proper installation, depth and adhesion.
- 3.7 CLEANING
- A. Section 01700 - Execution Requirements: Cleaning the installed work.
  - B. Remove excess and spillage of sealants promptly as the work progresses using the materials and methods recommended by the sealant and substrate manufacturers.
  - C. Clean adjoining surfaces to eliminate evidence of spillage without damage to the adjoining surfaces and finishes.
- 3.8 SEALANT SCHEDULE
- A. Exterior Joints:
    1. Perimeters of exterior openings where frames and other penetrations meet the exterior face of the building; precast concrete, concrete, concrete masonry, polymer reinforced concrete:
      - a. Sealant No. 2.1, C.1.b
    2. Expansion and control joints in exterior surfaces of cast-in-place concrete walls and precast architectural wall panels:
      - a. Sealant No. 2.1, C.1.b
      - b. Sealant No. 2.1, C.1.d

- c. Material No. 2.1, C.6.a
3. Expansion and control joints in exterior surfaces of unit masonry walls, polymer reinforced concrete and metal panels:
- a. Sealant No. 2.1, C.1.b
4. Coping joints, coping-to-facade joints, cornice and wash, and horizontal surface joints not subject to foot or vehicular traffic:
- a. Sealant No. 2.1, C.1.b
  - b. Sealant No. 2.1, C.1.d
5. Exterior joints in horizontal wearing and non-wearing surfaces:
- a. Sealant No. 2.1, C.1.a
  - b. Sealant No. 2.1, C.1.c
  - c. Material No. 2.1, C.6.a
6. Paving joints and curb:
- a. Sealant No. 2.1, C.1.d
  - b. Sealant No. 2.1, C.2.a
7. Setting bed for thresholds and saddles:
- a. Sealant No. 2.1, C.1.c
8. Painted metal lap and flashing joints:
- a. Sealant No. 2.1, C.2.a
- B. Interior Joints:
1. Seal the interior perimeters of exterior openings.
  2. Expansion and control joints on the interior of exterior cast-in-place concrete walls.
  3. Expansion and control joints on the interior of exterior precast, architectural wall panels.
  4. Expansion and control joints on the interior of exterior surfaces of unit masonry walls.
  5. Perimeters of interior aluminum and hollow metal frames.
  6. Interior masonry vertical control joints and intersecting unit masonry walls; masonry-to-masonry, masonry-to-concrete.
  7. For all of the above interior joints:
- a. Sealant No. 2.1, C.1.b
- b. Sealant No. 2.1, C.1.d
- c. Sealant No. 2.1, C.1.a (for pre-finished materials only).
8. Exposed interior control joints in drywall and concealed joints:
- a. Sealant No. 2.1, C.3.a
  - b. Sealant No. 2.1, C.4
  - c. Sealant No. 2.1, C.4.c
  - d. Sealant No. 2.1, C.6.a
9. Joints at the top of non-load-bearing unit masonry walls at the underside of cast-in-place concrete:
- a. Sealant No. 2.1, C.1.b
  - b. Sealant No. 2.1, C.1.d
10. Perimeters of architectural woodwork: overhead cabinets, base cabinets, vanities, countertops, shelving, etc.:
- a. Sealant No. 2.1, C.2.b
11. Perimeters of suspended acoustical ceilings where edge trim meets vertical surfaces:
- a. Sealant No. 2.1, C.2.b
12. Perimeters of toilet / bath fixtures: mirrors, sinks, urinals, tubs, vanities, waterclosets, accessories, etc.:
- a. Sealant No. 2.1, C.2.b
13. Interior expansion and control joints in floor surfaces exposed to foot traffic:
- a. Sealant No. 2.1, C.1.a
  - b. Sealant No. 2.1, C.1.c
  - c. Material No. 2.1, C.6.a
14. Interior saw-cut contraction joints in exposed concrete floors exposed to forklift traffic:
- a. Sealant No. 2.1 C.7
15. Interior non-moving joints, including control, contraction, and construction joints in interior floor slabs exposed to heavy duty traffic:
- a. Sealant No. 2.1, C.7
16. Painted metal lap joints:

JOINT SEALERS

07900-11

JOINT SEALERS

07900-12

SECTION 08100  
HOLLOW METAL DOORS AND FRAMES

- a. Sealant No. 2.1, C.2
- C. Glass and Glazing:
  - 1. Structural Glazing.
    - a. Sealant 2.1, C.2.a
  - 2. General Purpose Glazing.
    - a. Sealant 2.1, C.2.b
  - 3. End Damming.
    - a. Sealant 2.1, C.5

END OF SECTION

PART 1 GENERAL

1.1 SUMMARY

A. Section Includes:

1. Steel doors.
2. Steel door frames.
3. Steel window frames.
4. Door vision panels.
5. Louvers.
6. Accessories.

B. Related Documents: The Contract Documents, as defined in Section 01010 - Summary of Work, apply to the work of this Section. Additional requirements and information necessary to complete the work of this Section may be found in other Documents.

C. Related Sections:

1. Section 03300 - Cast-In-Place Concrete: Substrate for anchorage.
2. Section 04230 - Reinforced Unit Masonry: Substrate for anchorage.
3. Section 08210 - Wood Doors: Doors installed in steel frames.
4. Section 08710 - Door Hardware: Hardware coordination.
5. Section 08800 - Glass and Glazing: Glass installed in vision panels in doors and steel window frames.
6. Section 09900 - Painting: Field painting and finishing of frames and doors.

1.2 DESCRIPTION OF WORK

A. The extent of standard steel doors and frames work is indicated on the Drawings and Schedule and as specified herein, and includes providing and installing exterior entrance and storefront assemblies, designed and fabricated to comply with the requirements for system performance characteristics below, as demonstrated by testing of the manufacturer's corresponding stock systems in compliance with the test methods designated.

B. Door hardware is specified in Section 08710.

1.3 REFERENCES

A. The publications listed below form a part of this Specification to the extent referenced.

HOLLOW METAL  
DOORS AND FRAMES

08100-1

JOINT SEALERS

07900-13

- Publications are referred to in the text by basic designation only.
- B.** American Society of Civil Engineers (ASCE):
1. ASCE / SEI 7 - Minimum Design Loads for Buildings and Other Structures.
- C.** American Society for Testing and Materials (ASTM):
1. ASTM A 153 / A 153M - Specification for Zinc Coating (Hot-Dip) on Iron and Steel Hardware.
  2. ASTM A 568 / A 568M - Specification for Steel, Sheet, Carbon, Structural, and High-Strength, Low-Alloy, Hot-Rolled and Cold-Rolled, General Requirements for.
  3. ASTM A 653 / A 653M - Specification for Steel Sheet, Zinc-Coated (Galvanized) or Zinc-Iron Alloy-Coated (Galvannealed) by Hot-Dip Process.
  4. ASTM A 1008 / A 1008M - Specification for Steel, Sheet, Cold-Rolled, Carbon, Structural, High-Strength Low-Alloy, High-Strength Low-Alloy with Improved Formability, Solution Hardened, and Bake Hardenable.
  5. ASTM A 1011 / A 1011M - Specification for Steel, Sheet and Strip, Hot-Rolled, Carbon, Structural, High-Strength Low-Alloy, High-Strength Low-Alloy with Improved Formability, and Ultra-High Strength.
  6. ASTM D 2201 - Practice for Preparation of Zinc-Coated and Zinc-Alloy-Coated Steel Panels for Testing Paint and Related Coating Products.
  7. ASTM E 90 - Test Method for Laboratory Measurement of Airborne Sound Transmission Loss of Building Partitions and Elements.
  8. ASTM E 330 - Test Method for Structural Performance of Exterior Windows, Doors, Skylights and Curtain Walls by Uniform Static Air Pressure Difference.
  9. ASTM E 413 - Classification for Rating Sound Insulation.
- D.** Americans with Disabilities Guidelines (ADAAG):
1. Accessibility Guidelines for Buildings and Facilities.
- E.** Door Hardware Institute (DHI):
1. DHI - The Installation of Commercial Steel Doors and Steel Frames, Insulated Steel Doors in Wood Frames and Builder's Hardware.
- F.** International Code Council:
1. International Building Code (IBC), 2009.
- G.** Steel Door Institute (SDI):
1. SDI-100 - Standard Steel Doors and Frames.
  2. SDI-105 - Recommended Erection Instructions for Steel Frames.
- H.** National Fire Protection Association (NFPA):
1. Standard No. 80 - Standard for Fire Doors and Other Opening Protectives.
- 1.4 SUBMITTALS**
- A.** Section 01330 - Submittal Procedures: Procedures for submittals.
1. Product Data: Identify door and frame materials, gauges, configurations, location of cutouts, hardware reinforcement, fire-rating and finish.
  2. Shop Drawings: Include elevations of each door type, details of each frame type, conditions at openings, details of construction, location and installation requirements of reinforcements and finish hardware, and details of joints and connectors. Show anchorages and accessory items. Indicate door elevations, internal reinforcement, closure method, sidelights, and cutouts for louvers and vision panels.
  3. Schedule: Provide for doors and frames using the same reference numbers for details and openings as those used on the Drawings.
  4. Samples: Full range of color samples for selection. Two (2) 6" x 6", minimum, of each color and texture selected from factory-finished doors and frames.
  5. Assurance / Control Submittals:
    - a. Certificates:
      - 1) Manufacturer's Certificate that the products meet or exceed the specified requirements.
      - 2) Manufacturer's certification that hot-dip galvanizing for doors and frames comply with the requirements.
      - 3) Manufacturer's certification that oversized fire-rated frame and door assemblies have been constructed with materials and methods equivalent to the requirements for labeled construction.
    - b. Calculations indicating that exterior doors, frames and anchorages satisfy the performance requirements.
    - c. Documentation of experience indicating compliance with the specified qualifications requirements.
- B.** Section 01780 - Closeout Submittals: procedures for closeout submittals.
1. Warranty: Submit a written special Warranty with forms completed in the name of the Owner and registered with the manufacturer.
- 1.5 QUALITY ASSURANCE**
- A.** Qualifications:
1. Manufacturer: Company specializing in manufacturing the products specified with a minimum of five (5) years documented experience.
  2. Installer: Company experienced in performing work of this Section with a minimum of five (5) years documented experience.

HOLLOW METAL DOORS AND FRAMES 08100-2

HOLLOW METAL DOORS AND FRAMES 08100-3



3. Provide frames and doors complying with Steel Door Institute, SDI-100 Recommended Specifications: Standard Steel Doors and Frames® and as specified herein.
- B. Performance Requirements:
1. Provide the capacity to withstand the following loading requirements for exterior units:
    - a. Design and install to resist combined positive and negative windloading in accordance with IBC 2009, Section 1609 with a Vmph of 170, qs of 74.0 psf, exposure [B][C][D], and importance factor [1.0][1.25][1.5], as applicable per ASCE 7.
  2. Fire-Rated Assemblies: Provide fire-rated doors investigated and tested as fire door assemblies, complete with type of hardware to be used. Identify each fire door with recognized testing laboratory labels indicating the applicable fire-rating. Construct and install assemblies to comply with NFPA, Standard No. 80, and as herein specified.
- 1.6 DELIVERY, STORAGE AND PROTECTION
- A. Section 01600 - Product Requirements: Transport, handle, store, and protect the products.
  - B. Deliver hollow metal work cartoned or crated for protection during transit and storage.
  - C. Provide additional sealed plastic wrapping for factor-finished doors.
  - D. Deliver products to the Project Site in the manufacturer's original, unopened packages, dry and undamaged with seals and labels intact.
  - E. Inspect products for damage. Minor damages may be repaired provided the finish items are equal, in all respects, to new work, and acceptable to the Owner's representative; otherwise remove and replace the damaged items.
  - F. Store under cover in dry, weathertight conditions. Place units on 4" high wood sills or store otherwise in a manner to prevent rust and damage. Provide 1/4" space between stacked doors to allow for air circulation. Avoid the use of non-ventilated plastic or canvas shelters. If the cardboard wrapper becomes wet, remove the carton immediately.
  - G. Break seals to permit ventilation.
- 1.7 WARRANTY
- A. Section 01780 - Closeout Submittals: Procedures for closeout.
  - B. Special Warranty:
    1. Provide a written Warranty, signed by the door manufacturer, and the door installer agreeing to repair or replace doors that do not meet the requirements, or that fail in materials or workmanship.
    2. Warranty Period: Two (2) years from the date of Substantial Completion.

PART 2 PRODUCTS  
HOLLOW METAL  
DOORS AND FRAMES

08100-4

2.1 MANUFACTURERS

- A. Subject to compliance with the Project requirements, manufacturers offering items which may be incorporated in the work include the following:
1. Amweld Building Products.
  2. Ceco Door Products.
  3. Republic Doors and Frames.
  4. Steelcraft.
  5. Curries.
- B. Section 01600 - Product Requirements: Product Options: Substitutions permitted.

2.2 MATERIALS

- A. Hot-Rolled Steel Sheets and Strip: Commercial quality carbon steel, pickled and oiled, complying with ASTM A 1011 / A 1011M and ASTM A 568 / A 568M.
- B. Cold-Rolled Steel Sheets: Commercial quality carbon steel, complying with ASTM A 1008 / A 1008M and ASTM A 568 / A 568M.
- C. Galvanized Steel Sheets: Zinc-coated carbon steel sheets of commercial quality, complying with ASTM A 653 / A 653M, ASTM D 2201, G60 zinc coating, mill phosphatized.
- D. Supports and Anchors: Fabricate of not less than 18 gage galvanized sheet steel.
- E. Inserts, Bolts and Fasteners: Manufacturer's standard units, hot-dip galvanized complying with ASTM A 153 / A 153M, Class C or D, as applicable.

2.3 FABRICATION

- A. Fabricate units rigid, neat in appearance, and free from defects, warp, twist and buckle. Fit and assemble units in the manufacturer's plant. Fabricate KD or welded. Clearly identify work that cannot be permanently factory-assembled before shipment to assure proper assembly at the Project Site.
- B. Weld the exposed surface of joints continuously; grind, dress, and make joints smooth, flush and invisible. When prime painted, the use of metallic filler to conceal manufacturing defects is not acceptable.
- C. Fabricate exposed faces of doors and panels, including stiles and rails of non-flush units from only cold-rolled steel.
- D. Fabricate frames, concealed stiffeners, reinforcement, edge channels, louvers and molding from either cold-rolled or hot-rolled steel (fabricator's option), galvanized.
- E. Fabricate doors, panels and frames from galvanized sheet steel. Close top and bottom edges of doors as an integral part of the door construction or by the addition of inverted steel channels.
- F. Exposed Fasteners: Unless otherwise indicated, provide countersunk flat Phillips head for exposed screws and bolts; galvanized.

HOLLOW METAL  
DOORS AND FRAMES

08100-5

1. Cold-rolled steel; factory mitered corners and full-welded construction; 2" face, jamb dept as required or as shown on the Drawings; galvanized to ASTM D 2201.
  2. 14 gage for exterior frames and other frames wider than 48".
  3. 18 gage for all other frames.
- C. Interior Frames:
1. Cold-rolled steel; 2" face, jamb depth as required or as shown on the Drawings.
  2. 16 gage.
  3. Fire-rated frames per NFPA, Standard No. 80.
- D. Silencers: Except on weatherstripped frames, drill stops to receive three (3) silencers on the strike jambs of single-swing frames and two (2) silencers on the heads of double-swing frames. Install plastic plugs to keep holes clear during construction.
- E. Plaster Guards: Provide 26 gage, steel plaster guards or mortar boxes welded to the frames at the back of door hardware cutouts where mortar or other materials might obstruct hardware operation.
- F. Anchors: Equip frames with one welded-in floor anchor in each jamb. Furnish a minimum of three (3) steel jamb anchors and two (2) head anchors for field insertion at a maximum of 24" o.c. Anchors shall be of the proper type for the particular construction involved, i.e., concrete, masonry, metal framing, etc. Conceal fastenings unless indicated otherwise.

#### 2.5 STANDARD STEEL DOORS

- A. Exterior Doors: Extra Heavy-Duty, Grade III per SDI-100, 1-3/4" thick, types and styles as indicated on the Drawings; top edge closed flush; 14 gage cold-rolled steel, galvanized to ASTM D 2201; insulated core.
- B. Interior Doors: Standard-duty, Grade I per SDI-100, 1-3/4" thick, types and styles as indicated on the Drawings; top edge closed flush; 16 gage cold-rolled steel. Fire-rated UL labeled where indicated or required by the Building Code.
- C. Fire-Rated Doors: Per NFPA, Standard No. 80.
- D. Vision Panels: Laminated glass in metal frames as required by the fire-rating. Install removable steel stops on the room side of the doors.
- E. Louvers:
1. Exterior: Weatherproof, stationary, where shown on the Drawings. Construct of AZ<sup>80</sup> shaped, 16 gage, hot-dip galvanized steel blades. Space blades not more than 1-1/2" o.c. Provide removable 1/4" stainless steel wire mesh screen at the interior face of doors, in formed metal frame with removable clips. Provide insect screens at louvers in exterior doors.
  2. For fire-rated openings, provide tightly fitted, spring-loaded, automatic closing louvers with operable blades equipped with a fusible link; arranged so metal overlaps metal at every joint.
  3. Provide louvers complying with UL or NFPA standards only, and factory-applied in doors.

HOLLOW METAL  
DOORS AND FRAMES

08100-7

#### G. Sound-Rated (Acoustical) Assemblies:

1. Where shown or scheduled, provide frame and door assemblies which have been fabricated as sound-reducing type, tested in accordance with ASTM E 90 and classified in accordance with ASTM E 413.

2. Unless otherwise indicated, the minimum sound rating for acoustical assemblies shall be STC 33.

#### H. Door Hardware Preparation:

1. Prepare doors and frames to receive mortised and concealed finish hardware in accordance with final Finish Hardware Schedule and templates provided by the hardware supplier. Comply with applicable requirements of ANSI A115 series specifications for door and frame preparation for hardware.
2. For concealed overhead door closers, provide space, cutouts, reinforcing and provisions for fastening in the top rail of doors or heads of frames, as applicable.
3. Reinforce doors and frames to receive surface-applied hardware. Drilling and tapping for surface-applied finish hardware may be done at the Project site.
4. Locate finish hardware as shown on final Shop Drawings or, if not shown, in accordance with Recommended Locations for Builder's Hardware, published by the Door and Hardware Institute and ADA Accessibility Guidelines.

I. Prepare frame for silencers. Provide three single rubber silencers for single doors; two single silencers on the frame head at double doors without mullions.

J. Equip frames with one welded-in floor anchor in each jamb. Furnish a minimum of three (3) steel jamb anchors and two (2) head anchors for field insertion at a maximum of 24" o.c. Anchors shall be of the proper type for particular construction involved (i.e., masonry, concrete, metal framing, etc).

K. Factory install louvers and vision panels in prepared openings.

#### L. Shop Painting:

1. Clean steel surfaces of mill scale, rust, oil, grease, dirt, and other foreign materials before application of paint.
2. Clean, treat and paint exposed surfaces of steel doors, louvers and frames including galvanized surfaces.
3. Apply one shop coat of rust-inhibitive enamel or primer paint, either air-dried or baked-on, of even consistency, and suitable as a base for the specified finish paint.

#### 2.4 STANDARD STEEL FRAMES

A. Provide galvanized steel frames for doors, transoms, sidelights, borrowed lights, windows and other openings of the types and styles shown on the Drawings.

B. Exterior Frames including sidelights, if required:

HOLLOW METAL  
DOORS AND FRAMES

08100-6

4. Interior (Non-fire-rated): Roll-formed, 20 gage, galvanized steel, inverted AY® blades, sight-proof, prime painted for field applied finish paint; size as indicated on the Drawings.
- 2.6 CORE CONSTRUCTION
- A. Provide one of the following types of core construction (Contractor's option):
1. Kraft Honeycomb; Phenolic treated.
  2. Polyurethane: Foamed-in-place or laminated. 20 psi strength, 1.8 pcf density, 1/2" maximum voids in any direction. Strength of bond between the core and the steel face sheets shall exceed strength of core so delamination will not occur during operating conditions.
  3. Polystyrene: Rigid core of polystyrene foam board, 1500 psf compressive strength, 18 psi shear strength. Strength of the bond between the core and the steel face sheets shall exceed strength of core so that delamination will not occur under operating conditions.
  4. Vertical Steel Stiffeners: 22 gage vertical steel stiffeners, spaced 6" apart and spot welded to the face sheets at 6" on center. Insulate the spaces between stiffeners with loose fill insulation the full height of the door.

### 2.7 PROTECTIVE COATINGS

- A. Bituminous Coating: Apply fibered asphalt emulsion at grout filled frames.
- B. Primer: Exposed surfaces shall be cleaned, treated with Bonderite chemical and given one baked-on shop coat of grey synthetic primer.

### PART 3 EXECUTION

#### 3.1 EXAMINATION

- A. Section 01700 - Execution Requirements: Verification of existing conditions before starting the work.
- B. Verification of Conditions: Verify that field measurements, surfaces, substrates and conditions are as required, and ready to receive the work.
- C. Report in writing, prevailing conditions that will adversely affect satisfactory execution of the work of this Section. Do not proceed with the work until the unsatisfactory conditions have been corrected.

#### 3.2 INSTALLATION

- A. General: Install standard steel doors, frames and accessories in accordance with the final Shop Drawings, the manufacturer's published instructions, as herein specified, and at the locations shown on the Drawings.
- B. Door Installations:
1. Fit hollow metal doors accurately in frames, within clearances specified in SDI-100.

HOLLOW METAL  
DOORS AND FRAMES

08100-8

2. Install fire-rated doors with the clearances specified in NFPA, Standard No. 80.
- C. Frame Installations:

1. Comply with the provisions of SDI-105. Recommended Erection Instructions for Steel Frames®, unless indicated otherwise.
2. Except for frames located at in-place concrete or masonry and at drywall installations, place frames prior to construction of the enclosing walls. Set frames accurately in position, plumbed, aligned, and braced securely until permanent anchors are set. After the wall construction is completed, remove temporary braces and spreaders leaving the surfaces smooth and undamaged.
3. At in-place concrete construction, set frames and secure to adjacent construction with machine screws and masonry anchorage devices.
4. In masonry construction, locate wall anchors at the hinge and strike levels. Building-in of anchors and grouting of frames is specified in Division 4 and as shown on the Drawings..
5. In steel framed partitions, install wall anchors at the hinge and strike levels. In open steel stud partitions, place studs in wall anchor notches and wire tie. In closed steel stud partitions, attach wall anchors to studs with tapping screws.
6. Install fire-rated frames with clearances specified in NFPA, Standard No. 80.

- D. Field Finish: Field paint door, frames, louvers and vision panel frames as specified in Section 09900 - Painting.

### 3.3 CONSTRUCTION

#### A. Interface with Other Work:

1. Coordinate frame installations for size, location, and the particular construction involved.
2. Coordinate with the door opening construction, door frames, door hardware, door louver and vision panel glazing installation.

#### B. Site Tolerances:

1. Maximum Diagonal Distortion: 1/16" measured with straight edge from corner to corner.

### 3.4 ADJUSTING

- A. Section 01700 - Execution Requirements: Adjusting the installed work.
- B. Immediately after installation, sand smooth any rusted or damaged areas of the prime coat and touch-up with a compatible air-drying primer.
- C. Check and readjust operating door hardware items. Leave steel doors and frames undamaged and in complete and proper operating condition.
- D. Adjust hardware for smooth and balanced door and window movement.

HOLLOW METAL  
DOORS AND FRAMES

08100-9

CENTRAL POLICE PRECINCT

3.5 FIELD QUALITY CONTROL

- A. Section 01450 - Quality Control: Field inspection.
  - B. Inspect metal door, frame and window installations, alignment, attachment to structure, and operation.
- 3.6 CLEANING
- A. Section 01700 - Execution Requirements: Cleaning installed Work.
  - B. Immediately prior to final inspection, remove protective plastic wrappings from prefinished doors.
  - C. Wipe down all doors and frames before final acceptance inspection.

END OF SECTION

SECTION 08210  
WOOD DOORS

PART 1 GENERAL

1.1 SUMMARY

A. Section Includes:

1. Flush solid core wood doors with wood veneer.
2. Flush solid core wood doors with plastic laminate face.
3. Flush hollow core wood doors with veneer face.
4. Paneled wood doors with solid wood stiles, rails and panels.
5. Furnishing and installation of louvers in wood doors.

B. Related Documents: The Contract Documents, as defined in Section 01010 - Summary of Work, apply to the work of this Section. Additional requirements and information necessary to complete the work of this Section may be found in other Documents.

C. Related Sections:

1. Section 06200 - Finish Carpentry: Wood door frames.
2. Section 08710 - Door Hardware: Hardware coordination for wood doors.
3. Section 08800 - Glass and Glazing: Glass installed in wood doors.
4. Section 09900 - Painting: Field painting of wood doors.

1.2 DESCRIPTION OF WORK

A. The extent of the wood doors work is indicated on the Drawings and Schedules and as specified herein, and includes providing and installing standard hollow core and solid core wood doors, panel doors and louvers.

1.3 REFERENCES

- A. The publications listed below form a part of this Specification to the extent referenced. Publications are referred to in the text by basic designation only.
- B. American Society of Civil Engineers (ASCE):
  1. ASCE / SEI 7 - Minimum Design Loads for Buildings and Other Structures.
- C. Americans with Disabilities Act Accessibility Guidelines (ADAAG):
  1. Accessibility Guidelines for Buildings and Facilities.
- D. National Electrical Manufacturers Association (NEMA):

HOLLOW METAL  
DOORS AND FRAMES

08100-10

WOOD DOORS

08210-1

1. NEMA LD-3 - High Pressure Decorative Laminates.
- E. Architectural Woodwork Institute (AWI):
1. Architectural Woodwork Quality Standards, Guide Specifications and Quality Certification Program.
  2. AWI 1300 - Architectural Flush Doors.
- F. International Code Council:
1. International Building Code (IBC), 2009.
- G. National Wood Window and Door Association (NWWDA):
1. I.S.-1. A Industry Standard for Wood Flush Doors®.
- H. National Woodwork Manufacturers Association (NWWMA).
1. aCare and Finishing of Wood Doors®.
- I. Woodwork Institute (WI):
1. aManual of Millwork® - Designations for wood door grades and core construction.
- 1.3 SUBMITTALS
- A. Section 01330 - Submittal Procedures: Procedures for submittals.
1. Product Data: Door, manufacturer's product data, specifications and installation instructions for each type of door. Include details of core and edge construction, and louvers, if any, and similar components.
  2. Shop Drawings: Indicate locations and size of each door, elevation of each kind, details of construction, locations and extent of hardware blocking, swings, and other pertinent information. Indicate cutouts for vision panels and louvers, if any.
  2. Samples: For review and approval of color and texture only. Compliance with other requirements is the exclusive responsibility of the Contractor. Submit the following:
    - a. 8" x 10" representative finished veneer sheet for each available flitch to be used for face veneer of transparent finished doors.
    - b. 3" x 10" solid wood strips of species to be used for exposed edges, trim and other solid wood components.
  3. Assurance / Control Submittals:
    - c. Manufacturer's certificate that the products meet or exceed the specified requirements.
    - d. Documentation of experience indicating compliance with the specified qualifications requirements.
- B. Section 01780 - Closeout Submittals: Procedures for closeout submittals.
1. Special Warranty: Submit written special Warranty forms completed in the name

WOOD DOORS

08210-2

of the Owner and registered with the manufacturer.

1.4 QUALITY ASSURANCE

- A. Qualifications:
1. Manufacturer: Company specializing in manufacturing the products specified with a minimum of five (5) years documented experience.
- B. Obtain doors from a single manufacturer to ensure uniformity in quality of appearance and construction, unless approved otherwise.
- C. Mark each door with NWWDA, Wood Flush Door Certification Hallmark certifying compliance with applicable requirements of ANSI / NWWDA I.S.-1. For manufacturer's not participating in the NWWDA Hallmark Program, a certification of compliance may be substituted for marking of the individual doors.
- D. Perform Work in accordance with AWI 1300 for Custom Grade doors.
- F. Performance Requirements:
1. Fabricate and install to withstand the following loading requirements for exterior units:
    - a. Combined positive and negative windloading in accordance with IBC 2009, Section 1609 with a Vmph of 170, qs of 74.0 psf, exposure [B] [C] [D], and importance factor of [1.0] [1.25] [1.5], as applicable per ASCE 7.

1.5 DELIVERY, STORAGE AND HANDLING

- A. Section 01600 - Product Requirements: Transport, handle, store and protect doors from damage, soiling and deterioration.
- B. Ship doors individually wrapped.
- C. Deliver products to the Project Site in the manufacturer's original, unopened packaging, dry and undamaged with seals and labels intact.
- D. Comply with the aOn-Site Care® recommendations of NWWMA pamphlet aCare and Finishing of Wood Doors® and with the manufacturer's instructions.
- E. Store under cover in dry, weathertight conditions.

1.6 COORDINATION

- A. Design intent: It is the intent of the design that similar woodwork throughout the Project match. Coordinate work between the separate installers providing similar woodwork to ensure that the design intent is achieved to the satisfaction of the Owner's representative.
- B. Pre-Construction Meetings: Prior to the purchase and fabrication of materials and prior to installation of the scheduled work, conduct meetings with the various related woodwork installers to coordinate efforts to achieve the design intent. Participants to include the Contractor, finish carpentry installer, architectural woodwork installer, painting applicator and the Owner's representative.

1.7 JOB CONDITIONS

WOOD DOORS

08210-3

- 1.8 WARRANTY
- A. Condition doors to the average prevailing humidity in the installation areas prior to installation.
- B. Special Warranty:
1. Provide a written Warranty, signed by the door manufacturer agreeing to repair or replace doors that do not meet the requirements, or that fail due to delamination of veneer, warping beyond the specified installation tolerances, defective materials or telegraphing of the core construction.
  2. Warranty Period:
    - a. Exterior Doors: Two (2) years from the date of Substantial Completion.
    - b. Interior Doors: Life of the installation.
    - c. Stile and Rail Doors: Fabricator's special warranty for two (2) years against defects in materials and workmanship including, but not limited to, defects against warpage and wracking.
- PART 2 PRODUCTS
- 2.1 MANUFACTURERS
- A. Subject to compliance with the Project requirements, manufacturers offering products which may be incorporated into the work include the following:
1. Cal-wood Door Div., Timberland Industries.
  2. Eggers Industries, Architectural Door Div.
  3. Mohawk Flush Doors, Inc.
  4. Weyerhaeuser Co.
  5. SUN-DOR-CO.
- B. Section 01600 - Product Requirements: Product Options: Substitutions permitted.
- 2.2 MATERIALS
- A. Solid Core Wood Doors (interior doors): AWI 1300.
1. Type: Institutional, flush, solid core wood, AWI, [premium][custom] grade.
  2. Thickness: As indicated on the Drawings.
  3. Core: Mat-formed wood particleboard with closed grain hardwood stiles, commercial Standard CS 236-66, Type 1, Density  $\Delta$ C<sub>66</sub>, Class 1, Minimum 30 pounds per cubic foot density. Mineral core with UL label for fire-rated doors.

4. Face Finish: Veneer shall be premium grade sliced hardwood for doors with a transparent finish; custom grade, medium density overlay for doors scheduled for paint finish; conform to commercial standard CS35; minimum, 1/8" thick. Wood species as selected. Plastic laminate where indicated.
  5. Stiles and Rails: One piece hardwood stiles and top and bottom rails with wood species to match the face veneer. Where door closers are specified, the top rail width shall be doubled.
    - a. The bottom rail of a transom panel shall run the full width of the panel.
  6. Plastic Laminate: High pressure laminate. Color and texture as selected.
- B. Hollow Core Wood Doors:
1. Type: Institutional, flush hollow core, AWI, [premium][custom] grade.
  2. Thickness: As indicated on the Drawings.
  3. Core: Expanded corrugated core with wood lock blocks.
  4. Face Finish: Veneer shall be premium grade, plain sliced hardwood for doors with a transparent finish; custom grade, medium density overlay for doors scheduled for paint finish. Wood species as selected.
  5. Plastic Laminate: High pressure laminate. Color and texture as selected.
- C. Panel Doors:
1. Type: Custom fabricated, solid wood construction. AWI, [premium][custom] grade.
  2. Stiles, Rails and Panels: Fabricated from clear, kiln dried solid lumber core with sliced veneer faces and edges as scheduled and solid trim pieces as required. Wood species as scheduled or selected. Vertical stiles shall be of the same species and color as the face veneer.
- D. Lowered / Half-Louvered Doors: Minimum 1-3/8" thick; conform to NWWDA, I.S.-6.
- E. Louvers:
1. Wood: Door manufacturer's standard solid wood louvers of the same species as the door face veneer, unless indicated otherwise and of the size, type and profile shown. Factory install in prepared openings.
- F. Transom and Side Panels: Where transom or side panels are shown in the same framing system as wood doors, provide panels which match the quality and appearance of the associated wood doors, unless otherwise indicated. Fabricate matching panels with the same construction, exposed surfaces and finish as specified for the associated doors.
- G. Adhesive: Type 1, waterproof bond.
- 2.3 FABRICATION
- A. Fabricate non-fire-rated doors in accordance with AWI 1300.
  - B. Furnish and install lock blocks at lock edge, and at the top of doors for closer hardware reinforcement.

WOOD DOORS 08210-4

WOOD DOORS 08210-5

- C. Bond edge banding to the core.
  - D. Factory machine doors for door hardware in accordance with the hardware requirements and dimensions. Do not machine for surface hardware.
  - E. Factory install louvers in prepared openings.
  - F. Factory fit doors for the frame opening dimensions identified on the approved Shop Drawings.
  - G. Doors may be provided pre-fitting, set in frames and ready for installation in rough openings.
  - H. Before delivery of doors to the Project Site, shop-prime all wood surfaces per Section 09900 - Painting.
- PART 3 EXECUTION**
- 3.1 EXAMINATION**
- A. Section 01700 - Execution Requirements: Verification of existing conditions before starting the work.
  - B. Verification of Conditions: Verify that field measurements, surfaces, substrates and conditions are as required, and ready to receive the work.
  - C. Installer must examine door frames and verify that the frames are the correct type and have been installed as required for the proper hanging of corresponding doors.
  - D. Report, in writing, prevailing conditions that will adversely affect satisfactory execution of the work of this Section. Do not proceed with the work until the unsatisfactory conditions have been corrected.
- 3.2 INSTALLATION**
- A. Condition doors to average prevailing humidity in the installation areas prior to hanging.
  - B. Install wood doors in accordance with the manufacturer's instructions and as shown.
  - C. Install non-fire-rated doors in accordance with AWI Quality Standards requirements.
  - D. Job Fit Doors: Align doors to the frames for proper fit and uniform clearance at each edge and machine for hardware. Seal cut surfaces after fitting and machining.
    - 1. Bevel non-fire rated doors 1/8" in 2" at lock and hinge edges.
  - E. Machine cut doors for the hardware. Install the door hardware specified in Section 08710.
  - F. Clearance: For non-fire rated doors provide a clearance of 1/8" at jambs and heads, 1/8" at meeting stiles for pairs of doors, and 3/16" from the bottom of the door to the top of decorative floor finish or covering. Where thresholds are shown or scheduled, provide 1/4" clearance from the bottom of the door to the top of the threshold.
  - G. Tolerance: Conform to AWI 1300 for requirements for maximum diagonal warp.

WOOD DOORS

08210-6

WOOD DOORS

08210-7

CSI MASTER

- H. Install door louvers plumb and level.
  - I. Job Site Finished Doors: For requirements for finishing wood doors, louvers and vision panel frames see Section 09900 - Painting.
- 3.3 ADJUSTING**
- A. Section 01700 - Execution Requirements: Adjusting and cleaning the installed work.
  - B. Rehang or replace doors which do not swing or operate smoothly.
- 3.4 FIELD QUALITY CONTROL**
- A. Section 01450 - Quality Control: Field inspection.
  - B. Inspect door installations for alignment, hardware installations and door operation.
- 3.5 PROTECTION**
- A. Section 01700 - Execution Requirements: Protecting the installed work.
  - B. Implement procedures for the protection of installed wood doors from damage and deterioration until final acceptance.
  - C. Refinish or replace doors damaged during installation as directed by the Owners representative.

END OF SECTION

SECTION 08310  
ACCESS DOORS AND PANELS

PART 1 GENERAL

1.1 SUMMARY

A. Section Includes:

1. Access door and frame units.
2. Wall- and ceiling-mounted locations.

B. Related Documents: The Contract Documents, as defined in Section 01010 - Summary of Work, apply to the work of this Section. Additional requirements and information necessary to complete the work of this Section may be found in other Documents.

C. Related Sections:

1. Section 03300 - Cast-In-Place Concrete: Substrate for anchorage.
2. Section 04230 - Reinforced Unit Masonry: Substrate for anchorage.
3. Section 09110 - Non-Load Bearing Steel Framing: Wall and ceiling framing for attachment of units.
4. Section 09250 - Gypsum Board: Adjacent wall and ceiling finish material.
5. Section 09900 - Painting: Field painting of door and frame units.

1.2 DESCRIPTION OF WORK

A. The extent of access door work is indicated on the Architectural, Mechanical, Plumbing and Electrical Drawings and as specified herein, and includes providing and installing access doors where access to mechanical, plumbing and electrical items is required, whether or not the access doors are shown on the Drawings.

1.3 REFERENCES

A. The publications listed below form a part of this Specification to the extent referenced. Publications are referred to in the text by basic designation only.

B. American Society for Testing and Materials (ASTM):

1. ASTM A 153 / A 153M - Specification for Zinc Coating (Hot-Dip) on Iron and Steel Hardware.
2. ASTM A 568 / A 568M - Specification for Steel, Sheet, Carbon, Structural, and High-Strength, Low-Alloy, Hot-Rolled and Cold-Rolled, General Requirements for.
3. ASTM A 653 / A 653M - Specification for Steel Sheet, Zinc-Coated (Galvanized) or Zinc-Iron Alloy-Coated (Galvannealed) by Hot-Dip Process.

4. ASTM A 1008 / A 1008M - Specification for Steel, Sheet, Cold-Rolled, Carbon, Structural, High-Strength Low-Alloy, High-Strength Low-Alloy with Improved Formability, Solution Hardened, and Bake Hardenable.

5. ASTM A 1011 / A 1011M - Specification for Steel, Sheet and Strip, Hot-Rolled, Carbon, Structural, High-Strength Low-Alloy, High-Strength Low-Alloy with Improved Formability, and Ultra-High Strength.

6. ASTM D 2201 - Practice for Preparation of Zinc-Coated and Zinc-Alloy-Coated Steel Panels for Testing Paint and Related Coating Products.

C. National Fire Protection Association (NFPA):

1. Standard No. 80 - Standard for Fire Doors and Other Opening Protectives.

1.4 SUBMITTALS

A. Section 01330 - Submittal Procedures: Procedures for submittals.

1. Product Data: Manufacturer's technical data and installation instructions for each type of access door assembly, including setting drawings, templates, instructions and directions for installation of anchorage devices.

2. Shop Drawings: Indicate the location, size, type, finish, hardware, and details of adjoining work for all access door units.

3. Schedule: Indicate all doors by type, size, rating and location keyed to the Drawings.

3. Assurance / Control Submittals:

- a. Manufacturer's certificate that products meet or exceed the specified requirements.
- b. Documentation of experience indicating compliance with the specified qualifications requirements.

B. Section 01780 - Closeout Submittals: Procedures for closeout submittals.

1. Project Record Documents: Accurately record the location of all access units.
2. Warranty: Submit a written special Warranty with forms completed in the name of the Owner and registered with the manufacturer.

1.5 QUALITY ASSURANCE

A. Qualifications:

1. Manufacturer: Company specializing in manufacturing the products specified with a minimum of five (5) years documented experience.

B. Fire-Resistance Ratings: In all Corridor walls, rated partitions and ceilings, provide access door assemblies with panel door, frame, hinge, and latch from a manufacturer listed in Underwriter's Laboratories, Inc.; Classified Building Materials Index® for 90 minutes rating.

ACCESS DOORS AND PANELS

08310-8

ACCESS DOORS AND PANELS

08310-2

CENTRAL POLICE PRECINCT



1. Provide UL label on each fire-rated access door.
- C. Size Variation: The selected manufacturer's standard units may vary in size slightly from the sizes indicated herein. Secure the Owner representative's approval for sizes that differ from the units specified.
- D. Coordination: Furnish inserts and anchoring devices which must be built into other work for the installation of access doors. Coordinate delivery with other trades to avoid delaying the work.
- 1.6 DELIVERY, STORAGE AND HANDLING
- A. Section 01600 - Product Requirements: Transport, handle, store, and protect the products.
- B. Deliver products to the Project Site in the manufacturer's original, unopened packaging, dry and undamaged with seals and labels intact.
- C. Handle and store to prevent damage to frames, panels and operating mechanisms.
- 1.7 WARRANTY
- A. Section 01780 - Closeout Submittals: Procedures for closeout.
- B. Special Warranty:
1. Provide a written Warranty, signed by the manufacturer, and the Installer agreeing to repair or replace doors and panels that do not meet the requirements, or that fail in materials or workmanship.
  2. Warranty Period: Two (2) years from the date of Substantial Completion.

## PART 2 PRODUCTS

### 2.1 MANUFACTURERS

- A. Subject to compliance with the Project requirements, manufacturers offering products which may be incorporated into the work include the following:
1. J. L. Industries, Inc.
  2. Karp Associates, Inc.
  3. Larsen's Manufacturing Co.
  4. Milcor (Gibraltar Building Products).
- B. Section 01600 - Product Requirements: Product Options: Substitutions permitted.

### 2.2 ACCESS DOORS

- A. General: Manufacturer's standard fully-welded steel construction. Provide units with means for anchoring properly to the adjacent construction.
- B. Non-Fire-Rated Units:

ACCESS DOORS AND PANELS 08310-3

1. Doors:
    - a. Flush Units: 14 gage, minimum.
    - b. Recessed Units: 18 gage, minimum.
  2. Hinges: Stainless steel, piano or pin type, concealed and continuous, 175 degrees opening, constant force closure, spring type.
  3. Operation: Flush screw driver slot for quarter turn cam latch with welded steel access sleeves at recessed panel doors.
- C. Fire-Rated Units: As required for the fire-rating, but not less than the following:
1. Doors: Steel-faced, insulated core panel, 20 gage minimum.
  2. Hinges: Stainless steel, piano or pin type, concealed and continuous, 175 degrees opening, constant force closure with spring or other self-closing mechanism.
  3. Operation: Flush screw driver slot for quarter turn cam latch.
- D. Unit Construction Types:
1. Non-Fire-Rated:
    - a. Flush: Flush door with bead to give the unit a frameless appearance.
    - b. Recessed: Recessed door to allow installation of acoustical tile, gypsum board or similar finish into the recess to provide a concealed appearance. Units for plaster or mortarbed to have integral expanded metal lath.
    - c. Universal: Flush door with exposed frame. Exposed flange of frame not to exceed 1" in width.
  2. Fire-Rated: Flush insulated door with exposed frame. Exposed flange of frame not to exceed 1" in width, unless approved otherwise.

### 2.3 FABRICATION

- A. General: Fabricate each access door assembly as an integral unit, complete, with all necessary parts, and ready for installation.
- B. Steel Access Doors and Frames: Fabricate units of continuous welded steel construction. Fill and grind welds smooth and flush with adjacent surfaces. Fabricate units square. Furnish attachment devices and fasteners of the type required to secure the units to the adjacent substrate. All doors in fire-rated assemblies shall have been tested and have a Class B, 1-1/2 hour fire-rating label attached.
- C. Frames and Flanges:
1. Fabricate frames from 16 gage steel, minimum, with exposed flanges approximately 1" in width around the perimeter of the frame for units to be installed in the following construction types, except as noted:
    - a. Exposed concrete.
    - b. Exposed masonry.

ACCESS DOORS AND PANELS 08310-4

- c. Gypsum board.
  - d. Plaster.
  - e. Ceramic tile.
  - f. Wood paneling, flush type with wood inlay to match the adjacent panel.
- 2. For installation in masonry construction, fabricate frames with adjustable metal masonry anchors.
  - 3. For installation in plaster finish, fabricate frames with galvanized expanded metal lath, and exposed casing bead welded to the perimeter of the frame.
- D. Access doors and frames for installation in concrete, masonry, plaster and ceramic tile shall be flush, stainless steel; #4 satin finish: Model DSC-214M by Karp Associates or approved equal.
  - E. Access doors for installation in gypsum board shall be concealed frame, recessed; finish as selected: Model KDW by Karp Associates or approved equal.
  - F. For recessed panel doors, provide access sleeves for each locking device. Furnish plastic grommets. Install in a hole cut thru the finish material.
  - G. Finish: Phosphate treated and shop painted with the manufacturer's standard rust inhibitive primer.
- 2.4 ACCESSORIES
    - A. Anchorage Devices:
      - 1. Devices of the type required to secure units to the abutting structure.
- 2.5 SCHEDULE
    - A. General: Where not otherwise indicated, provide access doors in accordance with the following:
      - 1. Size: As required to comfortably achieve the purpose for which access is required.
      - 2. Types:
        - a. Flush: In non-public areas that are not restrooms, conference rooms or offices.
        - b. Recessed: In all public areas, restrooms, conference rooms and offices.
        - c. Universal: In exposed concrete and masonry surfaces.
- PART 3 EXECUTION
    - 3.1 EXAMINATION
      - A. Section 01700 - Execution Requirements: Verification of existing conditions before starting the work.
 

ACCESS DOORS AND PANELS                      08310-5
- B. Verification of Conditions: Verify that field measurements, surfaces, substrates and conditions are as required, and ready to receive the work.
    - 1. Verify that rough openings for the units are correctly located and properly sized. Report, in writing, prevailing conditions that will adversely affect satisfactory execution of the work of this Section. Do not proceed with the work until the unsatisfactory conditions have been corrected.
  - C.
    - 1. Verify that rough openings for the units are correctly located and properly sized. Report, in writing, prevailing conditions that will adversely affect satisfactory execution of the work of this Section. Do not proceed with the work until the unsatisfactory conditions have been corrected.
- 3.2 INSTALLATION
    - A. Install units in accordance with the manufacturer's published instructions, where indicated on Drawings, and where required for access.
    - B. Coordinate with mechanical, plumbing and electrical trades and other work requiring access.
    - C. Position units to provide convenient access to concealed work requiring access.
    - D. Set frames in position accurately and securely attached to supports with face panels plumb and level in relation to the adjacent finish surfaces.
    - E. Field paint surfaces exposed to view. See Section 09900 - Painting.
    - F. Built-in anchors and grouting of frames in concrete and masonry is included in Sections of Divisions 3 and 4.
  - 3.3 PROTECTION
    - A. Institute and maintain protective measures and take other precautions necessary to ensure that all assemblies will be without damage and deterioration at the time of final acceptance.
  - 3.4 ADJUSTING
    - A. Section 01700 - Execution Requirements: Adjusting the installed work.
    - B. Adjust hardware and panels after installation for proper operation.
    - C. Remove and replace panels and frames that are warped, bowed, twisted or otherwise damaged.
- 3.5 FIELD QUALITY CONTROL
    - A. Section 01450 - Quality Control: Field inspection.
    - B. Inspect installed units for location, alignment, plumb, level, attachment to framing, and operation.
- 3.6 CLEANING
    - A. Section 01700 - Execution Requirements: Cleaning the installed work.
    - B. Clean the units before final acceptance inspection.
 

ACCESS DOORS AND PANELS                      08310-6

END OF SECTION

SECTION 08400

ENTRANCES, STOREFRONTS, DOORS AND WINDOWS

PART 1 GENERAL

1.1 SUMMARY

A. Section Includes:

1. Aluminum exterior and interior entrances.
2. Aluminum storefronts.
3. Aluminum sidelites.
4. Aluminum flush doors.
5. Aluminum sliding doors.
6. Tempered glass doors.
7. Aluminum windows, fixed and operable.
8. Glass and glazing in-fill and vision panels.
9. Door hardware.
10. Window hardware.
11. Perimeter sealants.

B. Related Documents: The Contract Documents, as defined in Section 01010 - Summary of Work, apply to the work of this Section. Additional requirements and information necessary to complete the work of this Section may be found in other Documents.

C. Related Sections:

1. Section 03300 - Cast-in-Place Concrete: Substrate for anchorage.
2. Section 04230 - Reinforced Unit Masonry: Substrate for anchorage.
3. Section 07900 - Joint Sealers: Sealants for a weatherproof installation.
4. Section 08710 - Door Hardware: Hardware not specified in this Section.
5. Section 08800 - Glass and Glazing: Glazing for entrances, storefronts, sidelites, doors and windows including those specified herein to be factory-glazed.
6. Section 09110 - Non-Load Bearing Steel Framing: Non-structural framing for adjacent wall and ceiling finishes.
7. Section 09250 - Gypsum Board: Adjacent wall and ceiling finish material.
8. Section 09900 - Painting: Field painting of components.

ENTRANCES, STOREFRONTS,  
DOORS AND WINDOWS

08400-1

08310-7

ACCESS DOORS AND PANELS

1.2 DESCRIPTION OF WORK

- A. The extent of the work of this Section is indicated on the Drawings and Schedules and as specified herein, and includes providing and installing aluminum exterior and interior doors, entrances, storefronts, sidelites, flush doors, tempered glass doors, sliding doors and operable and fixed windows; tubular aluminum sections, shop-fabricated, factory-finished; glass and glazing in-fill; related flashings; anchorage and attachment devices; hardware; sealants.
- B. Provide complete operating door assemblies including door curtains, guides, hardware, operators, motors, and installation accessories. Coordinate with other hardware requirements in Section 08700.
- C. The systems are standard units to the shapes indicated, combined with extruded sections to create the profiles indicated.
- D. Provide assemblies that have been designed and fabricated to comply with requirements of the system performance characteristics below, as demonstrated by testing the manufacturer's corresponding stock systems in accordance with the test methods designated.
- E. Preparation of openings, structural support, access panels, finish and trim for openings, construction of storage pockets and painting shall be furnished and installed under other Sections herein.

1.3

REFERENCES

- A. The publications listed below form a part of this Specification to the extent referenced. Publications are referred to in the text by basic designation only.
- B. Aluminum Association (AA):
  - 1. AA DAF45 - Designation System for Aluminum Finishes.
- C. American Architectural Manufacturers Association (AAMA):
  - 1. AAMA 101 - Specification for Windows, Doors and Skylights.
  - 2. AAMA 501.1 - Methods of Test for Exterior Walls.
  - 3. AAMA 605.2 - Specification for High Performance Organic Coating on Architectural Extrusions and Panels.
  - 4. AAMA 607.1 - Specifications and Inspection Methods for Clear Anodic Finishes for Architectural Aluminum.
  - 5. AAMA 608.1 - Specification and Inspection Methods for Electrolytically Deposited Color Anodic Finishes for Architectural Aluminum.
  - 6. AAMA 611 - Specification for Anodized Architectural Aluminum.
  - 7. AAMA 701.2 - Specifications for Pile Weatherstripping and Replaceable Fenestration Weatherseals.
  - 8. AAMA 1503.1 - Test Method for Condensation Resistance of Windows.

ENTRANCES, STOREFRONTS,  
DOORS AND WINDOWS 08400-2

- 9. Manual #10 - Care and Handling of Architectural Aluminum From Shop to Site.
- 10. SFM-1-87 - Aluminum Storefront and Entrance Manual- AAMA Technical Reference Manual - Volume III.
- D. American National Standards Institute (ANSI):
  - 1. ANSI A 117.1 - Safety Standards for the Handicapped.
  - 2. A156.4 - Door Controls - Closers.
  - 3. ANSI A 156.5 - Standard for Auxiliary Locks and Associated Products.
  - 4. ANSI Z97.1 - Safety Glazing Materials Used in Buildings - Methods of Test.
- E. American Society of Civil Engineers (ASCE):
  - 1. ASCE / SEI 7 - Minimum Design Loads for Buildings and Other Structures.
- F. American Society for Testing and Materials (ASTM):
  - 1. ASTM A 36 / A 36M - Specification for Carbon Structural Steel.
  - 2. ASTM B 209 - Specification for Aluminum and Aluminum-Alloy Sheet and Plate.
  - 3. ASTM B 221 - Specification for Aluminum and Aluminum-Alloy Extended Bars, Rods, Wire, Profiles, and Tubes.
  - 4. ASTM B 308 / B 308M - Specification for Aluminum-Alloy 6061-T6 Standard Structural Profiles.
  - 5. ASTM E 283 - Test Method for Determining the Rate of Air Leakage Through Exterior Windows, Curtain Walls, and Doors Under Specified Pressure Difference Across the Specimen.
  - 6. ASTM E 330 - Test Method for Structural Performance of Exterior Windows, Doors, Skylights and Curtain Walls by Uniform Static Air Pressure Difference.
  - 7. ASTM E 331 - Test Method for Water Penetration of Exterior Windows, Skylight, Doors, and Curtain Walls by Uniform Static Pressure Difference.
  - 8. ASTM E 547 - Test Method for Water Penetration of Exterior Window, Skylights, Doors, and Curtain Walls by Cyclic Static Air Pressure Difference.
  - 9. ASTM E 1996 - Specification for Performance of Exterior Windows, Curtain Walls, Doors, and Impact Protective Systems Impacted by Windborne Debris in Hurricanes.
  - 10. ASTM F 588 - Test Methods for Measuring the Forced Entry Resistance of Window Assemblies, Excluding Glazing Impact.
  - 11. ASTM F 842 - Test Methods for Measuring the Forced Entry Resistance of Sliding Door Assemblies, Excluding Glazing Impact.
- G. Americans with Disabilities Act Accessibility Guidelines (ADAAG).

ENTRANCES, STOREFRONTS,  
DOORS AND WINDOWS 08400-3

- H. American Welding Society (AWS):
1. AWS A5.10 / A5.10M - Specification for Bare Aluminum and Aluminum-Alloy Welding Electrodes and Rods.
  2. AWS D1.1 / D1.1M - Structural Welding Code - Steel.
- I. Code of Federal Regulations:
1. 16 CFR 1201 - Safety Standards for Architectural Glazing Materials.
- J. Glass Association of North America:
1. Glazing Manual.
- K. International Code Council:
1. International Building Code (IBC), 2009.
- L. International Organization for Standards (ISO):
1. ISO 9001 - Quality Management Systems.
- M. National Association of Architectural Metal Manufacturers (NAAMM):
1. Metal Finishes Manual for Architectural and Metal Products.
- N. SSPC: Society for Protective Coatings (formerly Structural Steel Painting Council):
1. Paint 12 - Cold-Applied Asphalt Mastic (Extra Thick Film).

#### 1.4 PERFORMANCE TESTING

- A. General:
1. Perform tests on complete assembly mock-ups. Comply with the requirements indicated below. Perform tests prior to the start of fabrication.
  2. Where the manufacturer's standard system complies with the requirements, and has been tested in accordance with the specified tests, provide certification by the manufacturer showing compliance with such tests.
- B. Air Infiltration: Air infiltration rate shall not exceed 0.15 cfm / sq. ft. and 0.37 cfm / ft. of crack length when tested at a static air pressure differential of 6.24 pst when tested per ASTM E 283.
- C. Static Water Resistance: Specimen shall be subjected to a static pressure of 10.0 psf with a water spray application rate of 5 gph / sq. ft. for a duration of 15 minutes. No uncontrolled leakage is allowed. Tested per ASTM E 331.
- D. Seismic Performance at Design Displacement:
1. For buildings 4-stories and higher.
  2. The middle row of the anchors shall be shifted parallel to the plane of the wall for

ENTRANCES, STOREFRONTS,  
DOORS AND WINDOWS 08400-4

- distance of 0.75" in one direction, held for 10 seconds, then back to center, then the other direction 0.75", held for 10 seconds, then back to center. Visual observations shall be made at 1/4" displacements in both directions.
3. The test shall be repeated two additional times with no failure or gross permanent distortion of the anchors, frames or glass. Glazing gaskets may not disengage and weather seals shall not fail.
- E. Cyclic Water Resistance: Sliding doors shall be subjected to four (4) test cycles, with each cycle consisting of a static pressure of 12.0 psf with a water spray application of 5 gph / ft for a duration of 5 minutes each, and a 1 minute duration with pressure released but water application continuously applied. No uncontrolled leakage is allowed. Tested per ASTM E 547.
- F. Forced Entry Resistance: ASTM F 588 or ASTM F 842, performance level 10.
- G. Uniform Load: No deflection in excess of L / 175 of the span of any framing member at a structural test load equal to 1.5 times the specified design windload; no glass breakage or permanent set in the framing members in excess of 0.2% of their clear spans with a static air design load of 20 psf applied in the positive and negative directions in accordance with ASTM E 330.
- H. Component Structural Tests: Perform operating, hardware, sash rail rigidity and other tests called for by AAMA Voluntary Guide Specification for Aluminum Architectural Windows".

#### 1.5 SUBMITTALS

- A. Section 01330 - Submittal Procedures: Procedures for submittals.
1. Product Data: Manufacturer's technical product data, specifications, standard details, and installation recommendations for the components required. Provide component dimensions; describe components within the assembly, anchorage and fasteners, glass and glazing in-fill, hardware, and internal drainage details.
  2. Shop Drawings: Drawings for fabrication and installation of the required systems; indicate the system dimensions, framed opening requirements, tolerances, and affected related work; include plans, elevations, detailed sections of typical composite members, hardware mounting heights, reinforcement, and expansion and contraction joint locations. Show anchors, hardware and other components not included in the manufacturer's Product Data; include glazing details.
  3. Samples:
    - a. Aluminum Extrusions: Two (2) samples of each required aluminum finish on 12" long sections of the extrusion shapes required for the system.
    - b. The Architect reserves the right to require additional samples which show fabrication techniques, workmanship of component parts, design of the hardware and other exposed auxiliary items.
    - c. Glazing: Submit samples per Section 08800 - Glass and Glazing.
  4. Assurance / Control Submittals:
    - a. Manufacturer's certification or test reports certifying that the products have been tested and comply with the performance testing requirements.

ENTRANCES, STOREFRONTS,  
DOORS AND WINDOWS 08400-5

- b. Calculations indicating that the system and anchorages meet the Performance Requirements and the Building Code indicate anchor spacing. Indicate the number and placement of weld-in anchors and supplemental steel jamb and frame reinforcing, as necessary.
  - c. Certification that the door system meets the performance design criteria in accordance with the following:
    - i. ANSIA 156.10.
    - ii. NFPA 101.
    - iii. UL 325.
    - iv. IBC - 2009.
  - d. Documentation of experience indicating compliance with the specified qualifications requirements.
  - f. Manufacturer's Operation and Maintenance Data..
- B. Section 01780 - Closeout Submittals: Procedures for closeout submittals.
- 1. Manufacturer's Operation and Maintenance Manual.
  - 2. Warranty: Submit a written special Warranty with forms completed in the name of the Owner and registered with the manufacturer.

1.6 COORDINATION

- A. Pre-Installation Meeting: Convene a Pre-Installation Meeting at the Project Site prior to beginning the work of this Section.
- 1. Require attendance of the Contractor, Owner's representative, Architect, and representative of the Installer.
  - 2. Review the coordination required for proper installation.
  - 3. Review preparation and installation procedures, and the coordination and scheduling required with other related work.
- B. Check Shop drawings for other work to confirm that adequate provisions are made for locating and installing doors in compliance with the requirements.

1.7 QUALITY ASSURANCE

- A. Qualifications:
- 1. Manufacturer:
    - a. Company specializing in manufacturing the products specified with a minimum of five (5) years documented experience.
    - b. Company capable of providing field service representation during installation, approving an acceptable installer, and approving the

ENTRANCES, STOREFRONTS,  
DOORS AND WINDOWS 08400-6

installation.

- 2. Installer:
  - a. Company experienced in performing the work of this Section with a minimum of five (5) years documented experience.
  - b. Company with supervisory staff trained and approved by the door manufacturer and with the trained supervisory personnel observing and directing the work.
  - c. Company capable of providing field service after installation.

B. Performance Requirements:

- 1. Provide assemblies capable of withstanding the wind loads and thermal movements based on testing of the manufacturer's standard units in assemblies similar to those indicated for this Project.
- 2. Provide the capacity to withstand the following wind loading requirements:
  - a. Design, fabricate and install to resist combined positive and negative windloading in accordance with ASCE 7, Chapter 6 with a Vmph of 170, qs of 74.0 psf, exposure C and Importance Factor of 1.0.
- 3. Thermal Movement:
  - a. Provide for thermal movement resulting from the following maximum change in ambient and surface temperatures to prevent buckling, opening of joints, over stressing of components, failure of joint sealants, failure of connections, and other detrimental effects. Base engineering calculations on surface temperatures of the materials due to both solar heat gain and nighttime heat loss.
    - i. Ambient temperature range: 120E: F.
    - ii. Materials surface: 180E: F.

C. Furnish complete units produced by a single manufacturer, including hardware, accessories, tracks, mountings, and installation components.

D. Unless otherwise acceptable to the Architect, furnish all units and assemblies for the entire Project by one manufacturer.

E. Design Criteria: The Drawings are based on Kawneer's standard aluminum entrance, storefront, sidelite, sliding door and operable and fixed window systems. Other manufacturer's standard system of similar and equivalent nature may be acceptable when the difference does not materially detract from the design concept or required performance, as judged solely the Architect. The plans, elevations and details show the spacing of members as well as profiles and similar dimensional requirements, and the entrance, storefront, sidelights, and door and windows work.

1.8 DELIVERY, STORAGE AND HANDLING

A. Section 01600 - Product Requirements: Transport, handle, store, and protect the products.

ENTRANCES, STOREFRONTS,  
DOORS AND WINDOWS 08400-7

- 1.9 WARRANTY
- B. Protect finished aluminum surfaces with a strippable coating. Do not use adhesive papers or sprayed coatings which bond when exposed to sunlight or weather.
  - C. Pack, box, ship, unload, store and protect products in a manner to avoid breakage, abuse, damage and defacement.
  - D. Deliver products to the Project Site in the manufacturer's original, unopened protective packaging.
  - E. Store inside, protected from weather.
  - F. Stack vertically on edge to provide for water drainage and air circulation.
  - G. Break seals to permit ventilation.
- 2.1 MANUFACTURERS
- A. Subject to compliance with the Project requirements, manufacturers offering products which may be incorporated into the work include the following:
    - 1. Kawneer Company, Inc. components are referenced within this Section to establish the level of quality required.
    - 2. Alternate Manufacturers: Subject to compliance with the Project requirements, alternate manufacturers offering the specified items which may be incorporated in the work include the following:
      - a. Bradham Aluminum Corp.
      - b. Century Manufacturing.
      - c. United States Aluminum.
      - d. Oldcastle Glass Engineered Products.
- 2.2 PRODUCTS
- B. Section 01600 - Product Requirements: Product Options: Substitutions permitted.

ENTRANCES, STOREFRONTS,  
DOORS AND WINDOWS

08400-8

2.2 MATERIALS AND ACCESSORIES

- A. Aluminum Members: Alloy and temper as recommended by the manufacturer for strength, corrosion resistance, and application of the required finish; ASTM B 221 for extrusions, ASTM B 209 for sheets and plates.
- B. Steel Sections: ASTM A 36 / A 36M; shaped to suit the mullion sections.
- C. Reinforcement: Where fasteners screw-anchor into aluminum less than 0.125" thick, reinforce the interior with aluminum or non-magnetic stainless steel to receive the screw threads, or provide standard non-corrosive pressed-in splined grommet nuts.
- D. Brackets and Reinforcements: Manufacturer's high-strength aluminum units where feasible, otherwise, non-magnetic stainless steel. Steel reinforcing shapes to be stainless steel or hot-dip galvanized steel complying with ASTM A 123 / A 123M.
- E. Concealed Flashings: Dead-soft stainless steel, 26-gauge minimum, or extruded aluminum, 0.062" minimum, of an alloy and type selected by the manufacturer for compatibility with other components.
- F. Anchors: Drill-in expansion bolts or weld-in type with in-place steel anchors welded to steel plates anchoring the frame.
- G. Fasteners:
  - 1. Aluminum, non-magnetic stainless steel, or other materials warranted by the manufacturer to be non-corrosive, and compatible with aluminum components.
  - 2. Do not use exposed fasteners for the attachment of hardware, except where unavoidable and where clearly noted on submittal shop drawings.
  - 3. Provide Phillips flat-head machine screws for exposed fasteners. Finish shall match the finish of the adjoining metal.
- H. Glass and Glazing Materials: Provide glass and glazing materials which comply with the requirement of Section 08800 - Glass and Glazing, including for doors and windows specified to be factory-glazed.
- I. Weatherstripping: Provide compression-type weatherstripping at the perimeter of each operating sash; manufacturer's standard replaceable stripping of either molded neoprene gaskets complying with ASTM D 2000, or molded PVC gaskets complying with ASTM D 2287, or molded neoprene gaskets complying with ASTM C 509, Grade 4.
- J. Sealant and Backing Materials: Unless otherwise indicated for sealants required within fabricated window units, provide a type recommended by the product manufacturer for the joint size and movement, to remain permanently elastic, non-shrinking and non-migrating. Comply with Section 07900 - Joint Sealers, for installation of sealants and backing materials.

2.3 FABRICATION

- A. Sizes and Profiles: The sizes for units, including profile requirements, shall be as indicated and as required to meet the Performance Requirements. Any variable dimensions are indicated, together with maximum and minimum dimensions required to achieve the design requirements and coordination with other work.

ENTRANCES, STOREFRONTS,  
DOORS AND WINDOWS

08400-9

- B. Field Measurement: Wherever possible take field measurements prior to the preparation of Shop Drawings and fabrication to ensure proper fitting of the work. Proceed with fabrication and coordination, as necessary, when the taking of field measurements might delay the work.
- C. Prefabrication: To the greatest extent possible, complete fabrication, assembly, finishing, hardware application, and other work before shipment to the Project Site. Disassemble components only as necessary for shipping and installation.
1. Pre-glaze door and window units to the greatest extent possible, in coordination with the installation and hardware requirements.
  2. Do not drill and tap for surface-mounted hardware items until the time of installation at the Project Site.
  3. Perform fabrication operations, including cutting, fitting, forming, drilling and grinding of metal work in a manner to prevent damage to exposed finish surfaces. For hardware, perform these operations prior to the application of finishes.
  4. Fabricate framing for glazing from the inside, except for large plates of glass which may be glazed from the outside.
- D. Glazing: Provide for the following edge clearances:
- | <u>Single Glazed</u>           |       |
|--------------------------------|-------|
| Nominal edge cover (bite)      | 5/16" |
| Minimum nominal edge clearance | 1/8"  |
| Minimum face clearance         | 1/8"  |
1. Glass must be edge blocked to prevent contact with the metal framing.
- E. Reinforcing: Install reinforcing, as necessary, to meet the Performance Requirements.
- F. Welding: Comply with AWS recommendation to avoid discoloration; grind exposed welds smooth and restore mechanical finish.
- G. Continuity: Maintain accurate relationship of planes and angles, with hairline fit at contacting members.
- H. Fasteners: Conceal fasteners wherever possible.
- I. Weatherstripping: For exterior doors and windows, provide compression weatherstripping against fixed stops, at other edges provide sliding weatherstripping retained in adjustable strip mortised into door edges.
- J. Structural Silicon Sealant: As recommended by the manufacturer.

#### 2.4 ALUMINUM ENTRANCES

- A. Doors: Standard Aluminum Entrance, Series [350 Medium Stile] [500 Wide Stile] swing door by Kawneer. Size as indicated on the Drawings.
1. Vertical Stile: [3-1/2"] [5"], single piece.
  2. Top Rail: [3-1/2"] [5"], single piece.

ENTRANCES, STOREFRONTS,  
DOORS AND WINDOWS

08400-10

3. Bottom Rail: 6-1/2", single piece.
- B. Door Hardware:
1. Section 01310 - Project Management and Coordination: Verification of hardware components specified in Section 08710 - Door Hardware.
  2. Door Hinges: Door manufacturer's standard butt hinges, US32D finish.
  3. Offset Pivots: Where indicated provide top, intermediate and bottom offset pivots; assemblies complying with ANSI A 156.4, Grade 1 requirements; cast aluminum-alloy, baked epoxy finish to match the door finish; door manufacturer's standard.

4. Concealed Overhead Closers: Single-acting manual, with built-in door stop, 105% hold open; door manufacturer's standard, ADAAG compliant.
  - a. Force for pushing or pulling open interior doors shall not exceed 5-pounds.
  - b. For push button operated openers see 08710.
5. Push / Pulls and Panic Hardware: Standard to the door manufacturer, directly mounted on the glass.
  - a. CP-II Push and CO-9 Pull by Kawneer. Finish to match door. Use where an exit device and / or exterior trim is not specified.
6. Deadlocks: Three-point locks, located in the bottom rail.
7. Door Locking Devices (where noted in Section 08710): Adams Rite MS+1890 deadbolt / latch, double cylinder operation. Finish: 628.
8. Exit Devices: Concealed vertical rods with crash bar doggable; exterior mortise trim. Clear #17 finish for exterior / exit doors.
  - a. Latch shall release when subject to a 15-pound force.
9. Three-point Lock: #4015 foot bolt and #4085 head bolt by Adams Rite.
10. Flush Bolt: Top and bottom flush; surface-mounted in the nose of the door stile.
11. Automatic Door Bottoms: 3/4" mortise type; Pemko #420 AVL.
12. Floor-Mounted Holder: Rubber cushioned stop with door-mounted holder; door manufacturer's standard.
13. Weatherstripping (Exterior doors only): As selected from the manufacturer's standards.
  - a. Head and Jamb: Replaceable wool, polypropylene, or nylon wool pile with aluminum strip backing, recessed in the frame; AAMA 701.2.
  - b. Sill: Semi-rigid polymeric material on aluminum anodized to match the door; EPDM sweep strip, 38-560 by Kawneer.

ENTRANCES, STOREFRONTS,  
DOORS AND WINDOWS

08400-



- A. Glass doors and framing system; factory-glazed with 1/2" thick tempered glass, minimum, or as required to meet the Performance Requirements.
- B. Glass: Brite Vue glass by Oldcastle Glass Co.
- C. Hardware: As provided by the door manufacturer.

- 1. Push / Pulls: Manufacturer's standard, as selected.

2.8 ALUMINUM WINDOWS AND SLIDING DOORS

- A. General: The drawings and following paragraphs define the operating arrangement for the types of sash (ventilators) required in the window units, and specify the minimum provisions for each type. The Drawings indicate which panels of each window unit are operable sash and which are fixed. Where two or more types of operating sash are included in the same window unit, the operation of each is indicated, and the unit is considered a "Combination Window".

Provide the following:

- 1. High rise sill with subsill sill pan at each sliding door and window.
- 2. Swing limiters set at 4" at all operating sashes.
- 3. Insect screens with maximum opening at the lock side of the operating sashes unless indicated otherwise.

- B. Fixed Window Units: All joints of frames shall be butt type construction, neatly secured at each corner with integral screw ports; 3-1/8" main frame depth, 0.078" nominal wall thickness. Commercial line 7225 Non-Thermal, HC90 by Kawneer.
- C. Casement Window Units: Out-swinging, interior glazed. 7225 Non-Thermal, HC90 by Kawneer.

- D. Projecting Window Units: Out-swinging, top-hinged, unless otherwise noted, 2-1/4" frame depth; horizontal pivoting with extruded 360 degree aluminum pivots; concealed limit stop and removable key handle lock at each vent; interior glazed. 7225 Non-Thermal, HC90 by Kawneer.

- E. Horizontal Sliding Window Units: Commercial high performance quality, stainless steel roller assemblies, locks and keepers, two-piece compensating head detail; 4" frame depth with interior insect screens; interior glazed. Series 7330 by Kawneer.

- F. Vertical Sliding Units: Commercial high performance quality, stainless steel roller assemblies, two factory-installed sash balances for each operating sash, locks and keepers, two-piece compensating head detail, 4" frame depth with interior insect screen; interior glazed. Series 7330 by Kawneer.

- G. Sliding Aluminum and Glass Doors: Two-piece compensating channel subheads and jamps; heavy-duty interlocks and horizontal muntins, factory-glazed. HPS High Performance Sliding [60] [80] [100] [120] by Kawneer.

Hardware:

- 1. Locking handles, cases, keepers, catches and fasteners shall be of a corrosion-resistant material compatible with aluminum.

ENTRANCES, STOREFRONTS,  
DOORS AND WINDOWS 08400-

- 14. Thresholds: Weatherproof, 4" or 6", as detailed, mill-finished aluminum, standard for offset pivots; cut as required for carpet or tile adaptation as detailed. ADAAG compliant.

- 15. Other Hardware: As described in the door manufacturer's literature, as specified or as required.

- 16. Section 01600 - Product Requirements: Product Options: Substitutions permitted.

2.5 ALUMINUM STOREFRONTS

- A. Provide a system combined with extruded aluminum sections, to the profiles indicated; designed to meet the Performance Requirements.

- B. Storefront Framing System: Trifab Versa Glaze 451 / 451T by Kawneer, 2" x dimension shown, extruded aluminum; minimum wall thickness of 0.080"; flush glazed.

- C. Column Covers: 0.040" aluminum by Kawneer. Finish to match the storefront system.

- D. Receptor Channel: Model No. 450-038 and 65-025 by Kawneer; finish to match the storefront system.

- E. Provide aluminum entrances fabricated to comply with the elevations and details shown on the Drawings.

2.6 ALUMINUM FLUSH DOORS

- A. Doors: Kawneer Standard Flushline Series.

- 1. Face Sheets: 0.062" embossed aluminum.

- 2. Core: 3 lb. / cu. ft. density, foamed-in-place polyurethane, 1/8" thick tempered hardboard backing at each face, bonded to the core.

- 3. Reinforcement: Internally for the installation of hardware.

- 4. Trim: Beveled edge aluminum extrusion around the entire door perimeter and the perimeter of glass and louver openings to receive the skin and hardboard.

- 5. Weatherstripping: Woodpile around the entire door perimeter.

- 6. Vision lites and Louvers: As indicated on the Drawings.

Hardware:

- 1. See Section 08710 - Door Hardware.

- 2. Supplemental Flush Door Storm Hardware: Provide intermediate barrel bolts at 30" o.c. to latch doors greater than 7'-0" in height, and at the center of door heads and sills to secure doors greater than 42" in width.

- C. Frames: Trifab VG (Versa Glaze) 450 by Kawneer.

2.7 TEMPERED GLASS DOORS

ENTRANCES, STOREFRONTS,  
DOORS AND WINDOWS 08400-12

2. Hardware shall meet AAMA tests and be suitable for its intended use.
- 2.9 GLASS AND GLAZING MATERIALS
- A. Glazing: As specified in Section 08800 - Glass and Glazing.
- B. Double wet glaze with Dow 995, or approved equal.
- 2.10 SEALANT
- A. Sealant and Backing Materials:
1. Perimeter Sealant: Type as specified in Section 07900 - Joint Sealers.
  2. Sealant Used Within the System (Not for Glazing): Type as specified in Section 07900 - Joint Sealers.
- 2.11 HARDWARE
- A. General: Provide the manufacturer's standard heavy-duty hardware units, as indicated, scheduled, or as required for the operation of each door and window, as recommended by the manufacturer for the service required; finish to match the frame unless otherwise indicated.
- 2.12 FINISHES
- A. Exposed Aluminum Surfaces:
1. Clear anodized or as selected from the manufacturer's standard finishes.
  2. Polyvinylidene fluoride, (Kynar) or equal as selected from manufacturer's standard colors.
- B. Maintain same color range on doors, frames and other components. Do not mix light and dark shades within an assembly.
- PART 3 EXECUTION
- 3.1 EXAMINATION
- A. Section 01700 - Execution Requirements: Verification of existing conditions before starting the work.
- B. Verification of Conditions: Verify that field measurements, surfaces, substrates and conditions are as required, and ready to receive the work.
1. Verify that related work performed under other Sections has been completed, and is in accordance with approved Shop Drawings.
  2. Verify that openings are dimensionally within allowable tolerances; plumb, level, clean and provide for proper anchoring.
- C. Report in writing, prevailing conditions that will adversely affect satisfactory execution of the work of this Section. Do not proceed with the work until the unsatisfactory conditions

ENTRANCES, STOREFRONTS,  
DOORS AND WINDOWS 08400-14

- have been corrected.
- 3.2 INSTALLATION
- A. Install doors and windows, complete, with all necessary hardware, jamb and head mold strips, anchors, inserts, hangers, and equipment supports in accordance with approved Shop Drawings, manufacturer's instructions, to meet the Performance Requirements, and as specified herein.
  - B. Attach to the structure to permit sufficient adjustment to accommodate construction tolerances and other irregularities.
  - C. Anchor and weld securely in place; provide alignment attachments and shims to permanently fasten systems and units to the building structure. Anchorages shall be concealed.
  - D. Comply with AWS recommendation to avoid discoloration; grind exposed welds smooth and restore the mechanical finish.
  - E. Align assemblies and units plumb, level and true to line, without warp or rack of framing members, doors, windows and panels. Maintain assembly dimensional tolerances; align with adjacent work.
  - F. Install sill flashings with turned up edges and ends; seal to adjacent work to form a water tight dam.
  - G. Install compensating channels at door and window heads where indicated.
  - H. Ensure water drainage away from glazing.
  - I. Coordinate the attachment and seal of perimeter air and vapor barrier materials.
  - J. Provide thermal isolation where components penetrate or disrupt the building insulation. Pack fibrous insulation in shim spaces at the perimeter of assemblies and units to maintain continuity of the thermal barrier.
  - K. Install hardware using templates provided, and in accordance with the installation requirements in Section 08710 - Door Hardware.
  - L. Drill and tap frames, doors and windows and apply surface-mounted hardware items in compliance with the hardware manufacturer's instructions and templates. Use concealed fasteners wherever possible.
  - M. Set sill members, thresholds and other members in a bed of sealant, as indicated, or with joint fillers or gaskets, as indicated, to provide a weathertight installation. Coordinate the installation with wall flashings and other components of the work. Comply with the requirements of Section 07900 - Joint Sealers.
  - N. Apply sealants to provide a watertight installation at all joints and intersections and at all opening perimeters. Install perimeter sealants and backing materials in accordance with the installation requirements of Section 07900 - Joint Sealers.
  - O. Set thresholds in a bed of mastic, and secure.
  - P. Refer to Section 08800 - Glass and Glazing for the installation of glass and other panels shown to be glazed into doors, windows and framing, and not pre-glazed by the

ENTRANCES, STOREFRONTS,  
DOORS AND WINDOWS 08400-

manufacturer.

- Q. Separate aluminum and other corrodible metal surfaces from sources of corrosion and electrolytic action at points of contact with other metals. Isolation Requirements:
1. Dissimilar Metals: Where aluminum surfaces are in contact with, or fastened to dissimilar metals except stainless steel, zinc or zinc coating, protect aluminum from the dissimilar metal. Where aluminum contacts another metal, paint the dissimilar metal with epoxy paint. Where drainage from a dissimilar metal passes over aluminum, paint the dissimilar metal with a non-lead pigmented paint.
  2. Cementitious Materials: Paint aluminum where in contact with mortar, concrete or other cementitious material, with an alkali-resistant coating such as heavy-bodied bituminous paint or epoxy paint.
  3. Wood Contact: Isolate aluminum from cedar, redwood, oak and acid-treated lumber by means of unbroken 6-mil polyethylene construction sheet or a heavy coating of metal-protective paint.
  4. Surfaces in contact with sealants after installation shall not be coated with any type of protective material.

### 3.3 ADJUSTING

- A. Section 01700 - Execution Requirements: Adjusting installed work.
- B. Adjust operating hardware to function properly, without binding, and to prevent tight fit at contact points and weatherstripping.
- C. Doors operation shall meet ADAAG requirements for opening force.
- D. Repair damaged finishes to match the original finish.

### 3.4 FIELD QUALITY CONTROL

- A. Section 01450 - Quality Control: Field testing and inspection.
- B. Inspect installations for alignment, level, plumb, secure attachment to the structure, and smooth and proper operation.
- C. On-Site Tests:
1. If the units do not appear to meet air or water infiltration requirements, the Owner, may require on-site tests shall be conducted for both air and water infiltration, with the door manufacturer's representative present. The Owner's representative will select the unit(s) to be tested. If such unit(s) fail to meet the specified air and water requirements, the reason for failure shall be jointly determined.
  2. Tests shall be conducted in accordance with AAMA 101-88.
  3. The responsible Contractor shall correct tested units that do not meet the specified requirements, and all units with similar deficiencies, at no additional cost to the Owner.
  4. The cost for all successful tests, both original and retest shall be paid by the Owner. All unsuccessful tests, both original and retest, shall be paid for by the

ENTRANCES, STOREFRONTS,  
DOORS AND WINDOWS 08400-16

responsible Contractor.

5. The testing shall be done by an AAMA-accredited testing agency, selected by the Owner's representative and the manufacturer, and shall be employed by the responsible Contractor.

### 3.5 CLEANING

- A. Section 01700 - Execution Requirements: Cleaning the installed work.
- B. Remove protective material from pre-finished aluminum surfaces.
- C. Promptly after the installation of glass and sealants, clean the completed system, inside and out, exercise care to avoid damage to coatings and finishes.
- D. Remove excess glazing and joint sealants, dirt, and other substances from aluminum surfaces by a method acceptable to the sealant manufacturer.
- E. Wash down exposed surfaces with a solution of mild detergent in warm water, applied with soft, clean wiping cloths. Take care to remove dirt from corners. Wipe surfaces clean and dry.

### 3.6 PROTECTION

- A. Implement and maintain protective measures, and take other precautions necessary to ensure that all assemblies will be without damage and deterioration at the time of Substantial and Final Completion.

END OF SECTION

ENTRANCES, STOREFRONTS,  
DOORS AND WINDOWS 08400-

SECTION 08560

STORM PROTECTION

PART 1 GENERAL

1.1 SUMMARY

A. Section Includes:

1. Removable storm panels.
2. Accordion shutters.
3. Hinged aluminum shutters.

B. Related Documents: The Contract Documents, as defined in Section 01010 - Summary of Work, apply to the work of this Section. Additional requirements and information necessary to complete the work of this Section may be found in other Documents.

C. Related Sections:

1. Section 03300 - Cast-In-Place Concrete: Substrate for supporting storm protection.
2. Section 04230 - Reinforced Unit Masonry: Substrate for supporting storm protection.

1.2 DESCRIPTION OF WORK

- A. The extent of storm protection work is indicated on the Drawings and Schedules and as specified herein, and includes providing and installing products applied to exterior doors, windows, storefronts and open areas in buildings.
- B. Take field measurements prior to the preparation of Shop Drawings and fabrication of the protection units.

1.3 REFERENCES

- A. The publications listed below form a part of this Specification to the extent referenced. Publications are referred to in the text by basic designation only.
- B. American Society of Civil Engineers (ASCE):
  1. ASCE / SEI 7 - Minimum Design Loads for Buildings and Other Structures.
- C. American Society for Testing and Materials (ASTM):
  1. ASTM B 633 - Specification for Electrodeposited Coatings of Zinc on Iron and Steel.
  2. ASTM B 766 - Specification for Electrodeposited Coatings of Cadmium.
  3. ASTM E 330 - Test Method for Structural Performance of Windows, Doors, Skylights and Curtain Walls by Uniform Static Air Pressure Difference.

STORM PROTECTION 08560-1

D. International Code Council:

1. International Building Code (IBC), 2009.

1.4 SYSTEM PERFORMANCE

A. Provide storm protection units with materials and assemblies to conform to the Building Code, Wind Load requirements for storm panels / shutters for external application, except where more stringent requirements are indicated.

B. Performance Requirements:

1. Provide the capacity to withstand the following loading requirements:
  - a. Design and install to resist combined positive and negative windloading in accordance with IBC, 2009, Section 1609 with a  $V_{mph}$  of 170,  $q_s$  of 74.0 psf, exposure [B] [C] [D], and importance factor of [1.0] [1.25] [1.5], as applicable per ASCE 7.
2. Heights above ground level are indicated on or can be calculated from the Drawings.

1.5 SUBMITTALS

A. Section 01330 - Submittal Procedures: Procedures for submittals.

1. Product Data: Manufacturer's product literature and specifications describing the storm protection products, including color selections and finishes.
2. Shop Drawings: Show elevations of units, full size profiles of frame and track members; thickness of metal; sizes, types, materials, finishes, and location of fasteners; type, material and location of operating hardware, mullion details; and details of installation, including connection and relationship to other work.
  - a. Include a schedule showing the location of units for each size and type.
3. Samples: Submit two (2) each pieces of the assemblies, and the required finish on 6" long sections of typical frame members, plus a 12" x 12" sample of the panel itself.
4. Test Reports: Submit certified laboratory test reports evidencing that storm panels of the type indicated comply with the performance requirements.

PART 2 PRODUCTS

2.1 MANUFACTURERS

- A. Subject to compliance with the Project requirements, manufacturers offering products which may be incorporated into the work include the following:
  1. Seaview Shutters Inc., Miami, FL, (represented by AMS, Guam).

STORM PROTECTION 08560-2

2. Willard Shutter Company, Inc., Miami, FL (represented by KB Enterprises, Guam).  
 B. Section 01600 - Product Requirements: Product Options: Substitutions permitted.
- 2.2 MATERIALS
- A. Provide alloys complying with ANSI / AAMA 1002.10 and as recommended by the aluminum producer for the forming and fabricating process used by the manufacturer and for the type of finish required.
- B. Other Materials: Where metals other than aluminum are standard with the manufacturer for concealed reinforcing, concrete inserts, fasteners and hardware, use stainless steel or other non-corrosive materials which are compatible with aluminum. Electroplate steel, if used for reinforcing members, with zinc or cadmium coating complying, respectively, with ASTM B 633 or B 766. For exposed fasteners match the color and finish of the metal material being fastened.
- C. Non-Metallic Spacers: Provide the manufacturer's standard vinyl, rubber or high density polyurethane spacers, not less than 1/8" thick, to separate storm shutters from contact with metal prime windows.
- 2.3 REMOVABLE STORM PANELS
- A. Headers and Sills: Slip-in type, and made of extruded aluminum alloy 6063-T5.
- B. Structural Panels: Roll-formed from aluminum alloy 3003-H16, of a thickness to withstand the positive and negative forces applied on the spans required, but not less than 0.065". Panels shall be designed to allow nesting for storage with T&G edges for interlocking of erected panels at 12"o.c..
- C. Clips and Wing Nuts: Stainless steel, standard with the manufacturer.
- D. Reinforcing Tubes and Frames, Door Angel Frames and Stops: Sizes and shapes, and fabricated as detailed, extruded aluminum alloy 6063-T5.
- E. Aluminum Mill Finish: For panels, angles, tubes, embedded items, and removable base and head members.
- F. Anodized Finish: Match the finish of the adjacent windows for base and head members which are to remain permanently in-place.

2.4 ACCORDION SHUTTERS

- A. Headers and Sills: 0.125" thick extruded aluminum alloy 6063-T5.
- B. Shutters: Extruded aluminum blades of extruded aluminum alloy 6063-T5 with stainless steel carriage, nylon rollers and nylon guides; top and bottom locking rods with stainless steel thumb screws. Provide end closure pieces securely attached to the wall.
- C. Finish: All aluminum materials to be finish color as selected by the Architect from the manufacturer's standards.

2.5 HINGED ALUMINUM SHUTTERS

- A. Provide hinged aluminum shutters as indicated and detailed on the Drawings. Aluminum panel doors shall be custom fabricated for exterior use.

STORM PROTECTION 08560-3

- B. Provide two (2) recessed flush bolts at the top and two (2) flush bolts at the bottom for each panel, with dust proof floor strikes. Track shall be standard to the manufacturer.

PART 3 EXECUTION

3.1 EXAMINATION

- A. Section 01700 - Execution Requirements: Verification of existing conditions before starting the work.
- B. Verification of Conditions: Verify that field measurements, surfaces, substrates and conditions are as required, and ready to receive the work.
- C. Report, in writing, prevailing conditions that will adversely affect satisfactory execution of the work of this Section. Do not proceed with the work until the unsatisfactory conditions have been corrected.

3.2 INSTALLATION

- A. Comply with the manufacturer's instructions for the installation of storm shutters.
- B. Set storm units plumb, level and without distortion, securely fastened to, and aligned with the prime windows.
- C. Fasten to allow for expansion and contraction without damage to the window members or pullout of fasteners. Fasten members required to be in a fixed position, as detailed; for those that are required to be removable, verify the connectors and inserts, and fabricate accordingly.
- D. Position storm panels main frame so it does not contact the prime window frame, or install a non-metallic spacer between the prime window and the storm shutter and frame.
- E. Provide weepholes in sill tracks. Size the holes to effectively permit the drainage of rain water collecting between closed storm shutters and the windows they protect.
- F. Isolation Requirements:

1. Wood Contact: Isolate sheet metal from cedar, redwood, oak and acid-treated lumber by means of unbroken 6-mil polyethylene construction sheet or a heavy coating of metal-protective paint.
2. Dissimilar Metals: Insulate the juncture between dissimilar metals with a heavy coating of insulating film.
3. Concrete Contact: Coat the underside of sheet metal over horizontal concrete surfaces with an asphaltum cement.

3.3 FIELD QUALITY CONTROL

- A. Section 01450 - Quality Control: Field inspection.
- B. Inspect for plumb, level and secure attachment to substrates, where applicable.

3.4 ADJUSTING AND CLEANING

STORM PROTECTION 08560-4

- A. Section 01700 - Execution Requirements: Adjusting and Cleaning the installed work.
- B. Adjust inserts, and hardware to provide a tight fit at contact points, for smooth operation, and for a weathertight closure.
- C. Clean surfaces promptly after installation, exercising care to avoid damage to the finish of new and existing surfaces.

END OF SECTION

SECTION 08710  
DOOR HARDWARE

PART 1 GENERAL

1.1 SUMMARY

A. Section Includes:

1. Finish Hardware items required for swing, sliding and folding doors, except special types of unique and non-matching hardware specified in the same Section as the doors and windows.
2. Hinges.
3. Locks, latches and bolts.
4. Push / Pull units.
5. Exit devices. (Panic Hardware).
6. Closers.
7. Stops, holders and bumpers.
8. Thresholds.
9. Weatherstripping.
10. Miscellaneous hardware.

B. Related Documents: The Contract Documents, as defined in Section 01110 - Summary of Work, apply to the Work of this Section. Additional requirements and information necessary to complete the Work of this Section may be found in other Documents.

C. Related Sections:

1. Section 06100 - Rough Carpentry: Rough hardware.
2. Section 06100 - Rough Carpentry: Installation of finish hardware.
3. Section 06400 - Architectural Woodwork: Cabinet hardware.
4. Section 08100 - Hollow Metal Doors and Frames: Hardware for metal doors.
5. Section 08210 - Wood Doors: Hardware for wood doors.
6. Section 08420 - Aluminum Doors and Windows: Door and window hardware.
7. Section 12305 - Science Casework and Laboratory Equipment: Cabinet hardware.

1.2 DESCRIPTION OF WORK

- A. The extent of the finish hardware work is indicated on the Drawings and as specified herein, and includes furnishing and installing all finish hardware, trim, attachments and

STORM PROTECTION

08560-5

DOOR HARDWARE

08710-1

fastenings specified complete and proper. Under this Section include all hardware that is not specified in other Sections, whether or not such hardware is herein scheduled.

### 1.3 REFERENCES

- A. The publications listed below form a part of this Specification to the extent referenced. Publications are referred to in the text by basic designation only.
- B. American National Standards Institute (ANSI):
  - 1. ANSI A117.1 - Specifications for Making Buildings and Facilities Accessible to and Usable by Physically Handicapped People.
  - 1. ANSI A156.1 - National Standard for Butts and Hinges.
  - 2. ANSI A156.2 - National Standard for Locks and Lock Trim.
  - 3. ANSI A156.3 - National Standard for Exit Devices.
  - 5. ANSI A156.4 - National Standard for Closers.
  - 6. ANSI A156.5 - Standard for Auxiliary Locks and Associated Products.
  - 7. ANSI A156.6 - National Standard for Architectural Door Trim.
  - 8. ANSI A156.13 - National Standard for Mortise Locks & Latches.
  - 9. ANSI A156.16 - Standard for Auxiliary Hardware.
- C. American Society for Testing and Materials (ASTM):
  - 1. ASTM E 283 - Test Method for Determining Rate of Air Leakage Through Exterior Windows, Curtain Walls and Doors.
- D. Americans with Disabilities Act Accessibility Guidelines (ADAAG):
  - 1. Accessibility Guidelines for Buildings and Facilities.
- E. Door Hardware Institute (DHI):
  - 1. Recommended Locations for Architectural Hardware for Standard Steel Doors and Frames.
- F. National Fire Protection Association (NFPA):
  - 1. NFPA 80 - Standard for Fire Doors and Other Opening Protectives.
  - 2. NFPA 101 - Life Safety Code.
  - 3. NFPA 252 - Standard Methods for Fire Tests of Door Assemblies.
- G. Underwriters Laboratories (UL):
  - 1. UL 10B - Standard for Safety Fire Tests for Door Assemblies.
  - 2. UL 305 - Panic Hardware.

DOOR HARDWARE

08710-2

### 1.4 HARDWARE FOR FIRE DOORS AND EXIT DOORS

- A. Provide all hardware necessary to meet the requirements of NFPA No. 80 for fire doors and NFPA No. 101 for exit doors, as well as other requirements specified, even if such hardware is not specifically mentioned in the "Hardware Schedule". Such hardware shall bear a UL label.

### 1.5 SUBMITTALS

- A. Section 01330 - Submittal Procedures: Procedures for submittals.
  - 1. Product Data: Manufacturer's technical product data for each item of hardware. Include information necessary to show compliance with requirements, instructions for installation, and maintenance of operating parts and finishes.
  - 2. Hardware List: Prepare and submit three (3) copies of a Hardware List for review. One (1) copy will be returned. The List shall identify each hardware item by manufacturer, manufacturer's catalog number, and the exact location in the work. Indicate applicable scheduled door data, including the door numbers shown on the Drawings, the number of doors, hand of operation with an explanation of how the hand is determined, and indicate the active leaf where a pair of doors are required. Indicate hardware finishes.
    - a. Fastening Data: Indicate and clearly highlight "exposed on surface of hardware" fasteners, and through fastenings which would be exposed on the opposite door face when other than Phillips flat-head devices are proposed.
    - b. The Hardware List shall be in a suitable form to facilitate ready review by the Owner's representative. Acceptance of the List will not relieve the Hardware Supplier from the responsibility for furnishing the job complete.
  - 3. Catalog Cuts: Submit three (3) catalog cuts of every item to be furnished. One (1) copy will be returned. Show all finishes, sizes, catalog numbers and pictures, include information necessary to show compliance with the requirements, instructions for installation, and maintenance of operating parts and finishes. Explain all abbreviations fully.
  - 4. Mounting Locations: Submit mounting locations data for each type of hardware required.
  - 5. Hardware Schedule: Submit a Hardware Schedule as indicated below. Coordinate hardware with the doors, frames and related work to ensure proper size, thickness, backset, hand, function and finish.
    - a. Final Hardware Schedule Content: Based on the finish hardware indicated, organize a Hardware Schedule into "Hardware Sets", indicating a complete designation of every item required for each door. Provide the following information:
      - 1). Type, style, function, size and finish of each hardware item.
      - 2). Name and manufacturer of each item.
      - 3). Fastenings and other pertinent information.
      - 4). Location of the hardware set cross-referenced to the Drawings, both on the Floor Plans and Door Schedule.

DOOR HARDWARE

08710-3

- 5). Explanation of all abbreviations, symbols, codes, etc. contained in the Hardware Schedule.
- 6). Mounting locations for hardware.
- 7). Door and frame sizes and materials.
- 8). Keying and master keying information.
- b. Submittal Sequence: Submit the Hardware Schedule at the earliest possible date, particularly where acceptance of the Schedule must precede the fabrication of other work (e.g., aluminum frames) critical to maintaining the Project Construction Schedule. Include with the Schedule, product data, samples, Shop Drawings of other work affected by the finish hardware, and other information essential for a coordinated review of the Schedule. Acceptance of the Hardware List does not relieve the Hardware Supplier from the responsibility of furnishing the job complete for its intended purpose.

6. Keying Schedule: Submit with the final Hardware Schedule. Door designations to be the same as those on the Drawings.

7. Samples: Prior to submittal of the Final Hardware Schedule, and prior to ordering of the finish hardware, submit one (1) sample of each type of exposed hardware, as selected, with the required finish, including fasteners, and tagged with a full description for coordination with the Hardware Schedule.

a. Samples will be returned to the supplier. Units which are acceptable and remain undamaged through submittal, review and field comparison procedures may, after final check of the operation, be used in the work, within limitations of the keying coordination requirements.

B. Maintenance Related Items: Provide one (1) set of adjusting tools, two (2) sets of Maintenance Manuals, including lubrication requirements, parts list, manufacturers contact for ordering replacement parts and basic installation instructions for locksets, door closers, floor hinges and panic devices to the Owner's representative. Provide four (4) blanks for each key type.

#### 1.6 QUALITY ASSURANCE

A. Perform work in accordance with the following requirements:

1. ANSI A117.1
2. NFPA 80.
3. NFPA 101.
4. NFPA 252.
5. UL 10B.
6. UL 305.
7. ADAAG.

DOOR HARDWARE 08710-4

- B. Regulatory Requirements:
1. Conform to the Building Code for requirements applicable to fire-rated doors and frames.
  2. Conform to ADAAG for operation, mounting heights, and location of accessories.
- C. Manufacturer: Company specializing in manufacturing the products specified with a minimum of five (5) years documented experience.
- D. Installer: Company experienced in performing the work of this Section with a minimum of five (5) years documented experience.
- E. Supplier: A recognized architectural finish hardware supplier, who has been furnishing hardware to similar projects for a period of not less than five (5) years, and who employs an experienced architectural hardware consultant (AHC) for the preparation of Hardware Schedules, and consultation about project hardware requirements.
- F. Obtain each type of hardware (latch and lock sets, hinges, closers, etc.) from a single manufacturer.

#### 1.7 DELIVERY, STORAGE AND HANDLING

A. Section 01600 - Product Requirements: Transport, handle, store and protect the products.

B. Supplier to deliver the appropriate hardware, at the proper time and to the proper location (shop or Project Site) for installation.

C. Deliver products to the Project Site in the manufacturer's original, unopened packages, dry and undamaged, bearing the manufacturer's name and identification of the hardware item.

D. Retain the manufacturer's original packaging. Ensure that the products are complete, including basic installation instructions. Label each product separately to be readily identifiable with the products indicated in the Hardware Schedule.

E. Supplier to identify sets with the appropriate hardware set number.

F. Contractor to catalogue the delivered hardware and store in a secure lockable enclosure, i.e. room, storage cabinet, etc.; store off the ground and on shelving. Set up procedures for limited access to the locked storage.

G. Store products in their original protective packaging to prevent soiling, wetting and physical damage to materials, finishes and operating mechanisms.

H. Handle to prevent damage to finish surfaces.

I. Maintain protective covers on all units until installation has been completed. Remove coverings during final clean-up.

#### PART 2 PRODUCTS

##### 2.1 HARDWARE, GENERAL

A. Comply with ANSI / BHMA 156 Series standards applicable to the type and grade of hardware required.

DOOR HARDWARE 08710-5 CENTRAL POLICE PRECINCT



B. Hardware Characteristics: Requirements for design, grade, function, finish, size and other distinctive qualities of each type of finish hardware are indicated in the Hardware Schedule at the end of this Section.

C. Complete Assemblies: Scheduled hardware indicates the primary types and quality of hardware required and is not necessarily descriptive of all the components required. Provide standard accessory components, as necessary, to complete the assembly for a fully functional unit when installed. Provide finishes matching the primary unit where accessory components are exposed-to-view.

D. Anchorage Devices: Furnish with each hardware type required.

1. Types: Wood and machine screws and other appropriate anchorage devices applicable to the type of substrate the item is to be fastened to. Do not provide exposed through-bolts or nuts unless clearly noted on the Hardware Schedule submittal, and approved by the Architect.

2. Head Style: Phillips flat-head devices.

3. Finish: Match the finish of the primary fastened hardware.

E. Finish of Hardware: The finish of hardware shall be as stated herein below. Special care shall be taken to coordinate the finish of the various manufacturers to insure a uniform acceptable finish throughout. The finish of all hardware shall match the finish of the locksets, unless otherwise specified.

F. Hardware manufacturers are listed, within each item Article below, for each hardware item to establish a standard of quality, and minimum functional requirements.

## 2.2 HINGES

A. Subject to compliance with the Project requirements, manufacturers offering products which may be incorporated into the work include the followings, as specified below:

1. Hager.

2. McKinney.

3. Stanley.

4. Henry Soss.

B. Material:

1. Door Butts: Hinges shall be full mortise, template type, unless half mortise hinges are required; stainless steel. Hinges shall have non-rising loose pins, ball or oolite bearings, and flat button tips with matching plugs, except where otherwise specified. Provide hinges with stainless steel pins; steel pins with steel hinges; non-removable pins (NRP) for exterior and public interior exposures, non-rising for non-security exposure.

2. Where necessary to keep the door leaf clear of walls, casings, jambs or reveals in the door opening, furnish wide throw hinges of an approved type shall be furnished. For out-swinging doors, hinges shall have a set screw in the barrel to prevent removal of the pin when the door is closed. All doors over 7'-6" tall shall have one extra hinge for each additional two (2) feet of height, or fraction thereof.

DOOR HARDWARE

08710-6

3. Ball Bearing Type: Swaged, inner leaf beveled, square corners.

4. ANSI 156.1, Grade 1.

## 2.3 LOCKS, LATCHES AND BOLTS

A. Subject to compliance with the Project requirements, manufacturers offering products which may be incorporated into the work include the followings, as specified below:

1. Yale.

2. Arrow.

3. Schlage.

4. Best.

5. Sargent.

B. Materials:

1. Lock Uniformity: Except where otherwise specified, all locksets, latchsets, padlocks, cylinders and component parts, as specified hereinafter, shall be by one manufacturer. All internal parts of locksets, latchsets, padlocks and cylinders shall be brass or stainless steel to resist corrosion, and shall be marine function for exterior doors; US 32D finish.

2. Lockset Style: All hardware shall have lever handles with rose.

3. Locksets: ANSI A156.2, Series 4000 Grade 1, with removable cores.

4. Mortise Locks and Latches: ANSI / BHMA A156.13, Series 1000, Operational Grade 1, Security Grade 2; equip with 6-pin tumbler; 2-3/4" backset; keyed alike, or as approved. Levers and roses shall have screwless shanks, and no exposed fasteners.

5. Bored Locks and Latches: ANSI / BHMA A156.2, Series 4000, Grade 1. Locks for exterior doors shall have threaded roses or concealed machine screws.

6. Latch Sets: Provide release by turning lever, closing door, or turning emergency release key through a hole in the outside knob.

7. Cores: All lockset shall have removable cores to facilitate easy replacement.

a. To maintain the established existing master key system, all cylinder, locksets and padlocks shall be furnished with keyways to match the keyway of record.

b. Furnish with construction cores for use during construction and until Substantial Completion, or until a portion of the work has been accepted by the Owner and the Owner's representative has directed the cores to be change out.

8. Hospital Latches: Push / pull latchsets similar and equal to Glynn-Johnson HL6; 1/2" throw, 2-3/4" backset, to 161 cutout. Cover approximately 2-1/2"; covers and handles of stainless steel, BHMA 630 finish, engraved "PUSH" and "PULL" on handles, push handle pointing up, pull handle pointing down.

DOOR HARDWARE

08710-7

9. Combination Locks: Heavy-duty, mechanical combination locksets with five pushbuttons, standard sized knobs, 3/4" deadlocking latch, 2-3/4" backset. Lock shall be operated by pressing two or more of the buttons in unison or individually in the proper sequence. The inside knob shall always operate the latch. Provide a keyed cylinder on the interior to permit setting the combination.
  10. Strikes: ANSI Strikes, 1-1/4" x 4-7/8". All lock strikes shall have a curved lip of sufficient length to protect the trim and jamb, and shall be furnished with wrought box strikes with extended lip for latch bolts, except open strike plates may be used in wood frames. Provide dustproof strikes for foot bolts.
  11. Door Bolts: ANSI / BHMA 156.16. Provide dustproof strikes for bottom bolts, except for doors having metal thresholds. Automatic latching flush bolts: ANSI / BHMA A156.3, Type 25.
  12. Door Hardware: Hand of lock shall be as shown on the Drawings. If the door hand is changed during construction, the Contractor shall make the necessary changes in the hardware at no additional cost to the Owner.
  13. Lever Handles: All latch and locksets shall have lever handles with a rose. Lever handles for exit devices shall meet the test requirements of ANSI / BHMA A 156.13 for mortise locks. Provide knurled or abrasive-coated lever handles for doors accessible to blind persons, and those which lead to dangerous areas.
  14. Cipher Locks: Exterior Grade and Weather Resistant; Stand Alone ANSI/BHMA Grade 1; pushbutton keypad with at least 500 unique PIN codes, programming master code, passage mode, low battery indicator and 9-V battery power backup; keypad lockout feature; key override; and freewheeling outside lever in locked position.
- C. Keying, General:
1. All locksets, padlocks and cylinders shall be keyed, master keyed and grand master keyed at the factory where records shall be established and maintained, as directed.
    - a. All master keys and grand master keys shall be identified with a registry number, not stamped with "Master" or the letter "M".
    - b. Individual room keys shall not be stamped with a key cut, but with a plain identification number only.
  2. Maintain a security system to ensure that keys used during construction will not open doors after occupancy.
  3. Provide three (3) keys for each lockset.
  4. A Keying Schedule will be provided after the initial Hardware Schedule submittal. Keyed alike and master keying will be finalized at that time.
  5. Furnish exterior door lock sets with removable I/C core cylinders and cylinder guards.
  6. Restrict the distribution of construction keys. Maintain a record of all persons who receive keys and provide a copy of the record to the Owner's representative upon request.

DOOR HARDWARE

08710-8

2.4 PUSH / PULL UNITS

7. When directed by the Owner's representative, remove the construction cores, install permanent cores, and return the construction cores to the manufacturer.
- A. Subject to compliance with the Project requirements, manufacturers offering products which may be incorporated into the work include the followings, as specified below:
1. H. B. Ives.
  2. Quality Hardware Manufacturing Co., Inc.
  3. Trimco.
  4. Rockwood.

B. Materials: ANSI A156.6 for 0.050 inch thickness.

2.5 EXIT DEVICES (PANIC HARDWARE)

- A. Subject to compliance with the Project requirements, manufacturers offering products which may be incorporated into the work include the followings, as specified below:
1. Corbin Russwin.
  2. Yale.
  3. Von Duprin.
  4. Adams Rite.
  5. Monarch.
  6. Sargent.
- B. Materials:
1. Exit Devices: ANSI / BHMA A156.3, Grade 1. Provide adjustable strikes for rim type and vertical rod devices. Provide open back strikes for pairs of doors with mortise and vertical rod devices.
  2. Exit Locks With Alarm: ANSI / BHMA A156.5, Type E0431 (with full-width horizontal actuating bar) for single doors; Type E0431 (with actuating bar) or E0471 (with actuating bar and top and bottom bolts, both leaves active) for pairs of doors, unless otherwise specified. Provide terminals for connection to a remote indicating panel. Provide outside control key. Coordinate with the electrical subcontractor.
  3. All exposed metal shall match the hardware.
  4. Size and mount the units as indicated or, if not indicated, to comply with the manufacturer's recommendations for the exposure condition. Reinforce the substrate as recommended.
  5. ANSI A156.3 Exit Device and Trim, Grade 1, surface-mounted vertical rod device with dust-proof strike at the head and threshold.

DOOR HARDWARE

08710-9

2.6 CLOSERS

A. Subject to compliance with the Project requirements, manufacturers offering products which may be incorporated into the work include the followings, as specified below:

1. LCN.
2. Norton.
3. Sargent.
4. Corbin Russwin.
5. Rixon-Firemark.
6. Yale.
7. Dorma.

B. Materials and features:

1. ANSI A156.4, Grade 1.
2. ANSI A117.1.
3. Non-Sized; adjustable 1-5.
4. 180 degree door opening.
5. Heavy-duty parallel arm.
6. Standard cover.
7. Exposed metal to match the hardware.

8. Mounting: Hinge face mounting. Do not mount closers on the exterior side of doors.

9. Size and mount units as indicated or, if not indicated, comply with the manufacturer's recommendations for the exposure condition. Reinforce the substrate as recommended.

10. Provide drop brackets, mortise shoes, and long arms, as required.

11. Closers attached to mineral core or particle filled doors shall be installed with sex bolts.

12. Closers to be installed to allow the door to swing as shown on the Drawings.

13. All closers shall be ADAAG type, adjustable for spring setting, latch and sweep speed, and backcheck.

2.7 STOPS, HOLDERS AND BUMPERS

A. Subject to compliance with the Project requirements, manufacturers offering products which may be incorporated into the work include the followings, as specified below:

DOOR HARDWARE

08710-10

1. H. B. Ives.

2. Quality Hardware Manufacturing Co., Inc.

3. Trimco.

4. Dor-O-Matic.

5. Glenn-Johnson.

B. Materials:

1. Door Stop Mounting: Utilize the appropriate anchor method for the substrate encountered (plastic anchor, drywall anchor, expansion shield).

2. Provide resilient grey rubber bumpers.

3. Adjust the height of floor stops to suit the undercut of the adjacent door, and for out-swinging exterior doors.

2.8 THRESHOLDS

A. Subject to compliance with the Project requirements, manufacturers offering products which may be incorporated into the work include the followings, as specified below:

1. Pemko.
2. National Guard.
3. Reese.
4. Wooster.
5. Zero.

B. Thresholds by type:

1. Type as scheduled or indicated, or where not shown provide a manufacturer's standard aluminum threshold, with standard cast or extruded non-slip profile. For out-swinging exterior doors use vinyl or silicone rubber inserts in the face of the stop. 2005V profile by Pemko, or as approved; non-slip.

2. Thresholds shall be one-piece, continuous the full width of the doorway.

3. Where not indicated, the dept of the flat portion of the threshold to be not less than the door frame depth.

4. End Returns: Mitered and returns where ends would otherwise be exposed; of material / finish to match the primary threshold unit.

5. Height: As indicated, except do not exceed 1/2" in height where handicapped access is required. Comply with ADAAG.

6. Method of fastening: Provide the manufacturer's special concealed fastener system for installation for single units.

DOOR HARDWARE

08710-11

7. Sealant: For thresholds, single component, urethane complying with Section 07900 - Joint Sealers.
- 2.9 WEATHERSTRIPPING
- A. Subject to compliance with the Project requirements, manufacturers offering products which may be incorporated into the work include the followings, as specified below:
1. Pemko.
  2. Reese.
  3. Zero.
- B. Continuous Adhesive-Applied Jamb & Head Weatherstripping: Continuous at jambs and head. Air leakage of weatherstripped doors shall not exceed 0.5 CFM of air per square foot or door when tested in accordance with ASTM E 283. Pemko PK88BL, or approved equal.
- 2.10 LIGHT PROOFING AND SOUNDPROOFING
- A. Subject to compliance with the Project requirements, manufacturers offering products which may be incorporated into the work include the followings, as specified below:
1. National Guard.
  2. Pemko.
  3. Zero.
- B. A set shall include adjustable door stops at the head and jambs of doors, and an automatic door bottom of extruded aluminum, anodized finish, surface-applied, with vinyl fin seals between the plunger and housing. Door stops shall have a solid neoprene tube, silicone rubber, or closed-cell sponge gasket. Door bottoms shall have an adjustable operating rod and silicone rubber or closed-cell sponge neoprene gasket. Door stops shall be mitered at the corners.
- 2.11 MISCELLANEOUS HARDWARE
- A. Subject to compliance with the Project requirements, manufacturers offering products which may be incorporated into the work include the followings, as specified below:
- B. Products:
1. Smoke Seals: Fire-tested, continuous at jambs and head; PK 55 by Pemko, or approved equal, color as selected.
  2. Bottom Sweep: 307 by Pemko, or approved equal, color as selected.
  3. Overlap Astragal: 18 gauge minimum, but not less than required for the tested assembly provided for; 357 by Pemko, or approved equal, color as selected.
  4. Split Astragal for doors: 18 gauge minimum, but not less than required for the tested assembly provided for; 309 by Pemko, or approved equal, color as selected.
  5. Door Rain Drips: Extruded aluminum, not less than 0.08" thick, approximately

- 1-1/2" high x 5/8" projection, as selected. Align the bottom with the bottom edge of the door.
6. Overhead Rain Drip: Extruded aluminum, not less than 0.08" thick, approximately 1-1/2" high x 2-1/2" projection, with length equal to the overall door frame width. Align the bottom with the door frame rabbet; 346 by Pemko, or approved equal, color as selected.

2.12 SUBSTITUTIONS

- A. Section 01600 - Product Requirements: Product Options: Substitutions permitted.

2.13 FABRICATION

- A. Finish and Base Material Designations: Number indicate BHMA Code or nearest traditional U.S. commercial finish.
- B. Where base material and quality of the finish are not otherwise indicated, provide at least commercially recognized marine quality as specified in the applicable Federal Specifications.

PART 3 EXECUTION

3.1 EXAMINATION

- A. Section 01700 - Execution Requirements: Verification of existing conditions before starting the work.
- B. Verification of Conditions: Verify that field measurements, surfaces, substrates and conditions are as required, and ready to receive the work.
1. Verify that doors and frames are ready to receive the work, and that dimensions are as instructed by the manufacturer.
- C. Report in writing, prevailing conditions that will adversely affect satisfactory execution of the work of this Section. Do not proceed with the work until unsatisfactory the conditions have been corrected.

3.2 INSTALLATION

- A. Where not specified under other Sections to be performed by the manufacturer or supplier, machine, fit and drill wood and metal doors, and frames.
- B. Prepare doors of the various types to receive hardware, using templates and instructions provided with the hardware items for on-site work.
- C. Install each hardware item in compliance with the manufacturer's instructions and recommendations.
- D. Wherever cutting and fitting is required to install hardware onto or into surfaces which are later to be painted or finished in another way, coordinate the hardware removal, storage and reinstallation, or the application of surface protection with the finishing work specified in Section 09900 - Painting. Do not install / reinstall surface-mounted items until the finishes have been completed on the substrates.

DOOR HARDWARE

08710-12

DOOR HARDWARE

08710-13

- 3.3 ADJUSTING
- E. Set units level, plumb and true to line and location. Adjust and reinforce the attachment substrate as necessary for proper installation and operation.
  - F. Drill and countersink units not factory-prepared for anchorage fasteners, flush with the fastened surface. Space fasteners and anchors in accordance with industry standards.
  - G. Set thresholds for exterior doors in a full bed of sealant to ensure waterproof integrity.
- 3.4 FIELD QUALITY CONTROL
- A. Section 01700 - Execution Requirements: Adjusting the installed work.
  - B. Adjust and check each operating item of hardware and each door to ensure proper operation and function of every unit. Replace units which cannot be adjusted to operate freely and smoothly for their intended application.
  - C. Adjust door control devices to compensate for the final operation of cooling and ventilating equipment.
  - D. Door operation shall meet ADAAG requirements for opening force.
  - E. Adjust operating hardware to provide a tight fit at contact points and weatherstripping, for smooth operation and weathertight closure.
  - F. Lubricate moving components and hardware.
  - G. Final Adjustment: Whenever hardware installation is made more than one month prior to acceptance or occupancy of a space or area, return to the work during the week prior to acceptance or occupancy, and make a final check and adjustment of all hardware items.
- 3.5 CLEANING
- A. Section 01450 - Quality Control: Field inspection.
  - B. Inspect hardware installations for proper locations, heights, level, plumb, square, attachment to the substrate and opening force.
- 3.6 TRAINING
- A. Instruct the Owner's personnel in the proper adjustment and maintenance of hardware items and finishes during final adjustment of the hardware.

3.7 HARDWARE SCHEDULE

A. Door Material Types:		Aluminum	OHC	Overhead Coiling
AL	Folding Grille	Chain Link Gate	SCWD	Solid Core Wood
GATE	Hollow Core Wood	Hollow Metal	SLGL	Sliding Glass
HCWD			WD	Wood
HM				
<u>HW-1 Exterior AL Double Exit Door</u>				
Hinges	3 pairs	By Manufacturer		
Exit Device	2 ea	By Door Manufacturer		
	1 ea	F-110 Lever		
Closer	1 ea	Dummy Trim		
Flush Bolts	2 ea	Surface mount interior		Alum
Weatherstripping	1 set	Top and Bottom		US32D
Threshold	continuous	By Door Manufacturer		Alum
Astragal	continuous	As indicated		Alum
Rain Drip				Alum
		Provide ADA Door Operator		
<u>HW-2 Exterior AL Door</u>				
Hinges	1-1/2 pairs	By Manufacturer		US26D
Lockset	1	F-110 Lever		
Closer	1 ea	Provide Cipher Lock where scheduled.		Alum
Weatherstripping	continuous	Surface mount interior		Alum
Threshold	continuous	By Door Manufacturer		Alum
Astragal		As indicated		Alum
Rain Drip				
<u>HW-3 Security Gates and Roll-up door</u>				
		Heavy Duty Hinges, 4 pairs each except roll-up door.		
		Heavy Duty Padlock, 2 each		
		Locking Bottom Bolt (for swinging gate)		
<u>HW-4 Interior SCWD and HM Doors, Fire Rated where scheduled</u>				
Hinges	1-1/2 pairs	A5112, 4-1/2 x 4-1/2		US32D
Lockset	1	F82		US26D
Closer	1 ea	F87 at secure interview rooms		Alum
Door Stop	1 ea	Provide Cipher Lock where scheduled.		US32D
Door Gasketing	continuous	Surface Mount		Roy 154
Closer	1 ea	Floor		Alum
		Surface mount interior		

DOOR HARDWARE

08710-15

HW-5 Interior SCWD / HM Restroom Doors (w/ Vent) Fire Rated where scheduled

Hinges	1-1/2 pairs	By Manufacturer	US26D
Lockset	1	F76	
Closer	1 ea	F87 at secure areas	
Kick Plate	1 ea	Surface mount	Alum
Door Stop	1 ea	10" x width	US32D
Door Gasketing	continuous	Floor or wall	US32D
			Roy 154

HW-6 Interior SCWD Doors (Storage Closets)

Hinges	1-1/2 pairs	A5112, 4-1/2 x 4-1/2	US32D
Exit Device	1 ea	By Door Manufacturer	
	1 ea	F84 Lever	US26D
Closer	1 ea	Surface Mount	Alum
Door Stop	1 ea	Floor	US32D
Door Gasketing	continuous		Roy 154
Closer	1 ea	Surface mount interior	Alum

END OF SECTION

SECTION 08800  
GLASS AND GLAZING

PART 1 - GENERAL  
1.1 SUMMARY

A. Section Includes:

1. Glazing for entrances and storefronts.
2. Glazing for curtain walls.
3. Glazing for sliding doors.
4. Glazing for window units.
5. Interior partitions relites.
6. Fire-rated glazing.
7. Low-E glazing.
8. Glass blocks.
9. Glazing sealant installation.
10. Bulletproof glass.

B. Related Documents: The Contract Documents, as defined in Section 01010 - Summary of Work, apply to the work of this Section. Additional requirements and information necessary to complete the work of this Section may be found in other Documents.

C. Related Sections:

1. Section 01811 - Sustainable Design and Construction Procedures
2. Section 06200 - Finish Carpentry: Wood frames for interior glazing.
3. Section 07900 - Joint Sealers: Sealants for waterproofing glazing installations.
4. Section 08100 - Hollow Metal Doors and Frames: Glazing in metal doors and sidelites.
5. Section 08210 - Wood Doors: Glazing in wood doors, transoms and sidelites.
6. Section 08330 - Overhead Doors: Glazing in sectional doors.
7. Section 08400 - Entrances, Storefronts and Windows: Glazing installations.
8. Section 08420 - Aluminum Doors and Windows: Glazing in doors and windows.
9. Mirrors are specified in Section 10810 - Toilet Accessories.

1.2 DESCRIPTION OF WORK

GLASS AND GLAZING 08800-1

DOOR HARDWARE 08710-16

A. The extent of glass and glazing work is indicated on the Drawings and Schedules and as specified herein, and includes providing and installing glazing for exterior and interior doors and windows, safety glass, interior relites, glass blocks, sealants and miscellaneous glazing materials.

1.3 REFERENCES

- A. The publications listed below form a part of this Specification to the extent referenced. Publications are referred to in the text by basic designation only.
- B. American Society of Civil Engineers (ASCE):
1. ASCE / SEI7 - Minimum Design Loads for Buildings and other Structures.
- C. American National Standards Institute (ANSI):
1. ANSI Z97.1 - Safety Performance Specifications and Methods of Test for Safety Glazing Material Used in Buildings.
- D. American Society for Testing and Materials (ASTM):
1. ASTM C 920 - Specification for Elastomeric Joint Sealants.
  2. ASTM C 1036 - Specification for Flat Glass.
  3. ASTM C 1048 - Specification for Heat-Treated Flat Glass - Kind HS, Kind FT Coated and Uncoated Glass.
  4. ASTM E 1996 - Specification for Performance of Exterior Windows, Curtain Walls, Doors, and Impact Protective Systems Impacted by Windborne Debris in Hurricanes.
  5. ASTM F 1233 - Test Method for Security Glazing Materials and Systems.
- E. Flat Glass Marketing Association (FGMA):
1. FGMA - Glazing Manual and Glazing Sealing Systems Manual.
- F. National Fire Protection Agency (NFPA):
1. NFPA 257 - Standard on Fire Tests for Window and Glass Block Assemblies.
- G. International Code Council:
1. International Building Code (IBC), 2009:
- H. U. S. Consumer Product Safety Commission, CPSC 16 CFR, Part 1201 - Safety Standard for Architectural Glazing Materials.

1.4 CONSTRUCTION

A. Interface with Other Work: Coordinate glazing with the installation of exterior aluminum entrances, storefronts, curtain walls, doors and windows as specified in Section 084.10 hollow metal doors and windows specified in Section 08100; wood doors and windows specified in Section 08210.

1.5 SUBMITTALS

GLASS AND GLAZING 08800-2

A. Section 01330 - Submittal Procedures: Procedures for submittals.

1. Product Data:
  - a. Submit two (2) copies of the manufacturer's catalogs, including specifications and installation instructions for all glass products to be used and for glazing sealant and compound, gasket and miscellaneous materials required.
  - b. Glass: For each type of glass provide structural, physical and environmental characteristics, size limitations, special handling and installation requirements.
  - c. Glazing compound: Provide chemical, functional, and environmental characteristics, limitations and special application requirements.
  - d. Manufacturer's engineering design to meet the performance requirements.
2. Calculations indicating glazing satisfaction of performance requirements
3. LEED Requirement: Actual light transmission level calculation to achieved LEED credit required for this project.
  - a. Complete the LEED Materials Submittal Form as provided in Section 01340 - Submittals - LEED Submittals, for procedures in this section.
  - b. Complete the LEED VOC Submittal Form as provided in Section 01340 - Submittals - LEED Submittals, for products in this section.
4. Samples:
  - a. Glass: Two (2) samples 6" x 6" in size for each type of glazing, illustrating tinting, and finish of the glazing material. Label each sample indicating kind, quality and manufacturer as follows:
    - 1) Tinted float glass.
    - 2) Laminated glass.
    - 3) Tempered glass.
    - 4) Low-e glass.
    - 5). Patterned glass.
  - b. Glass Blocks: Two (2) full size units.
  - c. Glazing Sealants: Three (3) copies of the manufacturer's standard color selection.
5. Assurance / Control Submittals:
  - a. Manufacturer's certificate that the products meet or exceed the specified requirements.

GLASS AND GLAZING 08800-3

- b. Calculations indicating that the materials satisfy the performance requirements.
  - c. Documentation of experience indicating compliance with the specified qualifications requirements.
- B. Section 01780 - Closeout Submittals: Procedures for closeout submittals.
- 1. Warranty: Submit a written Warranty with forms completed in the name of the Owner and registered with the manufacturer.
- 1.6 QUALITY ASSURANCE
- A. Qualifications:
- 1. Manufacturer: Company specializing in manufacturing the products specified with a minimum of five (5) years documented experience.
  - 2. Installer: Company experienced in performing the work of this Section with a minimum of five (5) years documented experience.
- B. Performance Requirements:
- 1. Provide the capacity to withstand the following loading requirements for exterior units:
    - a. Design and install to resist combined positive and negative windloading in accordance with IBC 2009, Section 1609 with a Vmph of 170, qs of 74.0 psf, exposure [C] [D], and importance factor [1.0] [1.25] [1.5], as applicable per ASCE 7. Size for areas of discontinuity and worst case scenario to be experienced by the building.
    - b. Height of windows and door units above the ground level are indicated on the Drawings or can be calculated from the Drawings.
  - C. Identification: Provide labels where safety glazing is required. Each unit of tempered glass shall be permanently identified by the manufacturer. The identification shall be etched or ceramic fired on the glass and shall be visible after the glazing has been installed. Label per NFPA 80.
  - D. Grading and Labeling: Grade and label each light stating the quality and grade of the glass and the manufacturer's name and brand designation. Leave labels intact until removal is directed by the Owner's representative. Label each individual glazing unit for fire-rated doors and windows in accordance with NFPA 80-1-7.4. Listing marks shall be visible after installation.
  - E. Perform the work in accordance with the FGMA, Glazing Manual.
  - F. All exterior glazing shall be wet sealed glazing gaskets and permitted only for interior work.
- 1.7 DELIVERY, STORAGE AND HANDLING
- A. Section 01600 - Product Requirements: Transport, handle, store, and protect the products.
  - B. Comply with the manufacturer's instructions for shipping, handling, storing and protecting

GLASS AND GLAZING 08800-4

- glass and glazing products.
- C. Deliver products to the Project Site in the manufacturer's original, unopened packaging or crates.
- D. Exercise exceptional care to prevent edge damage to the glass, rainbowing, discoloration and damage to and deterioration of coatings, if any, on the glass.

1.8 JOB CONDITIONS

- A. Pre-installation: Meet with the Glazier and other trades affected by the glass installation prior to beginning installation. Do not perform work under adverse weather or job conditions. Install liquid sealants only when the temperature is within the lower or middle one third of the temperature range recommended by the manufacturer.

1.9 WARRANTY

- A. Section 01780 - Closeout Submittals: Procedures for closeout submittals.
- B. Special Warranty:
  - 1. Provide a manufacturer's written Warranty against cracking, breakage, staining, rainbowing, discoloration and for replacement.
  - 2. Warranty Period: Two (2) years from the date of Substantial Completion.

PART 2 - PRODUCTS

2.1 MANUFACTURERS

- A. Subject to compliance with the Project requirements, manufacturers offering products which may be incorporated into the work include the following:
  - 1. Falconer Glass Industries, Inc.
  - 2. Guardian Industries.
  - 3. PPG Industries.
  - 4. Libby-Owens-Ford.
  - 5. Pilkington.
  - 6. Viracon, Inc.
  - 7. Oldcastle Glass.
  - 8. National Glass Blocks.
- B. Section 01600 - Product Requirements: Product Options: Substitutions permitted.

2.2 GLAZING MATERIALS

- A. Standards:
  - 4. Prime Glass: FS DD-G-451, ASTM C 1036.

GLASS AND GLAZING 08800-5



5. Safety Glass: CPSC 16 CFR 1201.
6. Heat-Treated Glass: FS DD-G-1403, ASTM C 1048.
- B. Float / Plate Glass: Type 1, quality q3, thickness as required to meet the performance requirements, but not less than 3/16", clear unless otherwise indicated. Curved or straight as indicated.
- C. Laminated Safety and Security Glass: Standard two-ply laminated glass with minimum 0.060" Saflex interlayer. Thickness as required to meet the Performance Requirements or security criteria for the location, height and use or as indicated, but not less than 3/8". Where glazing is double pane, the laminate shall be installed as the exterior lite. Tint color as selected.
1. Impact Loads: Comply with South Florida Building Code, Section 2315 and 3513.
- D. Tempered Glass: Heat treated to strengthen the glass in bending to not less than 4.5 times the annealed strength, edges seamed, thickness as required to meet the performance requirements (3/16" thick, minimum). Exposed edges in the finished work shall be polished. Tint color as selected.
1. Where indicated as <sup>Δ</sup>Free of Tong Marks<sup>®</sup>, provide tempered glass produced by manufacturer's special process which eliminates long marks.
- E. Tempered Low-E: Hard coating on surface 4. Tint color as selected from manufacturer's standards.
- F. Polished Wired Glass or Patterned Wire Glass: Type II, minimum 1/4-inch thick, Class 1, Form 1, quality q11, clear and polished both faces. Pattern as selected.
1. Fire Rating: Provide glass listed and labeled by UL <sup>Δ</sup>fire resistance<sup>®</sup> complete with steel channel stops.
- G. Interior Fire Rated: Fire glass/mullion glazing system with pyrostop safety rated glass.
- H. Patterned Glass: Tempered glass with screen-printed, ceramic frit fused pattern.
1. PPG / DecoTherm.
2. Viracon, Viraspan.
3. Approved equal.
- I. Bullet-proof Glass: meet or exceed UL Level III (9mm full metal jacket with lead core, 0.357 magnum jacketed lead soft point, 0.44 magnum lead semi wadcutter).
1. Transaction Window.
- a. Non-ricochet type intended to permit the encapture and retention of an attacking projectile lessening the potential of a random injury or lateral penetration.
- b. Stainless Steel dip tray with single or multiple transaction positions.
- c. Natural voice configuration.
- A. Glass Blocks: 8" x 8" x 4" thick or as indicated, partially evacuated hollow units. Style, pattern and color as selected from the manufacturer's standards.
- 2.4 GLAZING SEALANT
- A. Silicone: Single component, elastomeric, chemical curing; capable of water immersion without loss of properties; non-bleeding, non-staining, non-sag; cured Shore A hardness of 15 - 25. Color black.
- 2.5 MISCELLANEOUS GLAZING MATERIALS
- A. Cleaners, Primers and Sealers: Type recommended by the glazing sealant or gasket manufacturer.
- B. Setting Blocks: Neoprene of EPDM, 70 to 90 Shore A durometer hardness; compatible with the glazing sealant used.
- C. Spacers: Neoprene of EPDM, 40 to 50 Shore A durometer hardness; self adhesive on one side; compatible with the glazing sealant used.
- D. Filler Rods: Closed cell or waterproof jacketed foam rod of polyethylene, butyl, neoprene, polyurethane, or vinyl; compatible with the glazing sealant used.
- 2.6 GLASS BLOCK GLAZING ACCESSORIES
- A. Panel reinforcement: Two (2) parallel 9 gage wires either at 1-5/8" or 2" on center with electrically welded cross wires at regular intervals, galvanized after welding.
- B. Expansion Strips: Fibrous glass or polyethylene foam, 3/8" thick.
- C. Panel Anchors: 20 gage perforated steel strips, 24" long x 1-3/4" wide, galvanized after perforating.
- D. Sealant: Sealant No. 1 or No. 3 per Section 07900.
- E. Backer Rods: Polyethylene foam, neoprene or equal as approved by the sealant manufacturer.
- F. Mortar Materials: Type S in accordance with ASTM C 270 with integral type water-repellant added to the mortar mix.
- G. Portland Cement: Type 1 in accordance with ASTM C 150.
- H. Lime: Type S in accordance with ASTM C 207.
- I. Sand: Clean, white quartzite type, essentially free of iron compounds; for thin joints in accordance with ASTM C 144.
- J. Integral Type Water-repellant: Stearate as recommended by the glass block manufacturer.

PART 3 - EXECUTION

3.1 STANDARDS AND PERFORMANCE

- 2.3 GLASS BLOCKS 08800-6
- GLASS AND GLAZING
- A. Watertight and airtight installation of each glass product is required, except as otherwise
- GLASS AND GLAZING 08800-7 CENTRAL POLICE PRECINCT

shown. Each installation must withstand normal temperature changes, wind loading, and impact loading (for operating sash and doors), without failure including loss or breakage of glass, failure of sealants or gaskets to remain watertight and airtight, deterioration of glazing materials, and other defects in the work.

- B. Protect glass from edge damage during handling and installation, and subsequent operation of glazed components of the work. During installation, discard units with significant edge damage or other imperfections.
- C. Glazing channel dimensions, as indicated and specified, are intended to provide for the necessary bite on the glass, minimum edge clearances, and adequate sealant thickness with reasonable tolerances. Adjust as required by the job conditions at the time of installation. Do not reduce the manufacturer's recommended minimum edge bite on the glass.
- D. Comply with the combined recommendations and technical reports by manufacturers of the glass and glazing products used in each glazing channel, and with recommendations of the Flat Glass Marketing Association, a Glazing Manual®, except where more stringent requirements are indicated.
- E. Inspect each piece of glass just prior to installation, and discard any which have observable edge damage or face imperfections.
- F. Provide safety glass for all glazed panels within 48" of a door and where glazed panels are less than 60" above any floor or any walking surface and elsewhere where required by the Building Code, performance data or as indicated.
- G. Clean glazing channels and other framing members to receive glass just prior to glazing. Remove coatings which are not firmly bonded to the substrate. Remove lacquer from metal surfaces where elastomeric sealants are used.
- H. Apply primer or sealant to joint surfaces where recommended by the sealant manufacturer.

### 3.2 EXAMINATION

- A. Section 01700 - Execution Requirements: Verification of existing conditions before starting the work.
- B. Verification of Conditions: Verify that field measurements, surfaces, substrates and conditions are as required, and ready to receive the work.
  1. Verify that openings for glazing are correctly sized and within tolerance.
  2. Verify that surfaces of glazing channels or recesses are clean, free of obstructions that may impede moisture movement and that weeps are clear and ready to receive the glazing.
- C. Report, in writing, prevailing conditions that will adversely affect satisfactory execution of the work of this Section. Do not proceed with the work until the unsatisfactory conditions have been corrected.

### 3.3 PREPARATION

- A. Clean contact surfaces with solvent and wipe dry.
- B. Seal porous glazing channels or recesses with substrate compatible primer or sealer.

GLASS AND GLAZING 08800-8

- C. Prime surfaces scheduled to receive sealant.

### 3.4 GLAZING INSTALLATION

- A. Place setting blocks of the proper size in sill rabbet; locate at 1/4th the glass width from each corner; set blocks in a thin course of heel and toe compound, if any.
- B. Install spacers of the proper size and spacing inside and out for glass sizes larger than 50 united inches, except where gaskets or pre-shimmed tape is used. Provide 1/8" minimum bite of spacers on the glass and use a thickness slightly less than the final compressed thickness of the tape.
- C. Set each unit of glass in each series in uniformity with other pieces in pattern, draw, bow, and other visually perceptible characteristics.
- D. Provide for the following edge clearances (bite):
 

<u>Single glazed</u>	
Nominal edge cover (bite)	5/16"
Minimum nominal edge clearance	3/16"
Minimum face clearance	3/16"
- E. Glass must be edge blocked to prevent contact with metal framing.
- F. Provide glazing sealant as required for the particular glazing application. Coordinate with other Sections herein for material compatibility. Glazing gaskets are permitted only for interior locations.
- G. Prevent exudation of the sealant or compound by forming voids or installing filler rods in channels at the heel of jambs and heads, except as otherwise indicate and depending on the light size, thickness and type of glass, and in compliance with the manufacturer's recommendations.
- H. Provide filler rod where sealants are used in the following locations:
  1. Head and jamb channels.
  2. Tinted glass over 75 united inches in size.
  3. Clear glass over 125 united inches in size.
- I. Do not leave voids in sill channels except as specifically indicated or recommended by the glazing manufacturer. Force sealant into the channel to eliminate voids and to ensure complete wetting® or bond of the sealant to the glass and channel surfaces.
- J. Do not allow the sealant to close the weeps of aluminum framing.
- K. Tool exposed surfaces of glazing liquids and compounds to provide a substantial wash® away from the glass.
- L. Clean and trim excess glazing materials from glass and stops or frames promptly after installation; eliminate stains and discolorations.
- M. Install pressurized tape and gaskets to protrude slightly out of the channel to eliminate dirt

GLASS AND GLAZING 08800-9

and moisture pockets.

### 3.5 GLASS BLOCK INSTALLATION

- A. Verify that channels, chases and panel anchors have been provided at heads and jambs for panel support within openings.
- B. Cover the sill area with a heavy coat of asphalt emulsion. Allow the emulsion to dry before placing mortar. Adhere expansion strips to jambs and head. Make certain that expansion strips extend to the sill. Maintain a uniform joint width of 1/4" plus or minus 1/8". All mortar joints must be full and not furrowed. Steel tools should not be used to tap blocks into position.
- C. Install reinforcing at 16" o.c. horizontally and in joints immediately above and below all openings within panels. Run the reinforcing continuously from edge to edge of panels. Lap reinforcing not less than 6" where necessary to use more than one length. Do not bridge expansion joints with reinforcing. Install reinforcing as follows:
  1. Place lower half of mortar in bed joint. Do not furrow. Press panel reinforcing into place. Cover panel reinforcing with upper half of mortar bed and trowel smooth. Do not furrow.
  2. Strike joints smooth while mortar is still plastic and before final set. Rake out all spaces requiring sealant to a depth equal to the width of the spaces. Remove surplus mortar from the faces of glass blocks and wipe dry. Tool joints smooth and concave before mortar takes final set.
  3. After final mortar set, install packing tightly between glass block panel and head construction. Apply sealant evenly in the head and jamb recesses in accordance with the manufacturer's instructions.

### 3.6 FIELD QUALITY CONTROL

- A. Section 01450 - Quality Control: Field inspection.
- B. Inspect the preparation for and installation of glazing.

### 3.7 CLEANING

- A. Section 01700 - Execution Requirements: Cleaning the installed work.
- B. Remove non-permanent labels after glazing has been completed and clean glass surfaces.
- C. Wash and polish glass on both surfaces not more than four (4) days prior the date scheduled for inspections intended to establish the date of Substantial Completion for each area of the Project. Wash with a solution of mild detergent in warm water applied with soft, clean wiping cloths. Take care to remove dirt from corners. Wipe surfaces clean and dry.

### 3.8 PROTECTION

- A. Section 01700 - Execution Requirements: Protection of the installed work.
- B. Protect exterior glass from breakage immediately upon installation by use of crossed streamers attached to framing and held away from the glass. Do not apply markers directly to the glass surface.

GLASS AND GLAZING 08800-10

GLASS AND GLAZING

08800-11

- C. Remove and replace glass which has been broken, chipped, cracked, abraded or damaged in other ways during the construction period, including by natural causes, accidents and vandalism.

END OF SECTION

SECTION 09300

TILE

PART 1 GENERAL

1.1 SUMMARY

A. Section Includes:

1. Floor tile and base tile.
2. Quarry floor and base tile.
3. Ceramic wall tile, shapes and trim units.
4. Porcelain floor tile.
5. Stair tile.
6. Marble threshold.
7. Mortar and grout.
8. Sealer.
9. Metal edge strips.
10. Waterproofing membrane.
11. Tile feature strips and patterns set in paving.

B. Related Documents: The Contract Documents, as defined in Section 01010 - Summary of Work, apply to the work of this Section. Additional requirements and information necessary to complete the work of this Section may be found in other Documents.

C. Related Sections:

1. Section 03300 - Cast-In-Place Concrete: Substrate for application.
2. Section 04230 - Reinforced Unit Masonry: Substrate for application.
3. Section 09250 - Gypsum Board: Substrate for application.
4. Section 07900 - Joint Sealers: Sealant at tile penetrations and dissimilar materials.

1.2 DESCRIPTION OF WORK

A. The extent of the tile work is indicated on the Drawings and Schedules and as specified herein, and includes providing and installing floor, base and wall units made from clay and other ceramic materials, marble thresholds, waterproofing membrane under tile, metal edge strips, mortar and grout, sealing of expansion and other joints, and feature strips, patterns and accent tiles.

TILE 09300-1

B. Definition: The term **Tile**® includes ceramic surfacing units and trim made from clay or other ceramic materials.

C. Joint sealants are specified in Section 07900 - Joint Sealers.

1.3 REFERENCES

A. The publications listed below form a part of this Specification to the extent referenced. Publications are referred to in the text by basic designation only.

B. American National Standards Institute (ANSI):

1. ANSI A108.4 - Installation of Ceramic Tile with Organic Adhesives or Water Cleanable Tile-Setting Epoxy Adhesive.
2. ANSI A108.5 - Installation of Ceramic Tile with Dry-Set Portland Cement Mortar or Latex-Portland Cement Mortar.
3. ANSI A108.10 - Installation of Grout in Tilework.
4. ANSI A118.1 - Specifications for Dry-Set Portland Cement Mortar.
5. ANSI A118.4 - Specifications for Latex-Portland Cement Mortar.
6. ANSI A118.6 - Specifications for Standard Cement Grouts for Tile Installation.
7. ANSI A136.1 - Organic Adhesives for Latex Portland Cement Mortar.
8. ANSI A137.1 - Specification for Ceramic Tile.

C. American Society for Testing and Materials (ASTM):

1. ASTM C 373 - Test Method for Water Absorption, Bulk Density, Apparent Porosity, and Apparent Specific Gravity of Fired Whiteware Products.
2. ASTM C 482 - Test Method for Bond Strength of Ceramic Tile to Portland Cement Plaster.
3. ASTM C 485 - Test Method for Measuring Warpage of Ceramic Tile.
4. ASTM C 499 - Test Method for Facial Dimensions and Thickness of Flat, Rectangular Ceramic Wall and Floor Tile.
5. ASTM C 501 - Test Method for Relative Resistance to Wear of Unglazed Ceramic Tile by the Taber Abraser.
6. ASTM C 502 - Test Method for Wedging of Flat, Rectangular Ceramic Wall and Floor Tile.
7. ASTM C 648 - Test Method for Breaking Strength of Ceramic Tile.
8. ASTM C 650 - Test Method for Resistance of Ceramic Tile to Chemical Substances.
9. ASTM C 1028 - Test Method for Determining the Static Coefficient of Friction of Ceramic Tile and Other Like Surfaces by the Horizontal Dynamometer Pull-Meter

TILE 09300-2

- Method.
- D. Americans with Disabilities Act Accessibility Guidelines (ADAAG);
1. Accessibility Guidelines for Buildings and Facilities.
- E. Tile Council of America, Inc. (TCA):
1. Handbook for Ceramic Tile Installation.
- 1.4 SUBMITTALS
- A. Section 01330 - Submittal Procedures: Procedures for submittals.
1. Product Data: Manufacturer's technical information and installation instructions for the materials required.
  2. Shop Drawings: Layout drawings and details for proper installation of the work.
  3. Samples:
    - a. Initial Selection:
      - 1) Manufacturer's color charts of actual tiles or sections of tile showing the full range of colors, textures and patterns available for each type of tile indicated.
      - 2) Grout and accessories requiring color selection.
    - b. Final Selection:
      - 1) Full size samples of each type of tile and each color and texture selected.
      - 2) Full size samples of each type of trim, accessory, and for each color.
      - 3) Marble thresholds, 6" long.
      - 4) Stair tread and nosing, full size.
      - 5) Metal edge strip, 6" long.
    4. Mock up:
      - a. Waterproof membrane.
      - b. 30 SF of tile for pattern and joint width conformation.
      - c. Expansion and control joints and metal edge strip installations.
    5. Assurance / Control Submittals:
      - a. Manufacturer's certificate that the products meet or exceed the specified requirements.
- B. Section 01780 - Closeout Submittals: Procedures for closeout submittals.
1. Extra Products: Provide extra products as specified herein below.
- 1.5 COORDINATION
- A. Pre-Installation Meeting: Convene a Pre-Installation Meeting at the Project Site prior to beginning the work of this Section.
1. Require attendance of the Contractor, Owner's representative, Architect, and all impacted trades.
  2. Review coordination and environmental controls required for proper installation and ambient conditions in the areas to receive tile work.
  3. Review preparation and installation procedures, and the coordination and scheduling required with the related work.
- 1.6 QUALITY ASSURANCE
- A. Qualifications:
1. Manufacturer: Company specializing in manufacturing the products specified with a minimum of five (5) years documented experience.
  2. Installer: Company experienced in performing the work of this Section with a minimum of five (5) years documented experience.
- B. Provide materials from a single source for each type and color of tile, grout, setting material and accessory.
- 1.7 DELIVERY, STORAGE AND HANDLING
- A. Section 01600 - Product Requirements: Transport, handle, store, and protect the products.
- B. Deliver tile and setting material to the Project Site in the manufacturer's original, unopened cartons, bearing the name of the manufacturer, the certification mark of the Tile Council of America, and ready for use.
- C. Store materials under cover in a manner to prevent damage and contamination.
- D. Prevent damage and contamination of materials by water, foreign matter and other causes.
- 1.8 JOB CONDITIONS
- A. Environmental Requirements:
1. Maintain adequate lighting for the installation of tile work. Lighting level shall be equal to permanent lighting level designed for areas receiving the tile work.
  2. Maintain sufficient ventilation in areas where the work of this Section is being performed to allow the ceramic tile to properly set.
- b. Documentation of experience indicating compliance with the specified qualifications requirements.

TILE

09300-3

TILE

09300-4

3. Maintain environmental conditions and protect the work during and after installation to comply with the referenced standards and the manufacturer's printed recommendations.

#### 1.9 MAINTENANCE

- A. Section 01780 - Closeout Submittals: Procedures for closeout submittals.
- B. Extra Products: Upon completion of the installation, deliver to the Owner's representative, replacement materials from the same production run as the installed materials; 2% of the total amount of each size, style and color.

#### PART 2 PRODUCTS

##### 2.1 GENERAL

- A. ANSI Standard For Ceramic Tile: Comply with ANSI A137.1 for the types and grades of tile indicated.
- B. ANSI Standard For Tile Installation Materials: Comply with the ANSI Standard referenced with the installation products and materials indicated.
- C. Colors, Texture and Patterns: For tile and other products requiring the selection of colors, surface textures and other appearance characteristics, provide products to match the characteristics indicated or, if not otherwise indicated, as selected from the manufacturer's standards.
- D. Mounting:
  1. Where factory-mounted tile is required, provide back or edge mounted tile assemblies as standard with the manufacturer, unless another mounting method is indicated.
  2. Where tile is indicated for installation in pools, fountains or at exterior or in wet areas, do not use back or edge mounted tile assemblies unless the tile manufacturer specifies that such type of mounting is suitable for that kind of use and has been successfully used on other projects.
- E. Trim Units: Provide tile trim units to match the characteristics of the adjoining flat tile and to comply with the following requirements:
  1. Size: As indicated, coordinate with the sizes and coursing of the adjoining flat tiles, where applicable.
  2. Shapes: As follows, selected from the manufacturer's standard shapes:
    - a. Base for Portland Cement Mortar Installations: Coved.
    - b. Base for Thinset Mortar Installations: Coved.
    - c. Wainscot Cap for Thinset Mortar Installations: Surface bullnose.
    - d. External Corners for Thinset Installations: Surface bullnose.
    - e. Internal Corners: Internal cove with cap angle designed to member with

TILE 09300-5

the stretcher shapes.

- f. Stair tread with nosing.

- F. Coefficient of Friction (COF): ADAAG recommends a 0.6 or higher coefficient or higher in dry conditions to meet ADAAG requirements. Typically the COF is indicated in a wet and a dry number under those conditions for the average of the test results. In a situation where there is a potential for water, the tile should meet the COF of 0.6 or higher under wet conditions. ADAAG recommendation for COF on a ramped surface is 0.8. Static coefficient of friction tests are performed according to ASTM C 1028.

##### 2.2 MANUFACTURERS

- A. Subject to compliance with the Project requirements, manufacturer's offering products which may be incorporated into the work include the following:

1. Tile:
  - a. American Olean.
  - b. Dal-Tile Corp.
  - c. Crossville Inc.
2. Mortar and Grout:
  - a. Hydromont by Bostik.
  - b. LATICRETE.
  - c. MAPEI Corp.
3. Latex-Portland Cement Mortar and Grout:
  - a. ProSpec (formerly Bonsal).
  - b. Hydromont by Bostik.
  - c. LATICRETE.
  - d. Summitville Tiles, Inc.

- B. Section 01600 - Product Requirements: Product Options: Substitutions permitted.

##### 2.3 TILE, GENERAL

- A. Tile: ANSI A137.1.
  1. Stain Resistance, CTI Stain Test: Unstainable.
  2. Surface Water Absorption, ASTM C 373: 0.5% Max.
  3. Abrasive Wear, ASTM C 501: 100.
  4. Breaking Strength, ASTM C 648: 250 lbs.

TILE 09300-6

5. Bond Strength, ASTM C 482: 50 psi.
  6. Facial Dimension (range), ASTM C 499: 1.5% Max.
  7. Range of Thickness, ASTM C 499: 0.04" Max.
  8. Warpage (Diagonal), ASTM C 485:  $\leq 0.75\%$  Max.
  9. Wedging, ASTM C 502: 1% Max.
  10. Chemical Resistance, ASTM C 650: Unaffected.
  11. Coefficient of Friction, ASTM C 1028:
    - a. Dry  $> 0.7$ .
    - b. Wet  $> 0.6$ .
  12. Scratch Hardness, Moh's Scale:  $\geq 8$ .
- 2.4 QUARRY TILE
- A. Dal-Tile, quarry tile, 4" x 8", or size and shape as selected.
  - B. Color as selected.
- 2.5 CERAMIC TILE
- A. American Olean, 2" x 2", ceramic mosaic floor tile.
  - B. American Olean, 4" x 4", ceramic glazed wall tile.
  - C. Color as selected. Accent tile shall be a contrasting color to the field tile color.
- 2.6 PORCELAIN TILE.
- A. 20" x 20" or size and shape as selected, glazed floor tile by Dal-Tile.
  - B. 6" x 6" or as indicated unglazed floor tile at the exterior by Dal-Tile.
  - C. Color as selected.
    1. Accent tiles shall be a contrasting color to the field tile color.
- 2.7 MARBLE THRESHOLD
- A. Alabama Marble Tile Co., Inc.
  - B. Dal-Tile.
  - C. Thornton Tile and Marble, Inc.
  - D. Size, shape and color as shown, or as selected.
  - E. Section 01600 - Product Requirements: Product Options: Substitutions permitted.

TILE

09300-7

2.8 WATERPROOF MEMBRANE

- A. Liquid Applied Membrane: Thin, load-bearing, flexible waterproofing system, self-curing liquid rubber polymer, cold-applied with integral reinforcing fabric to form a seamless membrane.
- B. LATICRETE #9235 Waterproofing Membrane by LATICRETE or approved equal.

2.9 MISCELLANEOUS MATERIALS

- A. Metal Edge Strip: Brass or stainless steel, as selected; 1/8" wide at the top edge with integral provision for anchorage to mortar bed or substrate, unless otherwise indicated. Style to be as indicated, or appropriate to the use; as manufactured by Schluter Systems, or approved equal. Style to be as appropriate for the use intended
  - B. Wall Access Panel: Schluter-REMA by Schluter Systems or approved equal.
  - C. Adhesives: Water-resistant organic; ANSI A136.1.
  - D. Water: Clean and potable.
  - E. Reinforcing Mesh: 2" x 2", 16 gauge, galvanized, welded wire.
  - F. Tile / Grout Sealer: Non-flammable, water-soluble, penetrating methyl silicone clear solution, stain-resistant, matte sealer.
  - G. Tile, Grout and Masonry Cleaner: As approved by the tile, grout and sealer manufacturers.
- 2.10 MORTAR AND GROUT MIX
- A. Mix and proportion mortar and grout materials in strict accordance with the manufacturer's instructions.

PART 3 EXECUTION

3.1 EXAMINATION

- A. Section 01700 - Execution Requirements: Verification of existing conditions before starting the work.
- B. Verification of Conditions: Verify that field measurements, surfaces, substrates slope to drains and conditions are as required, and ready to receive the work.
  1. Examine areas to be covered for surface contamination which requires correction before work begins.
- C. Report in writing, prevailing conditions that will adversely affect satisfactory execution of the work of this Section. Do not proceed with the work until the unsatisfactory conditions have been corrected.

3.2 PREPARATION

- A. Do not use sealers or curing compounds on concrete slabs to be covered with tile. Slabs shall be covered and wet cured for a minimum of seven (7) days. Surfaces to receive tile

TILE

09300-8

- installed by the thin set method shall have a wood float finish, be true to within 1/8" in 10 feet, and pitched to drains where required.
- B. Areas requiring fill, patching or leveling shall be prepared by the General Contractor. Do not use gypsum or asphalt leveling compounds.
  - C. Seal substrate surface cracks with filler.
  - D. Clean substrate surfaces to remove dust, dirt, mortar, etc.
  - E. Surfaces to be covered shall be left clean, free of dust, plaster, sealer or curing compounds and form oil. Any such contamination shall be removed by the responsible trade.
  - F. Prepare substrate surfaces for adhesive installation in accordance with adhesive manufacturer's instructions.
  - G. Protect surrounding work from damage or disfiguration.
  - H. Vacuum clean existing substrate and damp clean.
  - I. Wet down or wash and remove excess water from dry or dusty concrete or masonry surfaces just prior to the application of pavers.

### 3.3 INSTALLATION

- A. Installation Methods: Install ceramic tile in accordance with the TCA, <sup>3</sup>A Handbook for Ceramic Tile Installation<sup>®</sup>, ANSI A108.4, and ANSI A108.5.
- B. Waterproof Membrane: Install waterproof membrane for all elevated slab floors exposed to water or wind blown rain. For example, install at elevated slabs where Showers, Baths, Kitchens, washing and other wet activities occur, and at terraces and roofs over interior spaces.
  1. Contractor shall obtain architect or owner's representative approval of membrane prior to proceeding with the work.
- C. Installation by Thick Bed Method:
  1. Spread mortar to approximately one-half the desired bed thickness, then place reinforcing mesh. Lap mesh 3", minimum, and place additional mortar over the mesh to bring the bed to the desired thickness. Rod and compact mortar with a steel trowel. The setting bed shall be, minimum, 1-1/2" thick.
    - a. Note: The setting bed may be reduced to a nominal 1" thickness and the reinforcing omitted when bonding directly to concrete slabs or a load-bearing membrane.
  2. Before placing tile on a green or wet screed bed, apply a slurry of bond coat to the mortar bed using a flat trowel.
  3. Tile shall be placed in the wet slurry coat before the surface dries, or apply a slurry bond coat applied to the back of each tile just prior to placing the tile on the bed.
  4. Before the mortar takes initial set, place and beat each tile into place with a wooden block or rubber mallet to embed it and to even the surface.

TILE

09300-9

5. Maintain uniform joint widths.
  6. The surface shall be pitched to drains, where indicated, or as required.
  7. On hardened screed or mortar bed, tiles may be installed by the thin set method if proper tolerances are provided.
- D. Installation by Thin Set Method:
1. Apply mortar with a notched trowel using a scraping motion to work the material into good contact with the substrate to be covered. A trowel having notches approximately 1/4" x 3/8" is recommended for pavers. Apply only as much mortar as can be covered within 30 minutes, or while the surface is still tacky.
  2. Trowel a small quantity of mortar onto the back of each piece of tile. Set the tile in place and tap with a small beating block to ensure 100% full bedding and a true surface.
  3. Align tile to provide uniform joints and then allow to set until firm.
  4. Clean excess mortar from the surface of tiles with a wet cloth or sponge while the mortar is still fresh.

### E. Mortar:

1. Machine Mixing: Mortar mixer shall be the rotating blade type. Place mixing liquid in the mixer, start the machine and add sand, then cement. Mix only long enough to wet out the batch. Stop the mixer and dump the mortar promptly. Do not overmix.
2. Hand Mixing: Pre-mix the dry ingredients (sand and cement). Place mixing liquid in a clean container or mixing box, add the dry materials and mix. Adjust the amount of liquid or dry materials to obtain the proper consistency.

### F. Joints: 1/8" width for tiles less than 12", 3/16" for tiles to 25"; 1/4" for quarry tile.

### G. Expansion and Control Joints:

1. Existing joints in concrete subfloors must be carried through the tile and shall conform to the architectural details.
2. Expansion joints shall be installed where tile abuts restraining surfaces, such as perimeter walls, curbs, columns, corners, etc.
3. Interior installations shall have expansion joints spaced a maximum of 30 feet o.c. in both directions. Exterior areas shall have expansion joints spaced a maximum of 15' in both directions. Expansion joints shall be raked out or cut through the setting bed to the supporting slab or structure below.

### H. Edge Strips: Install at transitions to other flooring materials, for control joints, or as indicated.

### I. Grouting and Pointing Joints:

1. Joints shall be grouted or pointed with Latex-Portland Cement Grout or Epoxy Grout.

TILE

09300-10



- 2. Joints shall be packed full and free of voids and pits. Tool or rake as specified.
  - 3. Excess mortar shall be cleaned from the surface of tiles with water and a damp sponge as the work progresses, while the mortar is fresh and before it hardens.
- J. Provide a slope in tile setting material as required to slope surfaces at floor transitions and floor drains.
- K. Lay tile to the pattern indicated. Do not interrupt the tile pattern through wall openings.
- L. Cut and fit tile to penetrations through the tile leaving a sealant joint space. Form corners and bases neatly. Align floor, base, and wall joints.
- M. Place tile joints uniform in width, subject to variance in the tolerance allowed in the tile size. Make joints watertight, without voids, cracks, excess mortar or excess grout.
- N. Sound the tile after setting. Replace hollow sounding units.
- O. Expansion, Contraction, Control Joints and Separation: Install tile and a pair of metal edge strips in accordance with the applicable TCA Handbook methods. Keep joints free of adhesive, mortar, and grout, seal. Refer to Section 07900 - Joint Sealers.
- P. Allow tile to set for a minimum of 48 hours prior to grouting.
- Q. Grout tile joints in accordance with ANSI A108.10.
- R. Caulk plumbing penetrations thru floor tiles and plumbing and electrical penetrations thru wall tiles.
- S. Apply sealant to the junction of tile and dissimilar materials and at the junction of dissimilar planes as specified in Section 07900 - Joint Sealers. Apply in strict accordance with the manufacturer's instructions.
- T. Install metal edge strips at transitions to other flooring materials, and where tile edges are exposed. Lock solidly into the setting bed.

### 3.4 INSTALLATION SCHEDULE

- A. Paver Tiles: Install by thick (mortar) bed method. Place waterproof membrane under exterior pavers with occupiable space below. Apply sealer per manufacturer's instructions.
- B. Quarry Tiles: Install by thin set on hardened thick bed method at Freezer floors; thick bed method at Kitchens, thin set at Bars. Place waterproof membrane at Dishwashing, garbage areas and exterior spaces over structural slabs and other wet areas.
- C. Ceramic Tiles: Install by thin set or thick (mortar) bed method. Place waterproofing membrane at Baths, Shower Rooms, areas on structural slabs subject to wind blown water and other wet areas.

### 3.5 TOLERANCE

- A. Maintain an even and flat plane with variation not to exceed 1/8" in 8 feet. Adjacent tile shall be flush with no protruding or recessed tile edges. The tiles shall be cut neatly and fit to built-in work, penetrations, corners, changes in elevations and other variations.

TILE

09300-11

### 3.6 FIELD QUALITY CONTROL

- A. Section 01450 - Quality Control: Field inspection.
- B. Inspect installations for joint widths, alignment, edge treatments, sound bonding to the substrates.

### 3.7 CLEANING

- A. Section 01700 - Execution Requirements: Cleaning the installed work.
- B. Upon the completion of placement and grouting, clean all ceramic tile surfaces free of foreign matter.
- C. Remove excess mortar and grout from floor, base, and wall surfaces without damaging the surfaces.
- D. Clean unglazed tiles with acid solutions only when permitted by the tile and grout manufacturer's printed instructions, but not sooner than fourteen (14) days after installation. Protect metal surfaces, cast iron and vitreous plumbing fixtures from the effects of acid cleaning. Flush surfaces with clean water before and after cleaning.
- E. Clean tile only with cleaning materials recommended by tile and grout manufacturers.
- F. Remove hardened grout film or haze using Laticrete TC-500, Grout and Masonry Cleaner.
  - 1. Saturate grout joints with water, then dampen the surface with the cleaner.
  - 2. Allow to soak 15 - 30 minutes and then use a power scrubbing machine with a coarse texture nylon pad to remove the grout film.
- G. Clean unglazed pavers by sprinkling fine sand (30 - 60 mesh) over the surface before scrubbing.
  - 1. Caution: Do not use sand on soft glazed tiles.
- H. Do not use acid type cleaners on colored grout joints.
- I. Leave finished installations clean and free of cracked, chipped, broken, un-bonded and otherwise defective work.

### 3.8 PROTECTION

- A. When recommended by the tile manufacturer, apply a protective coat of neutral protective cleaner to the completed floor and wall tiles.
- B. Protect installed tile work with kraft paper or other heavy covering to prevent staining, damage and wear.
- C. Prohibit foot and wheel traffic from tiled floors for at least seven (7) days after grouting has been completed.
- D. Immediately before final inspection, remove the protective coverings and rinse the neutral cleaner from the tile surfaces.

TILE

09300-12

E. Before final inspection, remove protective coverings and rinse neutral cleaner from the tile surfaces.

SECTION 09650  
RESILIENT FLOORING

END OF SECTION

PART 1 GENERAL

1.1 SUMMARY

A. Section Includes:

1. Vinyl composition tile.
2. Sheet vinyl flooring.
3. Resilient edge strip.
4. Rubber base.
5. Accessories.

B. Related Documents: The Contract Documents, as defined in Section 01010 - Summary of Work, apply to the work of this Section. Additional requirements and information necessary to complete the work of this Section may be found in other Documents.

C. Related Sections:

1. Section 03300 - Cast-In-Place Concrete: Substrate for resilient flooring.
2. Section 09250 - Gypsum Board: Substrate for rubber base.
3. Section 09680 - Carpet: Floor finish for rubber base.

1.2 DESCRIPTION OF WORK

A. The extent of resilient flooring work is indicated on the Drawings and Schedule and as specified herein, and includes providing and installing adhesively applied vinyl composition tile, sheet vinyl flooring, resilient edge strips, rubber base and resilient accessories.

1.3 REFERENCES

A. The publications listed below form a part of this Specification to the extent referenced. Publications are referred to in the text by basic designation only.

B. American Society for Testing and Materials (ASTM):

1. ASTM E 648 - Test Method for Critical Radiant Flux of Floor-Covering Systems Using a Radiant Heat Energy Source.
2. ASTM E 662 - Test Method for Specific Optical Density of Smoke Generated by Solid Materials.
3. ASTM F 1066 - Specification for Vinyl Composition Floor Tile.
4. ASTM F 1303 - Specification for Sheet Vinyl Floor Covering with Backing.
5. ASTM F 1861 - Specification for Resilient Wall Base.

09300-13

RESILIENT FLOORING

09650-1

TILE

1.4 SUBMITTALS

- A. Section 01330 - Submittal Procedures: Procedures for submittals.
  - 1. Product Data: Technical data and installation instructions for each type of resilient flooring and accessory.
    - a. Two boxes - 2" x 2" samples of each type, color and pattern in the specified group of the manufacturer selected for each type of resilient flooring required.
    - b. 12" x 12" samples of sheet flooring.
    - c. Samples of available colors for resilient edge strip.
    - d. One chain of available colors for rubber base selection.
  - 3. Final Samples: Submit for final selection.
    - a. 2 - full-size samples of vinyl tile.
    - b. 2 - 12" x 12" samples of sheet flooring.
    - c. 2 - 6" long sections of resilient edge strip.
    - d. 2 - 6" long sections of rubber base.
  - 4. Assurance / Control Submittals:
    - a. Manufacturer's certificate that the products meet or exceed the specified requirements.
    - b. Documentation of experience indicating compliance with the specified qualifications requirements.
  - 5. Maintenance Instructions: Submit two (2) copies of the manufacturer's recommended maintenance practices for each type of resilient flooring and accessory required.

1.5 QUALITY ASSURANCE

- A. Qualifications:
  - 1. Manufacturer: Company specializing in manufacturing the products specified with a minimum of five (5) years documented experience.
  - 2. Installer: Company experienced in performing the work of this Section with a minimum of five (5) years documented experience.
- B. Regulatory Requirements:
  - 1. Critical Radiant Flux in Accordance with ASTM E 648: More than 0.45 watts per square centimeter.
  - 2. Specific Optical Smoke Density in Accordance with ASTM E 662: Less than 450.
- C. Where possible, provide each type of resilient flooring and accessories as the products of a single manufacturer, including recommended primers, adhesives, and sealants.

RESILIENT FLOORING

09650-2

1.6

DELIVERY, STORAGE AND HANDLING

- A. Section 01600 - Product Requirements: Transport, handle, store and protect the products.
- B. Deliver products to the Project Site in the manufacturer's original, unopened cartons and containers, each bearing the name of the product and manufacturer, project identification, and shipping and handling instructions.
- C. Store the materials in a dry space, protected from the weather, with ambient temperatures maintained between 50 degrees and 90 degrees F.
- D. Store on a flat surface.

1.7

JOB CONDITIONS

- A. Environmental Requirements:
  - 1. Do not install flooring over concrete slabs until the slabs have been cured and are sufficiently dry to achieve bond with the adhesive, as determined by the manufacturer's recommended bond and moisture tests.
  - 2. Store materials in the area of installation for at least 48 hours prior to beginning installation.
  - 3. Maintain the ambient temperature required by the adhesive manufacturer, not less than 72 degrees F, for three days prior to, during, and for 48 hours after installation.
  - 4. Install flooring and accessories only after other finishing operations, including painting, have been completed.
  - 5. Provide adequate temporary ventilation during installation.

1.8

MAINTENANCE

- A. Section 01780 - Closeout Submittals: Procedures for closeout submittals.
- B. Extra Materials: At completion of the installation deliver to the Project Site extra materials from the same manufactured lot as the materials installed in the following quantities:
  - 1. Not less than 2% of each type, size and color of flooring.
  - 2. Not less than 2% of each type and color of base.
  - 3. Submittal of extra accent tiles is not necessary.
- C. Maintenance Data: Submit two (2) copies of manufacturer's recommended maintenance practices for each type of flooring and accessory required, recommended maintenance materials and suggested schedule for cleaning.

PART 2 PRODUCTS

2.1

MANUFACTURERS

- A. Subject to compliance with the Project requirements, manufacturers offering the specified items which may be incorporated into the work include the following:
  - 1. Tile:

RESILIENT FLOORING

09650-3

- a. Armstrong Floor Products (Armstrong World Industries, Inc.).
  - b. Azrock.
  - c. Tarkett.
2. Sheet Vinyl:
- a. Armstrong Floor Products (Armstrong World Industries, Inc.).
  - b. Azrock.
  - c. Tarkett.
3. Resilient Edge Strip:
- a. Armstrong Floor Products.
  - c. Roppe.
  - d. Burke Mercer.
4. Rubber Base:
- a. Armstrong Floor Products.
  - b. Roppe.
  - c. Burke Mercer.
- B. Colors, patterns and sizes shall be selected from the manufacturer's standards.
- C. Section 01600 - Product Requirements: Product Options: Substitutions permitted.

2.2 MATERIALS

- A. Vinyl Composition Tile: 12" x 12" x 1/8" gauge composition tile; resistant to alkali, grease and oils and able to withstand static loads of 125 psi; ASTM F 1066, marbled design as follows:

- 1. (VCT-1):
  - a. Standard Excelon, Imperial Texture by Armstrong.
  - b. Cortina Colors & Classics by Azrock.
  - c. Standard, Expressions by Tarkett.
- 2. (VCT-2):
  - a. Standard Excelon, Imperial Texture by Armstrong.
  - b. Cortina Colors & Classics by Azrock.
  - c. Standard, Expressions by Tarkett.
- 3. Color: As selected. Accent tile (VCT-2) shall be a color contrasting with the field tile color.

RESILIENT FLOORING 09650-4

- B. Sheet Vinyl Flooring (SV-1): Randomly placed, high-contrast colors to create a terrazzo-like pattern; ASTM F 1303 Class A backing, Grade 1, Type II, flexible fiberglass; 6 feet wide; nominal 0.060A overall gage, 0.050" nominal wear layer, modified static load limit 500 psi, as follows:
- 1. Connection Corlon by Armstrong.
  - 2. Section 01600 - Product Requirements: Product Options: Substitutions permitted.
- C. Resilient Edge Strip: Homogeneous vinyl, tapered or bullnose edge, 1/8" thick x not less than 1" wide x length required or roll length. Color as selected.
- D. Rubber Base (RB-1): Type TP, [4"] [6"] high, 1/8" thick, topset; standard coved toe at resilient flooring, toeless at carpet; matching end stops and preformed corner units; roll length; ASTM F 1861. Color as selected.

2.3 ACCESSORIES

- A. Subfloor Filler: Latex underlayment mixed with undiluted latex liquid, furnished by or as recommended by the resilient flooring manufacturer as follows:
- 1. Leveler I by Dayton Superior Corporation.
  - 2. No. 345 by W.W. Henry Company.
  - 3. Section 01600 - Product Requirements: Product Options: Substitutions permitted.
- B. Concrete Slab Primer: Non-staining type as recommended by the resilient flooring manufacturer.
- C. Adhesive: As recommended by the resilient flooring manufacturer for the specific material and substrate conditions; clear color.

PART 3 EXECUTION

3.1 EXAMINATION

- A. Section 01700 - Execution Requirements: Verification of existing conditions before starting the work.
- B. Verification of Conditions: Verify that field measurements, surfaces, substrates and conditions are as required, and ready to receive the work.
- C. Report, in writing, prevailing conditions that will adversely affect satisfactory execution of the work of this Section. Do not proceed with the work until the unsatisfactory conditions have been corrected.
- D. Start of the flooring installation shall indicate acceptance of the subfloor conditions and full responsibility for the completed work.

3.2 PREPARATION

- A. Prepare the substrate for product installation in accordance with the manufacturer's published instructions.

RESILIENT FLOORING

09650-5

CENTRAL POLICE PRECINCT

- B. Remove existing floor finishes and prepare substrate as recommended by the resilient flooring manufacturer.
- C. Remove curing compounds not compatible with the adhesive. Avoid organic solvents.
- D. Remove ridges, bumps and other irregularities in the substrate.
- E. Fill cracks, joints, holes and depressions with a subfloor filler and leveler recommended by the flooring manufacturer to achieve a smooth, flat, hard surface, with no more than 1/8" variation from plane within 10 feet in any direction.
- F. Prohibit traffic until the filler has cured.
- G. Broom clean and vacuum surfaces to be covered by resilient flooring; inspect the subfloor.
- H. Perform bond and moisture tests on concrete slabs to determine that concrete surfaces are sufficiently cured, dried and are ready to receive the flooring. Utilize a bond test recommended by the flooring manufacturer. Ensure that moisture content of the concrete substrate does not exceed 3% as measured by the Calcium Carbide Hygrometer Procedure or 5% by normal Proimeter.
- I. If bond test is negative, surface the existing floor with latex underlayment as recommended by the manufacturer.
- J. Apply concrete slab primer, if recommended by the flooring manufacturer, prior to the application of adhesive. Apply in compliance with the manufacturer's instructions.
- 3.3 INSTALLATION - GENERAL
- A. Install resilient flooring using the methods indicated, and in strict compliance with the manufacturer's recommendations.
- B. Maintain subfloor reference marks, penetrations, and openings that are in place or plainly marked for future cutting by repeating on the finished flooring. Use chalk or other non-permanent marking device.
- C. Cut flooring to and fit around all permanent fixtures, built-in furniture, cabinets, pipes, and outlets. Cut edges, and fit and scribe to walls and partitions after the field flooring has been installed.
- D. Extend flooring into toe spaces, door rabbets, closets and similar openings.
- E. Tightly cement flooring to the subbase without open cracks, voids, raising and puckering at joints, telegraphing of adhesive spreader marks, or other surface imperfections.
- F. Install flooring on covers for telephone and electrical ducts, and other such items that occur within finished floor areas; maintain overall continuity of colors and patterns with pieces of flooring installed in the covers. Tightly cement edges to the perimeter of the floor around the covers and to the covers.
- 3.4 INSTALLATION - VINYL COMPOSITION TILE FLOORING
- A. Install the resilient tile flooring in accordance with the manufacturer's published instructions.

RESILIENT FLOORING 09650-6

- B. Prime concrete slabs in contact with the ground with cut-back type primer as recommended by the flooring manufacturer. Work the primer with a non-absorptive base completely into the surface. Primer shall be thoroughly dry before applying adhesive.
- C. Apply adhesive in accordance with the adhesive manufacturer's printed directions, unless specified or directed otherwise. Apply only cut-back adhesive to primed concrete surfaces.
- D. Spread only enough adhesive to permit the installation of floor materials before initial set.
- E. Open only the number of floor tile cartons for the quantity of material required to cover each area. Mix tile pieces to ensure that noticeable shade variations do not occur within any one area.
- F. Install tile flooring in a checker board pattern, or as indicated. Start in the center of the room or area and work from the center towards the edges. Vary edge width as necessary to maintain full-size tiles in the field, but no edge tile shall be less than 1/2 the field tile size, except where irregular shaped rooms or conditions make it impossible. Keep tile lines and joints square, symmetrical, tight, and even; keep each floor in a true, level plane, except where indicated as sloped.
- G. Locate accent tiles where shown, or if not shown locate per Architect's instructions.
- H. Scribe flooring to walls, columns, cabinets, floor outlets, and other appurtenances accurately for tight joints.
- I. Where flooring continues through a wall opening, continue the established pattern without interruption. One row of tiles may be cut to less than full size, if necessary, to establish the pattern in the adjoining room.
- J. Where an adjacent floor finish is dissimilar, terminate the resilient flooring at the centerline of openings or centerline of doors in the closed position.
- K. Press installed flooring with a 150 pound resilient flooring roller to attain full adhesion.
- 3.5 INSTALLATION - SHEET VINYL FLOORING
- A. Layout sheet flooring for as few seams as possible with economical use of materials.
- B. Match edges for color, pattern and shading at seams in compliance with the manufacturer's recommendations.
- C. Prepare seams in the sheet flooring in accordance with the manufacturer's instructions for the most inconspicuous appearance. Seal continuously with fluid applied sealant or adhesive as standard with the manufacturer.
- D. Adhere sheet flooring to the substrate using a method approved by the flooring manufacturer for the type of sheet flooring and substrate conditions.
- E. Use conventional perimeter bonding adhesive procedures where recommended by the flooring manufacturer. Use special perimeter bonding adhesive for unfilled vinyl sheet with vinyl backing.
- 3.6 INSTALLATION - RESILIENT EDGE STRIP
- A. Install edge strips at unprotected and exposed edges where resilient flooring terminates and where flooring terminates at points higher than the contiguous finished flooring, except at doorways where thresholds are located.

RESILIENT FLOORING 09650-7

SECTION 09900  
PAINTING

B. Place resilient edge strips tightly butted to the resilient flooring. Secure with adhesive to the flooring and substrate.

3.7 INSTALLATION - RUBBER BASE

- A. Install rubber base in accordance with the manufacturer's published instructions.
- B. Apply rubber base to walls, columns, pilasters, casework and other permanent fixtures in rooms or areas where base is required. Install the base in lengths as long as practicable. Maintain a minimum measurement of 18" between joints. Install true to line, level and with tight vertical joints. Scribe and fit accurately to and around permanent fixtures, equipment and bases.
- C. Use preformed units at external corners and exposed ends. Miter or cope inside corners.
- D. Install on solid backing; firmly adhere to walls, floor surfaces and permanent fixtures, except carpet throughout the length of each piece, with continuous contact at horizontal and vertical surfaces.
- E. On masonry surfaces, or other similar irregular surfaces, fill voids along the top edge of wall base with the manufacturer's recommended adhesive filler material.
- F. Roll the installation per the manufacturer's instructions.

3.8 FIELD QUALITY CONTROL

- A. Section 01450 - Quality Control: Field inspection.
- B. Inspect the resilient flooring and base installation, pattern, layout and attachment to the substrate.

3.9 CLEANING

- A. Section 01700 - Execution Requirements: Cleaning the installed work.
- B. Remove excess adhesive and other surface blemishes from the floor finish, base and wall surfaces without damage; use neutral type cleaners recommended by the flooring manufacturer.
- C. Just prior to final inspection, thoroughly clean the flooring, edge trims and base.
- D. Apply polish and buff. Use the type of polish, number of coats, and buffing procedures in compliance with the flooring manufacturer's instructions.

3.10 PROTECTION

- A. Protect installed flooring with heavy Kraft paper or other covering until final acceptance inspection.

END OF SECTION

RESILIENT FLOORING 09650-8

PART 1 GENERAL

1.1 SUMMARY

- A. Section Includes:
  - 1. Interior and exterior paint systems.
  - 2. Schedule of Items to be painted.
  - 3. Painting Treatments Schedule.
- B. Related Documents: The Contract Documents, as defined in Section 01010 - Summary of Work, apply to the work of this Section. Additional requirements and information necessary to complete the work of this Section may be found in other Documents.

1.2 DESCRIPTION OF WORK

- A. The extent of the work of this Section is indicated on the Drawings and Schedules and as specified herein, complete, and includes cleaning and preparation of all interior and exterior surfaces to be painted or finished, and finishing of all interior and exterior surfaces, unless hereinafter excluded.

1.3 REFERENCES

- A. The publications listed below form a part of this Specification to the extent referenced. Publications are referred to in the text by basic designation only.
- B. American Society for Testing and Materials (ASTM):
  - 1. ASTM E 84 - Test Method for Surface Burning Characteristics of Building Materials.

1.4 GENERAL

- A. The term "Paint" as used herein, means all coating systems materials, including primers, emulsions, enamels, stains, sealers and fillers, and other applied materials whether used as primer, intermediate coat or finish coat.
- B. The following categories of work are included under other Sections of these Specifications:
  - 1. Shop Priming: Unless otherwise specified, shop priming of ferrous metal items is included under various Sections of structural steel, metal fabrications, hollow metal doors and frames, and similar items.
  - 2. Unless otherwise specified, shop priming of fabricated components such as architectural woodwork, wood casework and shop-fabricated or factory-built mechanical and electrical equipment or accessories is included under other Sections.

1.5 SUBMITTALS

PAINTING 09900-1

representatives of the paint subcontractor and other finish products, and the mechanical and electrical trades.

2. Review coordination and environmental controls required for the proper application and ambient conditions in the areas to receive paint.
3. Review preparation and installation procedures, and the coordination and scheduling required with the painting work.

#### 1.7 QUALITY ASSURANCE

##### A. Qualifications:

1. **Manufacturer:** Company specializing in manufacturing the products specified with a minimum of five (5) years documented experience.
2. **Applicator:** Company experienced in performing the work of this Section with a minimum of five (5) years documented experience.

##### B. Regulatory Requirements:

1. **Surface Burning Characteristics in Accordance with ASTM E 84 for Class I or A finish:**
  - a. **Flame Spread (Non-Combustible Surfaces):** Less than 25.
  - b. **Smoke Density (Non-Combustible Surfaces):** Less than 450.
2. Provide paint and coating materials that conform to Federal, and local Government restrictions for volatile organic compounds (VOC) content.

**C. Codes and Standards:** The work and materials shall conform to regulations of the Fire Department, safety color coding in conformance with OSHA and all other regulatory ordinances having jurisdiction. Conform to the most stringent requirements of the authorities having jurisdiction.

**D. Single Source Responsibility:** Provide primers and other undercoat paint products by the same manufacturer as the finish coats. Use only thinners approved by the paint manufacturer, and use only within the recommended limits.

**E. Coordination of Work:** Review other Section of these Specifications in which prime paints are to be provided to ensure compatibility of the total coating system for various substrates. Upon the request of other trades, furnish information or characteristic of the finish materials provided for use, to ensure that compatible prime coats are use.

#### 1.8 DELIVERY, STORAGE AND HANDLING

**A. Section 01600 - Product Requirements:** Transport, handle, store, and protect the products.

**B. Deliver products to the Project Site in the manufacturer's original, new and unopened packages and containers bearing the following information:**

1. Manufacturer's name.
2. Name or title of the material.

PAINTING

09900-3

**A. Section 01300 - Submittal Procedure:** Procedures for submittals.

1. **Product Data:** Submit for each type of paint specified.
  - a. Manufacturer's technical information including paint analysis, and application instructions for each material proposed for use.
  - b. **Painting Schedule** listing the surfaces to be painted with cross reference to the specific painting and finishing system, and application. Identify each paint material by manufacturer's catalog number and general classification.

##### 2. Samples:

a. Prior to beginning the painting work, the Architect will furnish color chips for surfaces to be painted. Use representative colors when preparing samples for review. Submit samples of color and texture only for the Architect's review. Provide a listing of materials and application for each coat of each finish sample.

b. Provide two (2) samples of each color and material on 8" x 12" hardboard, with texture to simulate actual conditions. Re-submit samples as requested by the Architect until acceptable color, sheen, and texture is achieved.

c. Provide two (2) 8" x 12" samples of natural and stained wood finish on actual wood surfaces. Label and identify each as to location and application.

d. Provide two (2) 8" x 12" samples of masonry for each type of finish and color on concrete masonry, showing the filler, prime coat and finish coats.

3. **Mock-Up:** On actual wall surfaces and other interior and exterior building components, duplicate the paint finish of the prepared samples. Provide full-coat finish samples on at least 80 sq. ft. of surface, as directed, until the required color, sheen and texture is obtained; simulate the final lighting conditions for review of the work in-place.

##### 4. Assurance / Control Submittals:

- a. Manufacturer's certificate that the products meet or exceed the specified requirements.
- b. Documentation of experience indicating compliance with the specified qualifications requirements.
- c. Manufacturer's Material Safety Data Sheets (MSDS) for each paint type specified.

#### 1.6 COORDINATION

**A. Pre-Application Meeting:** Convene a Pre-Application Meeting at the Project Site prior to beginning the painting work.

1. Require attendance of the Contractor, Owner's representative, Architect,

PAINTING

09900-2

production run as the materials applied. Provide 2% of each, but not less than one (1) quart, nor more than ten (10) gallons of each type, color and sheen.

2. Label each container with the color, type and texture, in addition to the manufacturer's label.

**PART 2 PRODUCTS**

**2.1 MANUFACTURERS**

A. Subject to compliance with the Project requirements, manufacturers offering products which may be incorporated into the work include the following:

1. Frazee Paint & Wallcovering.
2. Benjamin Moore & Co.
3. Sherwin-Williams Co.
4. Olympic Stains.
5. Watco Co.
6. ZAR by United Gilsonite Laboratories.
7. JASCO.
8. Thoro Systems Products.
9. PPG Amercoat (formerly Ameron Protective Coatings).
10. Textured Coatings of America, Inc. (TEX-COTE).
11. Rain Products Company.

B. Section 01600 - Product Requirements: Product Options: Substitutions permitted.

**2.2 MATERIALS**

A. Material Quality:

1. Manufacturer's best quality grade of the various types of coatings, and suitable for the intended purpose, as regularly manufactured by acceptable paint materials manufacturers. Materials not displaying the manufacturer's identification as a standard, best-grade product will not be acceptable.

a. Proprietary names used to designate colors or materials are not intended to imply that the products of the named manufacturers are required to the exclusion of equivalent products by other manufacturers.

B. Color Pigments:

1. Pure, non-fading, applicable types to suit the substrates and service indicated. Manufacturer shall confirm that exterior applied pigments will not fade when exposed to UV light.

3. Manufacturer's lot number and date of manufacture.

4. Contents by volume for major pigment and vehicle constituents.

5. Color name and number.

6. Thinning or reducing instructions.

7. Application instructions including surface preparation and coverage.

8. Drying time.

9. Cleanup requirements.

C. Store products, not in actual use, in tightly covered containers, off the ground and under cover. Maintain containers used in the storage of paint, in a clean condition, free of foreign materials and residue.

D. Store paint materials at a maximum ambient temperature of 90°F, in a ventilated area, and in compliance with the manufacturer's published instructions.

E. Keep storage areas neat and orderly. Remove oily rags and waste daily.

F. Protect against fire hazards and spontaneous combustion.

G. Take all precautions to ensure that workmen and the work areas are adequately protected from health hazards that might result from handling, mixing and application of paints.

**1.9 JOB CONDITIONS**

A. Environmental Requirements:

1. Do not apply paint during rain, fog or mist when the relative humidity exceeds 85%, or to damp or wet surfaces, unless otherwise permitted by the paint manufacturer's printed instructions.

2. Apply paint finishes only when the moisture content of the surfaces to be coated is within the manufacturer's acceptable range for the type of finish to be applied.

3. Painting may be continued during inclement weather if the areas and surfaces to be painted are enclosed and within the humidity limits specified, and allowed by the paint manufacturer's printed instructions.

4. Do not apply paint in areas where dust is being generated.

5. In areas being painted provide a lighting level of, at least 80 foot-candles, measured at mid-height of the surface being painted.

**1.10 MAINTENANCE**

A. Section 01780 - Closeout Submittals: Procedures for closeout submittals.

B. Extra Materials:

1. Upon completion of the work, provide replacement materials from the same

PAINTING

09900-4

PAINTING

09900-5

CENTRAL POLICE PRECINCT



2. All exterior colors and interior deep tone colors shall be ground-in at the factory. Shop mixing is not permitted.
3. Colors to be as selected by the Architect, and subject to modification on the Project Site at the Architect's discretion.
4. Lead content in pigment, if any, is limited to not more than 0.06%, based on the total non-volatile (dry film) of paint by weight. This limitation extends to interior surfaces and those exterior surfaces, such as stairs, decks, porches, railings, windows, and doors which are readily accessible to children.
- C. Paint:
- Ready-mixed pigments fully-ground, maintaining a soft paste consistency, capable of readily and uniformly dispersing to a complete homogeneous mixture.
  - Provide good flowing and brushing properties, and capable of drying or curing free of streaks and sags.
- D. Primers and Undercoaters: Produced by the same manufacturer as the intermediate and finish coats.
- E. Paint Accessory Materials: Linseed oil, shellac, turpentine and other materials not specifically indicated herein, but required to achieve the finishes specified to be of high quality, and by an approved manufacturer.

## 2.3 PAINT SYSTEMS

- A. (EAE) Exterior Acrylic Emulsion: A 100% acrylic latex, water-thinned coating with extra mildewcide, flat finish, #203 Duratec and #266 Epotit acrylic-epoxy sealer by Frazee, or Loxon acrylic primer with A-100, 100% exterior acrylic latex by Sherwin-Williams.
- B. (EAHE) Exterior Acrylic High Build Emulsion: A high-build, heavy-bodied, water-based, acrylic emulsion with 67% solids conforming to Federal Spec # TTC 00555B, paragraph 4.4.7. Thorocoat by Thoro Systems Products, smooth finish. Finish with two (2) coats of Thoroglaze or other sealer recommended by the manufacturer. Primer to be as recommended by the manufacturer for the Project conditions.
- C. (TC) Textured Coating: Tex-Cote XL-70 primer and top coat system by Textured Coatings of America. Texture as selected by the Architect.
- D. (AFE) Interior Acrylic Flat Emulsion Copolymer: 100% acrylic latex, water thinned, washable, velvet flat finish, #002 Majestic by Frazee.
- E. (AEE) Interior Acrylic Eggshell Enamel: 100% acrylic, water thinned, semi-gloss enamel, #022 Lo-Glo by Frazee.
- F. (LOAE) No VOC Interior Acrylic Paint: Envirokote Interior Low Odor, flat, eggshell or semi-gloss as noted, with Envirokote primer by Frazee.
- G. (AREM) Alkyd Resin Enamel for Interior and Exterior Metal: 628 Aro-plate II SG, semi-gloss with 661 metal primer by Frazee.
- H. (AREW) Alkyd Resin Enamel for Exterior Wood: 372 wood undercoat with two coats of 352 Classic House and Trim Gloss Enamel, semi-gloss by Frazee.

PAINTING

09900-6

- I. (EPC) Epoxy Paint for Cementitious Materials: Polyamide epoxy coating system, two-component coating self-priming, semi-gloss, Amerlock 400 by PPG Americoat.
- J. (EPM) Epoxy Paint for Metal: 561 acrylic metal primer with Aro-Gard 542 finish coats, two-component coating, semi-gloss by Frazee. Prepare metal with JASCO Prep and Primer.
- K. (RIP) Rust Inhibitive Primer: Alkyd mineral spirit thinned, satin finish primer, #661 metal prime, rust preventive alkyd primer by Frazee.
- L. (BF) Block Filler: Acrylic block filler; #262 acrylic block filler by Frazee.
- M. (PS) Primer Sealer: PVA vinyl acrylic resin, water-thinned, flat finish primer, #061 Aqua Seal interior PVA Sealer by Frazee.
- N. (PSU) Polyurethane: Clear finish exterior polyurethane varnish, Satin; ZAR #203.
- O. (WS) Wood Stain: Olympic semi-transparent wood stain or ZAR transparent interior stain as selected by the Architect.
- P. (CWF) Clear Wood Finish: Oil alkyd resin, satin or hand rub finish, Deft Clear Wood Finish.
- Q. (DO) Wood Sealer: Watco Danish Oil finish, exterior formula where exposed to wind blown water.
- R. (OS) Concrete Stain: Lithochrome stain in water solution by Scofield Co.
- S. (TEC) Cementitious Sealer: Elasto-grip FC, waterborne modified polyamine epoxy by Thnec.
- T. (TEC) Concrete Coating: Enviro-crete 156, modified waterborne acrylate by Thnec.
- U. (GRC) Graffiti Resistant Coating: Water repellent, clear, deep-penetrating, non-film forming, non yellowing, heavy duty chemical water repellent solution. VandIGuard non-sacrificial graffiti coating system.
- PART 3 EXECUTION
- 3.1 EXAMINATION
- A. Section 01700 - Execution Requirements: Verification of existing conditions before starting the work.
- B. Verification of Conditions: Verify that field measurements, surfaces, substrates and conditions are as required, and ready to receive the work.
- C. Report, in writing, prevailing conditions that will adversely affect satisfactory and timely execution of the work of this Section. State, in writing, any anticipated problems with using the specified coating systems on substrates primed by others. Do not proceed with the work until the unsatisfactory conditions have been corrected in a manner acceptable to the Applicator.
- D. Starting the painting work will be construed as the Applicator's acceptance of the surfaces

PAINTING

09900-7

and condition within any particular area.

### 3.2 SURFACE PREPARATION

- A. Do not paint over dirt, rust, scale, grease, moisture, scuffed surfaces, or conditions otherwise detrimental to the formation of a durable paint film.
- B. Perform preparation and cleaning procedures in accordance with the paint manufacturer's published instructions, and as herein specified, for each substrate condition.
  - 1. Provide barrier coats over incompatible primers, or remove and reprime as necessary.
  - 2. Remove hardware, hardware accessories, machined surfaces, plates, lighting fixtures, and similar items in place and not to be field painted, or provide surface-applied protection prior to surface preparation and painting operations. Remove, if necessary, for complete painting of items and adjacent surfaces. Following completion of the painting of each space or area, reinstall all removed items.
  - 3. Clean surfaces to be painted before applying paint or surface treatment. Remove any oil or grease prior to mechanical cleaning.
  - 4. Program cleaning and painting so contaminants from the cleaning process do not fall onto wet, newly painted surfaces.

C. Ferrous Metals: Clean ferrous surfaces not galvanized or shop-coated of oil, grease, dirt, loose mill scale, and other foreign substances by solvent or mechanical cleaning.

- 1. Touch-up shop-applied prime coats where damaged or bare, when required by other Sections of these Specifications. Clean and touch-up with the same type of shop primer.

D. Galvanized Surfaces: Remove oil and other surface contaminants with a non-petroleum based solvent. Apply a coat of etching primer if required by the paint manufacturer.

E. Cementitious Materials: Prepare cementitious surfaces of concrete, concrete blocks, cement plaster and cement-asbestos board to be painted by removing efflorescence, chalk, dust, dirt, grease and oils, and by roughening as required to remove glaze. Wash concrete surfaces scheduled to be painted with a commercial solution of muriatic acid, or other etching cleaner. Flush with clean water to neutralize the acid, and allow to dry before painting.

- 1. Determine the alkalinity and moisture content of surfaces to be painted by performing the appropriate tests. If surfaces are found to be sufficiently alkaline to cause blistering and burning of the finish paint, correct the condition before starting the application of paint.
- 2. Do not paint over surfaces where the moisture content exceeds that permitted in the manufacturer's printed instructions.
- 3. Clean floor surfaces, scheduled to be painted, with a commercial solution of muriatic acid, or other etching cleaner. Flush the floor with clean water to neutralize the acid, and allow to dry before painting.

F. Wood: Clean wood surfaces to be painted of dirt, oil, and other foreign substances with scrapers, mineral spirits, and sandpaper, as necessary. Sandpaper smooth, finished

PAINTING

09900-8

surfaces exposed to view, and remove dust. Scrape and clean small, dry, seasoned knots, and apply a thin coat of white shellac or other recommended knot sealer before application of the prime coat. After priming, fill holes and imperfections in finish surfaces with putty or plastic wood filler. Sandpaper smooth when dry.

- 1. Prime, stain, or seal wood required to be field painted, immediately upon delivery to the Project Site. Prime ends, edges, faces, undersides, and backsides of such wood, including cabinets, counters, cases and paneling.
  - 2. When a transparent finish is required, use spar varnish for backpriming.
  - 3. Backprime paneling on interior partitions where masonry, plaster, or other wet wall construction occurs on the backside.
  - 4. Seal tops, bottoms, and cut-outs of unprimed wood doors with a heavy coat of varnish or equivalent sealer immediately upon delivery to the Job Site.
- G. Gypsum Board: Fill minor defects with filler compound. Spot prime defects after repair.

### 3.3 MATERIALS PREPARATION

- A. Mix and prepare painting materials in accordance with the manufacturer's printed instructions.
- B. Maintain containers used in mixing and application of paint in a clean condition, free of foreign materials and residue.
- C. Stir materials before application to produce a mixture of uniform density, and stir as required during application. Do not stir surface film into the material. Remove the film and, if necessary, strain the material before using.

### 3.4 APPLICATION

- A. General:
  - 1. Apply paint products in accordance with the manufacturer's written directions using applicators and techniques best suited for the substrate, type of material being applied, and texture required.
  - 2. Paint finishes are scheduled. Provide prime coats compatible with the finish paints to be used.
  - 3. Apply additional coats, when the undercoats, stains, or other conditions show through the final coat, until the paint film is of uniform finish, color, and appearance. Give special attention to ensure that surfaces, including edges, corners, crevices, welds, and exposed fasteners receive a dry film thickness equivalent to that of flat surfaces.
  - 4. Paint surfaces behind movable equipment and furniture the same as similar exposed surfaces. Paint surfaces behind permanently fixed equipment and furniture with prime coat only before final installation of the item.
  - 5. Paint the back sides of access panels, and removable or hinged covers to match the exposed surfaces.
  - 6. Finish exterior doors on tops, bottoms and side edges the same as the exterior

PAINTING

09900-9

- faces.
7. Paint tops, edges, and bottoms of wood and hollow metal doors: . . .
  8. Sand lightly between each succeeding enamel and varnish coat.
  9. Omit the first coat (primer) on metal surfaces which have been shop-primed and touch-up painted, unless otherwise indicated.
  10. Apply each coat slightly darker than the preceding coat, unless otherwise approved by the Owner's representative. Sand surfaces lightly between coats, as necessary to achieve the specified finish.
  11. Do not apply finishes on surfaces that are not dry.
  12. The number of coats and the film thickness required is the same regardless of the application method. Do not apply succeeding coats until the previous coat has cured, as recommended by the paint manufacturer.
  13. Paint the interior surfaces of ducts, where visible through registers or grilles, with a flat, non-specular black paint.
  14. Apply block filler to concrete masonry units at the rate necessary to provide complete coverage with pores filled.
- B.** Scheduling Painting: Apply first coat material to surfaces that have been cleaned, pre-treated or otherwise prepared for painting as soon as practicable after preparation and before subsequent surface deterioration.
1. Allow sufficient time between successive coatings to permit proper drying. Do not re-coat until the paint has dried to where it feels firm, does not deform or feel sticky under moderate thumb pressure, and the application of another coat of paint does not cause lifting or loss of adhesion of the undercoat.
- C.** Minimum Coating Thickness: Apply materials at not less than the manufacturer's recommended spread rate to provide a total dry film thickness or, if not indicated, as recommended by the coating manufacturer.
- D.** Prime Coats: Apply a prime coat of material required to be painted or finished and has not been prime coated by others.
1. Re-coat primed and sealed surfaces where there is evidence of suction spots or unsealed areas in the first coat, to ensure a finish coat with no burn-through or other defects due to insufficient sealing.
- E.** Stipple Enamel Finish: Roll and re-distribute paint to an even and fine texture. Leave no evidence of rolling such as laps, irregularity in texture, skid marks, or other surface imperfections.
- F.** Pigmented (Opaque) Finishes: Completely cover surfaces to provide an opaque, smooth surface of uniform finish, color, appearance, and coverage. Cloudiness, spotting, holidays, laps, brush marks, runs, sags, ropiness and other surface imperfections are not acceptable.
- G.** Transparent (Clear) Finishes: Use multiple coats to produce a glass-smooth surface film of an even luster. Provide a finish free of laps, cloudiness, color irregularity, runs, brush

PAINTING

09900-10

- marks, orange peel, nail holes, and other imperfections.
1. Provide a satin finish for final coats, unless otherwise indicated.
- H.** Surfaces To Be Painted: Except where natural finish of material is specifically noted as a surface to not be painted, paint exposed surfaces whether or not colors are designated. Where items or surfaces are not specifically mentioned, paint the same as similar adjacent materials, or areas, if color or finish is not designated, the Architect will select from the manufacturer's standard colors or finishes.
- I.** Equipment in Finished Rooms: Unless otherwise authorized, paint wall grilles and diffusers, door louvers, panel board fronts and other equipment having a factory-finish, occurring in rooms other than storage, mechanical and custodial.
- J.** Do not paint over any code-required labels, such as Underwriter's Laboratories and Factory Mutual, or any other equipment identification, performance rating name, door label or nomenclature plates.
- K.** Paint exposed interior and exterior plumbing, heating and electrical equipment, apparatus, conduits, pipes and fittings, supports and hangers and all other unfinished surfaces of the mechanical and electrical work.
1. Work includes field painting of exposed bare and covered pipes and ducts (including color coding), and of hangers, exposed steel and iron work, and primer or factory-painted metal surfaces of equipment installed under the mechanical and electrical work, except as otherwise indicated.
- L.** Mechanical and Electrical Work: Painting of mechanical and electrical work includes those items exposed in mechanical equipment rooms, in occupied spaces, and equipment on roofs.
1. Exposed Mechanical: Items to be painted include, but are not limited to, the following:
    - a. Factory pre-painted diffusers at public spaces.
    - b. Ductwork insulation.
    - c. Piping, pipe hangers and supports.
    - d. Sprinkler covers and piping.
    - e. Heat exchangers.
    - f. Motors, mechanical equipment and supports.
    - g. Tanks.
    - h. Accessory items.
  2. Exposed Electrical: Items to be painted include, but are not limited to the following:
    - a. Panel boards in public spaces.
    - b. Speaker grilles.

PAINTING

09900-11

specified requirements, the Contractor may be directed to stop the painting work, remove the non-complying paint, pay for the testing, re-paint surfaces where the rejected paint has been applied, and remove the rejected paint from the previously painted surfaces if, upon re-painting with the specified paint, the two coatings are not compatible.

- M. Roof Flashings: Paint all exposed roof flashings that are not stainless steel or factory-finished.
- N. Completed Work: Match the approved samples for color, sheen, texture and coverage. Remove, re-finish or re-paint work not in conformance with the specified requirements.
- O. The following categories of work are not included as part of field-applied painting work.
  1. Concealed Surfaces: Unless otherwise indicated, painting is not required on surfaces such as walls or ceilings in concealed areas and generally inaccessible areas, foundation spaces, furled areas, utility tunnels, pipe spaces, duct shafts and elevator shafts.
  2. Finished Metal Surfaces: Unless otherwise indicated, metal surfaces of unfinished aluminum, anodized aluminum, stainless steel, chromium plate, copper, bronze and similar finished materials do not require finish painting.
  3. Operating Parts: Unless otherwise indicated, moving parts of operating units, mechanical and electrical parts, such as valve and damper operators, linkage, linkage, sensing devices, motor and fan shafts will not require finish painting.

3.5 MECHANICAL AND ELECTRICAL EQUIPMENT

- A. Replace identification markings on mechanical and electrical equipment, if painted over or spattered.
- B. Paint conduit and electrical equipment occurring in finished areas where exposed to public view, color and texture to match the adjacent surfaces.
- C. Paint front, back and all edges of plywood backboards for electrical equipment before installing, and mounting the equipment.

3.6 FIELD QUALITY CONTROL

- A. Section 01450 - Quality Control: Field inspection.
- B. The Owner reserves the right to invoke the following material testing procedures at any time, and any number of times during the field painting work.
  1. Engage the services of an independent testing laboratory to sample the paint being used. Samples of materials delivered to the Project Site will be taken, identified and sealed, and certified in the presence of the Contractor.
  2. A testing laboratory will perform appropriate tests for any or all of the following characteristics: abrasion resistance, apparent reflectivity, flexibility, washability, absorption, accelerated weathering, dry opacity, accelerated yellowness, re-coating, skinning, color retention, alkali resistance and quantitative materials analysis.
  3. If the test results show that the material being used does not comply with the

PAINTING

09900-12

3.7 CLEANING

- A. Section 01700 - Execution Requirements: Cleaning the installed work.
- B. As work proceeds, and upon completion, promptly remove paint where spilled, splashed, and spattered.
- C. During progress of the work keep the premises free from any unnecessary accumulation of tools, equipment, surplus materials, and debris.
- D. Remove from the site discarded paint materials, rubbish, cans and rags at the end of each work day.
- E. Collect waste, cleaning cloths, and materials which may constitute a fire hazard, place in closed metal containers, and remove from the site daily.
- F. Upon completion of the work leave the premises neat and clean. Clean metal door and window frames, glass, and other paint-spattered surfaces. Remove spattered paint by proper methods of washing and scraping, taking care to not scratch or otherwise damage finished surfaces.

3.8 PROTECTION

- A. Protect the work of other trades, whether to be painted or not, against damage by the painting and finishing work.
- B. Place "Wet Paint" signs as required as a warning of newly painted surfaces.
- C. Remove temporary protective wrappings provided by other trades for the protection of their work, after completion of the painting operations.
- D. Upon completion of the work of other trades, touch-up and restore all damaged and defaced painted surfaces.
- E. Correct any damage by cleaning, repairing or replacing and re-painting, as acceptable to the Owner's representative.
- F. Repair any damage resulting from inadequate and unsuitable protection.

3.9 SCHEDULE OF ITEMS TO BE PAINTED

- A. Refer to the Drawings and Painting and Finishing Schedule at the end of this Section for designated finishes. Paint finish shall be provided for, but not limited to, the following items:
  1. Interior: All interior surfaces as scheduled on the Drawings including, but not limited to:

PAINTING

09900-13

- a. Wood and hollow metal doors and frames.
  - b. Metal opening frames and trim.
  - c. Gypsum board.
  - d. Exposed concrete and plaster.
  - e. Steel rails and guards.
  - f. Exposed mechanical ductwork, hangers and supports, if the exposed structure is shown on the Drawings to be painted.
  - g. Exposed piping, hangers and supports, if scheduled on the Drawings to be painted.
  - h. Exposed conduit, hangers and supports, if scheduled on the Drawings to be painted.
  - i. Exposed structure including decking, joists, girders, beams, bridging, and miscellaneous metal fabrications, if scheduled on the Drawings to be painted.
  - j. Exposed structural columns.
  - k. Metal stair stringers and handrails.
  - l. Exposed wood trim.
2. Exterior: All exterior surfaces including, but not limited to:
- a. Wood and hollow metal doors and frames.
  - b. Metal opening frames and trim.
  - c. Metal flashings, if exposed from ground level, and downspouts, other than stainless steel.
  - d. Pipe bollards.
  - e. Steel rails and guards.
  - f. Roof hatches.
  - g. Concrete and plaster walls, soffits, fascia, ceilings, beams and columns.
  - h. Structural steel decking, joists, beams and columns.
- B. Do not paint the following items:
- 1. Aluminum, brass, bronze, stainless steel and chrome-plated steel.
  - 2. Pre-finished items, such as cabinetry, toilet compartments, acoustical ceiling materials, and mechanical and electrical equipment.
  - 3. UL, FM, and other Code required labels.

- 4. Equipment identification, performance ratings, and name plates.
- 5. Finish hardware.
- 6. Toilet accessories.

3.10 PAINTING TREATMENTS SCHEDULE

General: The paint abbreviations below refer to those noted above in PART 2, MATERIALS.

NO.	LOCATION	MATERIALS
1	Exterior and Interior Metal including factory prefinished items scheduled for field finish	Shop Coat: As specified in other Sections Prime Coat: (RIP) Finish: Two coats (AREM)
2	Exterior Plaster, Concrete and Masonry where noted for paint including: Fascia, Soffits, Walls of Buildings, Exposed Concrete Beams, Exposed Concrete Retaining Walls	Prime Coat: Manufacturer's Representative Finish: Two coats (EAE)
3	Exterior Plaster and Concrete where noted for Textured Coating (other than Special Coating per Section 09800) including: Fascia, Soffits, Walls of Building, exposed Concrete Beams, exposed Concrete Retaining Walls	Prime Coat: As recommended by manufacturer Finish: (EAHE) system or Prime Coat: XL-70 primer Finish: (TC)
4	Exterior Wood	Wood Stain: Two coats (WS) or Prime and Two coats (AREW)
5	Interior Smooth Concrete and	Prime Coat: (PS)
6	Interior Masonry, where scheduled	Prime Coat: (BF) Finish: Two coats (AEE) or (AFE)
7	Interior Wood for opaque finish including Wood Doors	Prime Coat: Manufacturer recommended primer Finish: Two coats (AEE) or (AFE)

PAINTING

09900-14

PAINTING

09900-15

8	Interior Hardwood, natural finish, including Doors, Door and Window Frames and Relights, Panels and all Trim, Wood-Faced Casework	<u>Finish:</u> Two coats (DO) or two coats (WS) with sanding sealers <u>Sealer:</u> Two coats (PSU) or <u>Finish:</u> Three coats (CWF)
9	Interior Concrete, Masonry and	<u>Prime Coat:</u> As recommended by manufacturer
10	Maintenance coating for interior smooth Concrete, Masonry, Gypsum Board and Wood	<u>Prime Coat:</u> As recommended by manufacturer <u>Finish:</u> (LOAE) Coats as required for coverage
11	Interior Metal including factory pre-finished items scheduled for painting	<u>Prime Coat:</u> (RIP) except where pre-finished <u>Finish:</u> Two coats (ARENT)
12	Interior Metal where noted for epoxy	<u>Prep Coat:</u> JASCO Prep and Primer <u>Prime Coat:</u> Aro-Gard 561 primer <u>Finish:</u> Two coats (EPM)
13	Graffiti Resistant Coating over specified paint system.	<u>Finish:</u> Three coats (GRC)
14	Stained concrete or plaster: (CS) per manufacturer's recommendation.	
15	Sealed concrete or plaster:	<u>Finish:</u> Three coats (TEC) or per manufacturer's recommendation

END OF SECTION

PAINTING 09900-16

SECTION 10200  
LOUVERS AND VENTS

PART 1 GENERAL

1.1 SUMMARY

- A. Section Includes:
1. Fixed aluminum wall louvers.
  2. Bird screens.
- B. Related Documents: The Contract Documents, as defined in Section 01010 - Summary of Work, apply to the work of this Section. Additional requirements and information necessary to complete the work of this Section may be found in other Documents.
- C. Related Sections:
1. Section 03300 - Cast-In-Place Concrete: Substrate for attachment of units.
  2. Section 04230 - Reinforced Unit Masonry: Substrate for attachment of units.
  3. Section 07900 - Joint Sealers: Perimeter sealant at louver and vent frames.

1.2 DESCRIPTION OF WORK

- A. The extent of the louvers and vents work is indicated on the Drawings and as specified herein, and includes providing and installing louvers and vents with bird screens, anchor devices, flashings and sealants necessary for complete and weather-tight installations.
- B. The work of this Section does not include providing and installing louvers for doors specified in Sections 08100 and 08210.

1.3 REFERENCES

- A. The publications listed below form a part of this Specification to the extent referenced. Publications are referred to in the text by basic designation only.
- B. American Society of Civil Engineers (ASCE):
1. ASCE / SEI 7 - Minimum Design Loads for Buildings and Other Structures.
- C. American Society for Testing and Materials (ASTM):
1. ASTM B 221 - Aluminum-Alloy Extruded Bars, Rods, Wire, Shapes, and Tubes.
  2. ASTM E 330 - Test Method for Structural Performance of Exterior Windows, Doors, Skylights and Curtain Walls by Uniform Static Air Pressure Difference.
  3. ASTM E 1996 - Specification for Performance of Exterior Windows, Curtain Walls, Doors, and Impact Protective Systems Impacted by Windborne Debris in Hurricanes.

LOUVERS AND VENTS 10200-1

- D. International Code Council:
1. International Building Code (IBC), 2009.
- 1.4 SUBMITTALS
- A. Section 01330 - Submittal Procedures: Procedures for submittals.
    1. Product Data: Provide data describing the design characteristics, maximum recommended air velocity, design free area, materials and finishes.
    2. Shop Drawings: Indicate louver layout plan and elevations, openings and clearance dimensions, tolerances; head, jamb and sill details; blade configuration, screens, blankout areas, and frames.
    4. Samples: When requested, submit 6" X 6" square of each required finish. Prepare samples on metal of the same gage and alloy as that to be used in the work. Where color variations are to be expected, submit two (2) or more samples showing the limits of such variations.
    5. Assurance / Control Submittals:
      - a. Manufacturer's certificate that the Products meet or exceed the specified requirements.
      - b. Calculations indicating that the products and anchorages satisfy the performance requirements.
      - c. Documentation of experience indicating compliance with the specified qualifications requirements.
- 1.5 COORDINATION
- A. Verify size, locations and placement of louver units prior to fabrication, wherever possible.
  - B. Coordinate with the mechanical subcontractor for size and location of required louvers and vents.
  - C. Where size or location of louvers or vents differ with the Drawings, notify the Owner's representative.
- 1.6 QUALITY ASSURANCE
- A. Qualifications:
    1. Manufacturer: Company specializing in manufacturing the products specified with a minimum of five (5) years documented experience.
  - B. Performance Requirements:
    1. Provide capacity to withstand the following loading requirements for exterior units:
      - a. Design and install to resist combined positive and negative windloading in accordance with IBC 2009, Section 1609 with a Vmph of 170, qs of 7.4.0 psf, exposure [B] [C] [D], and importance factor of [1.0] [1.25] [1.5], as applicable per ASCE 7.
- 1.7 DELIVERY, STORAGE AND HANDLING
- A. Section 01600 - Product Requirements: Transport, handle, store and protect the products.
  - B. Protect finished aluminum surfaces with a stripable coating. Do not use adhesive papers or sprayed coatings which bond when exposed to sunlight or weather.
  - C. Deliver product to the Project Site in the manufacturer's original, unopened protective packaging.
- PART 2 PRODUCTS
- 2.1 MANUFACTURERS
- A. Subject to compliance with the Project requirements, manufacturers offering products which may be incorporated into the work include the following:
    1. The Airoilite Co.
    2. Airline Products, Nystrom Building Products.
    3. Construction Specialties, C/S Louvers.
  - B. Section 01600 - Product Requirements: Product Options: Substitutions permitted.
- 2.2 MATERIALS
- A. Aluminum: ASTM B 221, extruded shapes.
  - B. Bird Screen: 1/4" x 1/4" mesh, aluminum, set in aluminum frame.
- 2.3 ACCESSORIES
- A. Fasteners and Anchors: Stainless steel.
  - B. Flashings: Of the same material as the louver frame.
  - C. Sealants: As specified in Section 07900 - Joint Sealers.
- 2.4 FABRICATION
- A. Louver Panel Thickness: 6" deep; face measurements as shown on the Drawings.
  - B. Louver Blade Design: Weatherproof, minimum material thickness of 0.081"; integral and lateral rain water stops positioned on the blades.
  - C. Louver Frame: Channel shape, mechanically fastened corner joints, minimum material thickness of 0.081".
  - D. Head and Sill Flashings: Extruded to the required shapes, single length, in one piece per location.

LOUVERS AND VENTS

10200-2

LOUVERS AND VENTS

10200-3

- E. Screens: Install screen mesh in shaped frames, reinforce corner construction, shop install to the louvers with non-ferrous fasteners.
- 2.5 FINISH
- A. Exposed Aluminum Surfaces: Clear anodized or as selected from the manufacturer's standard finishes.
- B. Maintain same color range within each unit. Do not mix light and dark shades within an assembly.
- PART 3 EXECUTION
- 3.1 EXAMINATION
- A. Section 01700 - Execution Requirements: Verification of existing conditions before starting the work.
- B. Verification of Conditions: Verify that field measurements, surfaces, substrates and conditions are as required, and ready to receive the work.
- C. Report in writing, prevailing conditions that will adversely affect satisfactory execution of the work of this Section. Do not proceed with the work until the unsatisfactory conditions have been corrected.
- 3.2 INSTALLATION
- A. Install louver assemblies in accordance with the manufacturer's published instructions.
- B. Install louvers level, plumb, free of rack and securely attached to the structure.
- C. Install flashings and align louver assemblies to ensure that moisture sheds from the flashings, and to the exterior.
- D. Secure louvers in opening framing with concealed fasteners as required to meet the Performance Requirements.
- E. Install perimeter sealant in accordance with Section 07900 - Joint Sealers.
- 3.3 ISOLATION REQUIREMENTS
- A. Dissimilar Metals: Where aluminum surfaces are in contact with, or fastened to dissimilar metals except stainless steel, zinc or zinc coating, the aluminum shall be protected from the dissimilar metal. Where aluminum contacts another metal, paint the dissimilar metal with epoxy paint. Where drainage from a dissimilar metal passes over aluminum, paint the dissimilar metal with a non-lead pigmented paint.
- B. Cementitious Materials: Paint aluminum where in contact with mortar, concrete, masonry or other cementitious material, with an alkali-resistant coating such as heavy-bodied bituminous paint or epoxy paint.
- C. Wood Contact: Isolate aluminum from cedar, redwood, oak and acid-treated lumber by means of unbroken 6-mil polyethylene construction sheet or a heavy coating of metal-protective paint.
- D. Surfaces in contact with sealants after installation need not be coated with any type of

LOUVERS AND VENTS 10200-4

- protective material.
- 3.4 PROTECTION
- A. Protect the finish from damage during construction by the use of temporary protective coverings approved by the manufacturer.
- 3.5 ADJUSTING
- A. Section 01700 - Execution Requirements: Adjusting the installed work.
- B. Remove protective covering at project completion or when directed by the Owner's representative.
- C. Restore finishes damaged during installation and construction so no evidence of the corrective work remains.
- D. Return items which cannot be refinished in the field to the shop, make the necessary alterations, and refinish the entire unit, or provide a new unit.
- 3.6 FIELD QUALITY CONTROL
- A. Section 01450 - Quality Control: Field inspection.
- B. Inspect the installations for correct location, alignment and elevation, plumb, level, true to line, free of rack and secure attachment and anchorage.
- 3.7 CLEANING
- A. Section 01700 - Execution Requirements: Cleaning installed work.
- B. Immediately prior to final inspection, remove protective wrappings.
- C. Wipe down all louver blades and frames before final acceptance.

END OF SECTION

LOUVERS AND VENTS 10200-5



SECTION 10810

TOILET ACCESSORIES

PART 1 GENERAL

1.1 SUMMARY

- A. Section Includes:
  - 1. Toilet accessories.
  - 2. Attachment hardware.
- B. Related Documents: The Contract Documents, as defined in Section 01010 - Summary of Work, apply to the work of this Section. Additional requirements and information necessary to complete the work of this Section may be found in other Documents.
- C. Related Sections:
  - 1. Section 06100 - Rough Carpentry: Placement of backing and blocking for attachment of accessories.
  - 2. Section 09110 - Non-Load Bearing Steel Framing: Placement of backing plate reinforcement for attachment of accessories.
  - 3. Section 10158 - Phenolic Toilet Partitions: Substrate for mounting toilet accessories.
  - 4. Section 10165 - Plastic Laminate Toilet Partitions: Substrate for mounting toilet accessories.

1.2 DESCRIPTION OF WORK

- A. The extent of toilet accessories work is indicated on the Drawings and as specified herein, and includes providing and installing the various accessory types, locks, keys and miscellaneous attachment hardware.
- B. Mounting heights for toilet accessories shall comply with ADAAG, as applicable.

1.3 REFERENCES

- A. The publications listed below form a part of this Specification to the extent referenced. Publications are referred to in the text by basic designation only.
- B. American Society for Testing and Materials (ASTM):
  - 1. ASTM A 123 - Specification for Zinc (Hot-Dip Galvanized) Coatings on Iron and Steel Products.
  - 2. ASTM A 167 - Specification for Stainless and Heat-Resisting Chromium-Nickel Steel Plate, Sheet, and Strip.
  - 3. ASTM A 366 - Specification for Steel, Carbon, Cold-Rolled, Commercial Quality.

TOILET ACCESSORIES

10810-1

C. Americans with Disabilities Act Accessibility Guidelines (ADAAG):

- 1. Accessibility Guidelines for Buildings and Facilities.
- 2. Accessibility Guidelines for Schools.

1.4 SUBMITTALS

- A. Section 01330 - Submittal Procedures: Procedures for submittals.
  - 1. Product Data: Manufacturer's catalog and data for each accessory describing size, finish, details of function and attachment method.
  - 2. Samples: Submit one (1) sample of each item and model specified, if requested.
  - 3. Manufacturer's recommended maintenance and operating instructions, parts manual and keys for each item and lock.
  - 4. Assurance / Control Submittals:
    - a. Manufacturer's certificate that products meet or exceed the specified requirements.
    - b. Documentation of experience indicating compliance with the specified qualifications requirements.
- B. Section 01780 - Closeout Submittals: Procedures for closeout submittals.
  - 1. Deliver accessories Schedule, keys and Parts Manual for Owner's permanent records. Provide two (2) sets of the following items of manufacturer's literature:
    - a. Technical Data sheets for each accessory item.
    - b. Service and Parts Manuals.
    - c. Name of a local representative to be contacted in the event of need for field service or consultation.
  - 2. Warranty: Submit a manufacturer's special Warranty with forms completed in the name of the Owner and registered with the manufacturer.

1.5 QUALITY ASSURANCE

- A. Qualifications:
  - 1. Manufacturer: Company specializing in manufacturing the products specified with a minimum of five (5) years documented experience.
  - 2. Installer: Company experienced in performing the work of this Section with a minimum of five (5) years documented experience.
- B. Regulatory Requirements: Comply with Americans with Disabilities Act Accessibility Guidelines (ADAAG). Verify mounting heights and clearances prior to installation.
- C. All accessories alike shall be the product of a single manufacturer.

TOILET ACCESSORIES

10810-2

- D. Keyed (tumbler lock) accessories shall be keyed alike except for coin receiving boxes on vending equipment.
- 1.6 DELIVERY, STORAGE AND HANDLING
- A. Section 01600 - Product Requirements: Transport, handle, store and protect products.
- B. Deliver products to the Project Site in the manufacturer's original, unopened protective packaging, labeled bearing the manufacturer's name and the type of accessory.
- C. Store materials in their original protective packaging to prevent soiling, wetting and physical damage.
- D. Handle to prevent damage to finish surfaces.
- E. Maintain protective covers on all units until installation has been completed. Remove coverings during final clean-up.

1.7 WARRANTY

- A. Section 01780 - Closeout Submittals: Procedures for closeout submittals.
- B. Special Warranty:
1. Provide a written Warranty signed by the manufacturer certifying that the products are free of defective materials and workmanship and agreeing to replace or repair any defective item, in whole or in part, as necessary to restore the product to its original intended state and integrity.
  2. Warranty Period:
    - a. Stainless Mirror Frames: Fifteen (15) years against corrosion.
    - b. Plate Glass Mirrors: Fifteen (15) years against silver spoilage.
    - c. Tempered Glass Mirrors: Five (5) years against silver spoilage.
    - d. Laminated Glass: Five (5) years against silver spoilage.
    - e. Hand Dryers: Ten (10) years.

PART 2 PRODUCTS

2.1 MANUFACTURERS

- A. Subject to compliance with the Project requirements, manufacturers offering the specified items which may be incorporated into the work include the following:
1. American Specialties, Inc.
  2. Bobrick Washroom Equipment, Inc.
  3. Bradley Corp.
  4. GOJO Corporation

5. San Jamar Oceans Corporation
  6. TC Corporation
- B. Section 01600 - Product Requirements: Product Options: Substitutions permitted.
- 2.2 MATERIALS
- A. Sheet Steel: ASTM A 366.
  - B. Galvanized Sheet Steel: ASTM A 366, ASTM A 123 to 1.25 ounces per square foot.
  - C. Stainless Steel Sheet: ASTM A 167, Type 304.
  - D. Expansion Shields: Fiber, lead or rubber as recommended by the accessory manufacturer for the component and substrate.
  - E. Fasteners, Screws and Bolts: Hot-dip galvanized, tamper-proof. The finish of exposed fasteners shall match the finish of the item secured.

2.3 MANUFACTURED UNITS

- A. TA-1 Liquid Soap Dispenser:
1. Model Numbers:
    - a. American Specialties: 9343.
    - b. Bobrick: B-2112.
    - c. Bradley: 6542.
  2. Description: Surface-mounted, horizontal tank-type dispenser for all-purpose liquid soap. 22 gage, Type 304 satin finish stainless steel container; drawn one-piece seamless body; mounting bracket attached to back plate for attachment to wall plate; concealed, vandal-resistant mounting. Unbreakable, clear acrylic refill indicator window; lockable hinged stainless steel lid for top filling; special key. Capacity: minimum, 40 ounces. Molded plastic push button and spout. Corrosion resistant to most soaps and detergents. ADAAG compliant.

TA-1A Touch Free Foam Soap Dispenser

1. Model Number:
    - a. GoJo TFX 5362.02
    - b. TC #450017
  2. Description: Surface mounted foaming hand soap dispenser. Refillable. Battery operated automatic touch free dispenser, with skylight window. ADA compliant. 1200 mL refills.
  3. Refills: Provide two (2) additional refill packets for each soap dispenser
- B. TA-2 Mirror with Stainless Steel Frame:
1. Model Numbers:

TOILET ACCESSORIES 10810-3

TOILET ACCESSORIES 10810-4

- f. American Specialties: 0600.
  - g. Bobrick: B-290 Series.
  - h. Bradley: 780 Series.
2. Description: 1/4" polished, tempered glass mirror. One-piece, roll-formed, 18 gage, Type 304 satin finish stainless steel angle frame; mitered corners welded, ground and polished. Concealed hanging bracket locked into top and bottom of frame with tamper-proof set screws. One piece water-resistant back attached to frame with theft-resistant locking device. Manufacturer's standard size, as indicated.
- C. TA-3 Stainless Steel Mirror:
- 1. Model Numbers:
    - a. American Specialties: 0600.
    - b. Bobrick: B-290 Series.
    - c. Bradley: 780 Series.
2. Description: Same as TA-2 except with Type 304 polished stainless steel mirror.
- D. TA-4 Combination Paper Towel Dispenser and Waste Receptacle:
- 1. Model Numbers:
    - a. American Specialties: 0469.
    - b. Bobrick: B-3944.
    - c. Bradley: 234.
  - 2. Description: Recessed, 22 gage, Type 304 satin finish stainless steel, all-welded cabinet. 22 gage, satin finish stainless steel, drawn and beveled one-piece seamless flange. 22 gage, Type 304 satin finish stainless steel dispenser door secured to cabinet with full-length stainless steel piano hinge; semi-concealed tumbler lock. 22 gage, Type 304 satin finish stainless steel dispenser; rounded towel tray with hemmed opening. Capacity: 600 C-fold or 800 multi-fold paper towels. 22 gage, Type 304 satin finish stainless steel waste receptacle; all edges hemmed; secured to cabinet with tumbler lock. Capacity: 12 gallons. Interior hooks for optional vinyl liner. ADAAG compliant.
- E. TA-5 Paper Towel Dispenser:
- 1. Model Numbers:
    - a. American Specialties: 0215.
    - b. Bobrick: B-2621.
    - c. Bradley: 252.
2. Description: Surface-mounted, 22 gage, Type 304 satin finish stainless steel, all-welded cabinet. Hemmed opening towel tray. 22 gage, Type 304 satin finish stainless steel door, secured to cabinet with full-length stainless steel piano hinge; tumbler lock. Capacity: 200 C-fold or 275 multi-fold paper towels. ADAAG compliant.
- TA-5A Automatic Paper Towel Dispenser
- 1. Model Numbers:
    - a. San Jamar Oceans Tear-N-Dry
    - b. Kinverly KP-02
  - 2. Description: Touchless towel dispensing system with automatic portion control to dispense, adjustable sheet length setting. Battery operated, dispenser automatically operates with user's motion. For rolls 8" wide x 8 2" diameter and 4" diameter stub roll with lock.
  - 3. Refills: Provide six (6) refill rolls for each towel dispenser.
- F. TA-6 Waste Receptacle:
- 1. Model Numbers:
    - a. American Specialties: 0828.
    - b. Bobrick: B-279.
    - c. Bradley: 357
  - 2. Description: Surface-mounted; 22 gage, Type 304 satin finish stainless steel. Top and bottom edges hemmed. Minimum 6.5 gallons capacity. Hooks for re-useable vinyl liner.
- G. TA-7 Electric Hand Dryer:
- 1. Model Numbers:
    - a. American Specialties: 0185.
    - b. Bobrick: B-7507.
    - c. Bradley: 2899-28.
  - 2. Description: One piece cast-iron housing, high gloss porcelain enamel finish; acid-resistant; automatic sensor. 4" projection, maximum. ADAAG compliant.
- H. TA-8 Touchless Paper Towel Dispenser:
- 1. Model Numbers:
    - a. Bradley: 2490.
    - b. Maintex, Inc: enMotion.

TOILET ACCESSORIES

10810-5

TOILET ACCESSORIES

10810-6

2. Description: Surface-mounted, automatic touchless paper towel dispenser. Battery operated; high impact translucent plastic door; roll towels; key-activated spring lock.
- I. TA-9 Sanitary Napkin / Tampon Dispenser:  
 1. Model Numbers:  
 a. American Specialties: 0468.  
 a. Bobrick: 3500 Series.  
 b. Bradley: 4017 Series.
2. Description: Semi-recessed, 18 or 22 gage, Type 304 satin finish stainless steel cabinet. 18 gage, Type 304 satin finish stainless steel door attached to cabinet with full-length stainless steel piano hinge held closed with two (2) tumbler locks keyed alike with manufacturer's other accessories. 22 gage stainless steel internal coin box secured by separate lock; keyed differently from door locks. Coin mechanism convertible; replaceable in the field without removing cabinet; factory installed coin operation denomination to be determined. Body and door of welded construction with burr-free edges; no exposed fasteners or welded seams. Provide collar, as necessary, for semi-recessed mounting. Capacity: 30 napkins and 27 tampons, minimum. ADAAG compliant.
- J. TA-10 Partition-Mounted, Dual Access Sanitary Napkin / Tampon Disposal:  
 1. Model Numbers:  
 a. American Specialties: 0472 (for two compartments) / 0473 (for single end compartment).  
 b. Bradley: 4721-15 (for two compartments) / 4722-15 (for single end compartment).
2. Description: Partition-mounted dual napkin disposal; serves two compartments. 22 gage, Type 304 satin finish stainless steel flanges; one-piece seamless construction, 1" wide with 1/4" return, adjustable for partitions thickness. 22 gage, Type 304 satin finish stainless steel cabinet. All welded construction with one flange welded to cabinet. 22 gage, Type 304 satin finish stainless steel, self-closing push flap door on each side; heavy-duty, full-length, spring loaded, stainless steel piano hinges; doors operate independently. 22 gage, Type 304 stainless steel waste container with tumbler locks keyed alike with manufacturer's other accessories; hemmed finger grip, removable from one side only. Capacity: 1.5 gallons. Body and doors, welded construction; burr-free beveled edges. International graphic waste symbol affixed to doors. ADAAG compliant.
- End compartment unit similar but recess-mounted in side wall.
- K. TA-11 Toilet Seat Cover Dispenser:  
 1. Model Numbers:  
 a. American Specialties: 0477SM.  
 b. Bobrick: B-221.  
 c. Bradley: 583.

TOILET ACCESSORIES 10810-7

- L. TA-12 Multi-Roll Tissue Dispenser:  
 1. Model Numbers:  
 a. American Specialties: 9030.  
 b. Bobrick: B-2888.  
 c. Bradley: 5402.
2. Description: Surface-mounted; 22 gage, Type 304 satin finish stainless steel cabinet. All welded construction. 18 gage drawn, one-piece, Type 304 satin finish stainless steel door, pivot hinge and tumbler lock. 18 gage stainless steel dispensing mechanism, inner housing and cam. Heavy-duty, one-piece, theft-resistant, molded ABS spindles. Holds 2 standard core 5-1/4" diameter tissue rolls. Reserve roll automatically drops in-place when bottom roll is depleted.

- M. TA-13 Toilet Grab Bar:  
 1. Model Numbers:  
 a. American Specialties: 3100 Series, Type - 56.  
 b. Bobrick: B-5637.  
 c. Bradley: 832 Series.

2. Description: Heavy-duty, 1-1/4" diameter, horizontal, 1-1/2" wall clearance. 18 gage, Type 304 satin finish stainless steel. Concealed screw attached mounting and anchorage. 3" flange; 11 gage, Type 304 satin finish stainless steel. Minimum 900 pounds supporting capacity. Length as indicated, ADAAG compliant.
- N. TA-14 Robe Hooks:  
 1. Model Numbers:  
 a. American Specialties: 7345.  
 b. Bobrick: B-6727.  
 c. Bradley: 9124.

2. Description: Double robe hook, Type 304 satin finish stainless steel. Concealed mounting. 4" wide bar with end hooks. Projects 1-5/8", minimum, from wall.
- O. TA-15 Shower Curtain Rod / Hooks / Curtain:  
 1. Model Numbers:  
 a. American Specialties: 1214 / 1200-SHU / 1200-V.

TOILET ACCESSORIES 10810-8

- b. Bobrick: B-6107 / 204-1 / 204-3.
  - c. Bradley: 953 / 9536 / 9537.
  - 2. Description: Heavy-duty, 20 gage, 1" diameter, Type 304 satin finish stainless steel rod; screw anchored attachment; length as required. Stainless steel hooks for 1" rod. 8 gage, flame-resistant, anti-bacterial vinyl fabric shower curtain, length as required; color white.
- P. TA-16 Soap Dish:
- 1. Model Numbers:
    - a. American Specialties: 7404.
    - b. Bobrick: B-4380.
  - 2. Description: Recessed, heavy-duty, one-piece construction, drawn and seamless. 22 gage, Type 304 satin finish stainless steel.
- Q. TA-17 Shower / Tub Grab Bar:
- 1. Model Numbers:
    - a. American Specialties: Series 3100, Type-02.
    - b. Bobrick: B-5806 Series.
    - c. Bradley: 832 Series.
  - 2. Description: 1-1/4" diameter, diagonal, 1-1/2" wall clearance, 18 gage, Type 304 satin finish stainless steel. Peened grip. Concealed screw attached mounting and anchorage. 3" flange, 11 gage, Type 304 satin finish stainless steel. Minimum 900 pounds supporting capacity. Length as indicated. ADAAG compliant.
- R. TA-18 Shower Seat:
- 1. Model Numbers:
    - a. American Specialties: 8206.
    - b. Bobrick: B-5181.
    - c. Bradley: 9569.
  - 2. Description: Reversible, folding seat. Type 304 satin finish stainless steel frame, legs, flanges and bracket. 1/2" thick solid phenolic slatted seat; self-locking mechanism. Color as selected. ADAAG compliant.
  - 3. Provide one at each accessible Shower.
- S. TA-19 Corner Shower Seat:
- 1. Model Numbers:
    - a. American Specialties: 0010.

TOILET ACCESSORIES 10810-9

- b. Bradley: 954.
  - 2. Description: Folding, corner-mounted; Type 304 satin finish stainless steel seat, support brackets and retainer clip. Secured to one wall with full length stainless steel piano hinge and other wall by bracket. Retainer clips to hold seat upright. Channel formed edges. Size: 15" x 15".
- T. TA-20 Mop Holder:
- 1. Model Numbers:
    - a. American Specialties: 1315.
    - b. Bobrick: B-224.
  - 2. Description: 18 gage, Type 304 satin finish stainless steel, 8" deep shelf with return, 36" long, 4 rubber mop holders, 3 rag hooks, rod below shelf.
- 2.4 MANUFACTURED UNITS FOR APARTMENT BATHROOMS (ATA)
- A. ATA-1 Medicine Cabinet, Recessed:
- 1. Model Number:
    - a. American Specialties: 0952.
    - b. Bobrick: B-398.
    - c. Bradley: 175.
  - 2. Description: Recessed, satin finish stainless steel cabinet. Swing door with 1/4" plate glass mirror. 20 gage cabinet and mirror frame. 3 stainless steel adjustable shelves. Full-length heavy-duty stainless steel piano hinge, magnetic catch. Approximately 16" W x 26" H x 3-5/8" D.
  - 3. One each Bathroom.
- B. ATA-2 Towel Bar:
- 1. Model Number:
    - a. American Specialties: 7360.
    - b. Bobrick: B-673.
    - c. Bradley: 9055.
  - 2. Description: 3/4" square, heavy-gage, Type 304 bright polished stainless steel tubing, 22 gage, Type 304 stainless steel flanges and support arms. 16 gage, concealed stainless steel mounting brackets. All welded construction. Secured with stainless steel locking set-screws, 16 gage, Type 304 stainless steel wall plates. 3-1/4" projection, minimum; length as shown.
  - 3. One each Bathroom.
- C. ATA-3 Toilet Tissue Holder:

TOILET ACCESSORIES 10810-10

1. Model Number:
- American Specialties: 7305.
  - Bobrick: B-685.
  - Bradley: 5085.
2. Description: Surface-mounted, bright polished stainless steel, standard size tissue holder. Chrome-plated plastic spindle.
3. One each watercloset.
- D. ATA-4 Toilet Grab Bar:
1. Model Number:
- American Specialties: 3100 Series, Type 56.
  - Bobrick: B-5837.
  - Bradley: 832 Series.
2. Description: See TA-13.
3. One each watercloset.
- E. ATA-5 Shower / Tub Grab Bar:
1. Model Number:
- American Specialties: 3100 Series, Type-02.
  - Bobrick: B-5806 Series.
  - Bradley: 832 Series.
2. Description: See TA-17.
3. One each Shower / Bath tub.
- F. ATA-6 Shower Curtain Rod / Hooks / Curtain:
1. Model Number:
- American Specialties: 1214 / 1200-SHU / 1200-V.
  - Bobrick: B-6107 / 204-1 / 204-3.
  - Bradley: 953 / 9536 / 9537.
2. Description: See TA-15.
3. One each Shower / Bath tub.
- G. ATA-7 Towel Pin:
1. Model Number:
- American Specialties: 7301.
  - Bobrick: B-677.
  - Bradley: 9315.
2. Description: 10 gage, Type 304 stainless steel cap welded to support arm. 22 gage, Type 304 stainless steel flange and support arm. 16 gage, concealed stainless steel mounting bracket. All welded construction. Secured with stainless steel set-screws. 16 gage, Type 304 stainless steel wall plate. 3-3/8", minimum projection. Bright polished finish. ADAAG compliant.
3. One each Bathroom.
- H. ATA-8 Shower Seat:
1. Model Number:
- American Specialties: 8205-R / L.
  - Bobrick: B-517 / 518.
2. Description: 1-1/2" thick, foam padded, fold-down seat. White / off-white water-resistant naugahyde cover on enclosed 1/2" thick marine grade plywood base. Stainless steel frame and mounting brackets; self-locking mechanism. Right or left hand to suit conditions. ADAAG compliant.
3. One each Shower.
- I. ATA-9 Soap Dish, Recessed:
1. Model Number:
- American Specialties: 0398.
  - Bobrick: B-4390.
  - Bradley: 940.
2. Description: Recessed, heavy-duty, stainless steel dish with bar. 19 gage, Type 304 stainless steel. Drawn and beveled, one-piece, seamless construction. 22 gage, Type 304 stainless steel retaining clip. 3/16" thick, Type 304 stainless steel bar. Matte polished finish.
3. One each Shower / Bath tub.
- 2.5 FABRICATION
- Weld and grind smooth joints of fabricated components.
  - Form exposed surfaces from single sheet of stock, free of joints. Form surfaces flat without distortion. Maintain surfaces without scratches and dents.
  - Fabricate grab bars of tubing, free of visible joints, return to wall with end attachment flanges.

TOILET ACCESSORIES 10810-12

TOILET ACCESSORIES 10810-11

- D. Shop assemble components and package complete with fittings and anchors.
- E. Provide steel anchor plates, adapters and anchor components necessary for secure installation.
- F. Back paint components where in contact with building finishes to prevent electrolysis.

PART 3 EXECUTION

3.1 EXAMINATION

- A. Section 01700 - Execution Requirements: Verification of existing conditions before starting the work.
- B. Verification of Conditions: Verify that field measurements, surfaces, substrates and conditions are as required, and ready to receive the work.
  1. Verify that wall openings for recessed accessories are correctly located and of proper dimensions.
  2. Verify that attachment blocking and backing plates are in place, plumb and level, and in the correct location for attachment of accessories.
  4. Check areas to receive surface-mounted accessories for conditions that would affect quality and execution of the work.
  5. Verify spacing of plumbing fixtures and toilet partitions that affect installation of accessories.
- C. Report, in writing, prevailing conditions that will adversely affect satisfactory execution of the work of this Section. Do not proceed with the work until the unsatisfactory conditions have been corrected.

3.2 PREPARATION

- A. Deliver inserts and rough-in frames to the Project Site for scheduled installation.
- B. Provide and use templates and rough-in measurements as required.

3.3 INSTALLATION

- A. Install fixtures, accessories, and items in accordance with the manufacturer's instructions, ADAAG and as indicated on the Drawings.
- B. Install at the locations and heights indicated or as required, plumb and level, securely and rigidly anchored to the substrate.
- C. Install manufacturer's recommended anchor system for all grab bars.
- D. Conceal evidence of drilling, cutting and fitting on adjacent finishes.
- E. Fit flanges of accessories snug to wall surfaces. Provide caulking in gaps between 90 degrees return flanges and finish wall surface after accessories are installed.

3.4 ADJUSTING

- A. Section 01700 - Execution Requirements: Adjusting the installed work.

TOILET ACCESSORIES 10810-14

TOILET ACCESSORIES

10810-13

- B. Adjust accessories for proper operation.
- C. Verify that mechanisms function smoothly.

3.5 FIELD QUALITY CONTROL

- A. Section 01450 - Quality Control: Field inspection.
- B. Inspect accessories to ensure secure attachment to the substrates, proper locations and mounting heights in compliance with ADAAG.

3.6 CLEANING

- A. Section 01700 - Execution Requirements: Cleaning the installed work.
- B. Remove temporary labels and protective coatings.
- C. Clean and polish exposed surfaces prior to final inspection.

END OF SECTION

SECTION 15400

INTERIOR PLUMBING SYSTEM

B. Replacements: In the event of damage, immediately make all repairs and replacements necessary to the approval of the Architect and at no additional cost to the Owner.

PART 2 PRODUCTS

2.1 PIPE

- A. Soil, Waste Vent AND Storm Drain Piping
  - 1. Underground building drainage shall be Polyvinyl Chloride (PVC) pipes and fittings conforming to ASTM D 2665; ASTM F 891; ASTM F 1488 with solvent weld joints conforming to ASTM D 2235.
  - 2. Building sewer shall be Polyvinyl Chloride (PVC) pipes and fittings conforming to ASTM D 2665; ASTM F 891; ASTM F 1488 with solvent weld joints conforming to ASTM D 2235.
  - 3. Soil, waste, and storm drainage piping aboveground shall be PVC or ABS plastic pipes and fittings with solvent welded joints, per ASTM D 2665 or ASTM D 1785
  - 4. Vent shall be Polyvinyl Chloride (PVC) pipes and fittings conforming to ASTM D 3034 and ASTM D 2949 with solvent weld joints conforming to ASTM D 2235.

B. Domestic Water Piping

- 1. All domestic hot and cold water piping shall be hard-drawn copper tube conforming to ASTM B88 with wrought copper fittings.
- 2. Below-grade and below-slab copper piping shall be type "K" with brazed joints; all other copper piping shall be type "L" with joints made up of 95-5 tin-antimony solder.

2.2 PIPE WRAPPING

- A. Wrap all water piping buried in the ground, with "Scotchrap". Wrap all straight runs with 0.020-inch thick tape, spirally applied in half-lap layers. Pre-wrap all joints, valves, and similar irregular surfaces using 0.020-inch thick tape.

2.3 VALVES

- A. Gate valves shall be bronze, solid wedge, inside screw, traveling stem, screw-in-bonnet, 200 lbs. W.O.G., solder ends, "Milwaukee" Figure No. 1153 or approved equal.
- B. Check valves shall be bronze, swing check type, renewable disc, and wrench grip removable caps, soldered ends, 200 lbs. W.O.G., "Milwaukee" Figure No. 508 or approved equal.
- C. Ball valves shall be bronze, two piece body, chrome plated brass ball, regular port, teflon seats and stuffing box ring, blow-out proof stem, lever handle, solder ends.

2.4 PIPE SLEEVES AND ESCUTCHEONS

- A. All pipe sleeves and escutcheons shall be steel pipe and shall have ample clearance for pipe and covering, and shall have chrome plated wall and floor escutcheons over the pipe in

INTERIOR PLUMBING SYSTEM 15400-2

PART 1 GENERAL

1.1 SCOPE OF WORK

- A. Work included: The plumbing system for this Work includes all hot and cold water distribution systems, soil, waste and vent system, plumbing fixtures and trim and all other plumbing items indicated on the Drawings or described in these Specifications, plus all other plumbing items needed for a complete and proper installations. The work also includes plumbing and final connections to other equipment furnished under other sections, including indirect waste lines from fixtures to waste receptors.

- B. Related work described elsewhere: Perform all trenching and backfilling associated with the plumbing installation in strict accordance with the provisions of "Earthwork" Section.

1.2 QUALITY ASSURANCE

- A. Use sufficient journeyman plumbers and competent supervisors in execution of this portion of the Work to ensure proper and adequate installation throughout. In the acceptance or rejection of installed plumbing, no allowance will be made for lack of skill on the part of workmen.

1.3 SUBMITTALS

- A. General: Comply with the provisions of Section 15000.

- B. Product Data: Within 35 calendar days after award of Contract, submit:

- 1. Catalog cuts and other data required to demonstrate compliance with the specified requirements shall be provided for the following:

- a. Plumbing Fixtures & Trims
- b. Pumps
- c. Drains
- d. Cleanouts
- e. Hose Bibb
- f. Valves
- g. Insulation

- C. Operation and Maintenance Manual: Upon completion of this portion of the Work, and as a condition of its acceptance, compile and submit manuals as required under Section 15000 of these Specifications.

1.4 PRODUCT HANDLING

- A. Protection: Use all means necessary to protect the materials of this Section before, during, and after installation and to protect the work and materials of all other trades.

INTERIOR PLUMBING SYSTEM 15400-1



- finished areas.
- 2.4 HANGERS AND SUPPORTS
- A. Hangers and supports shall equal or exceed the quality of the following:
- | Item                  | Manufacturer/Number  |
|-----------------------|--|
| 1. Pipe ring hanger   | Grinnell Fig. 97op, plastic coated for plastic pipes       |
| 2. Clevis Type Hanger | Grinnell Fig. 260, galvanized, for cast iron or steel pipe |

- B. Hanger rods shall be galvanized and shall conform to the following:
- | Pipe Size                   | Rod Diameter |
|-----------------------------|--------------|
| 1. 1/2 inch to 2 inch       | 3/8 inch     |
| 2. 2-1/2 inch to 3-1/2 inch | 1/2 inch     |
| 3. 4 inch to 5 inch         | 5/8 inch     |

- 2.5 WATER HAMMER ARRESTERS
- A. Provide permanently sealed, all stainless steel water hammer arresters properly sized in accordance with Fixture Unit requirement, equaling or exceeding the quality of J.R. Smith Hydrotols.

- 2.6 CLEANOUTS
- A. General: Provide cleanouts equaling or exceeding the quality of the following:
- |                    |  |
|--------------------|--|
| 1. Floor cleanouts | J. R. Smith number 4023.   |
| 2. Yard cleanouts  | J. R. Smith number 4283 with round frame and cover.                                  |
| 3. Wall cleanouts  | "Tee" fittings with J. R. Smith number 4531 or 4551, and chrome plated access cover. |

- B. Finishes: All exposed parts of floor cleanouts shall be scoriated nickel bronze. All grade cleanouts shall have rough scoriated bronze covers.

- 2.7 ISOLATION
- A. Isolate all dissimilar metals with dielectric unions.
- 2.8 DRAINS
- A. The following are products of "J.R. Smith". Equivalent items as manufactured by "Josam", "Wade" or "Zurn" are acceptable:
- Floor and shower drains shall be Figure 2010-A, with 5 inch diameter strainer, cast

- iron body, flashing collar, nickel bronze adjustable strainer head, and caulked outlet.
- Scupper drains shall be Figure 1530, galvanized cast iron body, flashing device and secured grate, threaded outlet.
  - Roof drains shall be Fig. No. 1010 with galvanized cast iron body, low profile rough bronze dome, and flashing clamp, caulked outlet.
  - Overflow drains shall be Fig. No. 1080 with galvanized cast iron body, rough bronze dome, cast iron collar, flashing clamp, caulked outlet.
  - Deck drains shall be Fig. No. 1410 with galvanized cast iron body, polished bronze top, flashing clamp with seepage openings, and caulked outlet.

2.9 PLUMBING FIXTURE

- A. The following fixtures are products of "Sloan" unless indicated otherwise. Equivalent fixtures as manufactured by "American Standard", "Ejler", or "Kohler" are acceptable.
- Water Closet – WC-1: (Flush Valve, Floor-Mounted, Elongated Bowl, 1.28 gpf, for Handicapped)
    - Fixture: Sloan complete HET system with exposed manual Royal closet flushometer and vitreous china water closet. Elongated bowl, floor mounted, 1-1/2" top spud inlet, vitreous china, high efficiency toilet (1.28 gpf), white, "Sloan" WETS 2020.1001-1.28 with "Olsonite" No. 95 open front seat less cover and No. 481310-100 bolt caps.
    - Flush Valve: PERMEX synthetic rubber diaphragm with dual filtered fixed bypass. ADA compliant metal oscillating non-hold open handle non-hold-open handle with triple seal handle packing, fixed metering bypass and no external volume adjustment to ensure water conservation.
  - Water Closet - WC-1: (Flush Valve, Floor-Mounted, Elongated Bowl, 1.28 gpf)
    - Fixture: Sloan complete HET system with exposed manual Royal closet flushometer and vitreous china water closet. Elongated bowl, floor mounted, 1-1/2" top spud inlet, vitreous china, high efficiency toilet (1.28 gpf), white, "Sloan" WETS 2000.1001-1.28 with "Olsonite" No. 95 open front seat less cover and No. 481310-100 bolt caps.
    - Flush Valve: PERMEX synthetic rubber diaphragm with dual filtered fixed bypass, non-hold-open handle, fixed metering bypass and no external volume adjustment to ensure water conservation.

INTERIOR PLUMBING SYSTEM 15400-3

INTERIOR PLUMBING SYSTEM 15400-4

connections, brass shank nuts and coupling nuts, washerless ceramic disc valve cartridge reversible for use with round or lever handles, 6-3/4" spout, pop-up drain, with 1-1/4" tailpiece, polished brass finished.

c. Trap: Catalog No. 4401-014 "P" cast brass trap with tubing drain to wall, 1-1/4" inlet and outlet, ground swivel joint, cleanout plug and escutcheon, chrome finish.

d. Supply: Catalog No. 2303.154 with flexible tube riser, escutcheon, wheel handle, and chrome finish.

e. Under-Sink Protective Enclosure: "Truebro" Lav Shield or approved equal.

6. Kitchen Sink

a. Fixture: "Just" Model No. DL-2233-A-GR, 33" x 22" x 8" deep, double bowl sink, type 304 18 gauge stainless steel, sound deadened, self-rimming.

b. Faucet: "Just" Model No. J-902, deck mounted single lever washerless mixing faucet with escutcheon and hose spray, 8" spout with aerator, spray head mounted on escutcheon, chrome plated cast brass.

c. Supplies: 1/2" angle valves with flexible risers and wall flanges.

d. Trap: 1-1/2" chrome plated cast brass with wall flange.

e. Food Waste Disposer: "Thermador" Model No. 6T722 Royal Deluxe, 1/2" Hp, 115 V, 1 phase, 60 Hz., 1725 Rpm motor, 1-1/2" brass tubing drain.

7. Shower Valve and Fitting

a. Ceramix Model 2000.501 Pressure Balance Shower with ceramic disc valve, hot limit safety stop, check stops, direct sweat inlets, polished chrome finish.

b. Adjustable spray brass shower head with 2.5 gpm flow restrictor.

8. Electric Water Cooler

a. Unit shall be U.L. listed, air-cooled dual height water cooler complying with ARI Standard 1010-84. Capacity shall be 8.0 gph at 90 degrees F, ambient temperature, 80 and 50 degrees F, entering and leaving water temperatures respectively.

b. Receptors, backplate and grille shall be heavy gauge stainless steel with No. 4 satin finish. Bubbler shall be one piece polished chrome-plated, with anti-squirt angle stream. Valves shall be chrome-plated brass with self-closing lever handle valves.

c. Mounting frame manufactured of heavy gauge galvanized steel with predrilled mounting holes.

d. Push actuation mechanism shall be self-closing, polished chrome plated push buttons, with automatic stream height regulator.

INTERIOR PLUMBING SYSTEM

15400-6

3. Urinal – UR:

a. Fixture: Sloan complete HEU system with exposed manual Royal urinal flushometer and vitreous china urinal, "Sloan" WEUS 1000.1001-0.13, wall hung, washdown flushing action, 3/4" I.P.S. top spud inlet, integral flushing rim.

b. Flush Valve: PERMEX synthetic rubber diaphragm with dual-filtered fixed bypass, ADA compliant metal oscillating non-hold-open handle with triple seal handle packing, fixed metering bypass and no external volume adjustment to ensure water conservation.

4. Lavatory – LAV (Countertop):

a. Fixture: 20" x 17", vitreous china, countertop, front overflow, faucet ledge, self-rimming, 16" x 10" x 5-5/8" deep bowl, "Aqualyn" No. 0475.020.

b. Faucet: Two-handle widespread lavatory faucet with conventional spout, "Amarilis/Heritage" Model No. 4801.000.002 with wrist-blade handles Kit No. 372V, cast brass valve bodies with reinforced flexible hose connections, 1/2" male inlet shanks with brass coupling nuts and shank nuts, 1/4 turn washerless ceramic valve cartridges reversible for use with round or lever handles, aerator with 2.5 gpm flow restrictor.

c. Trap: Catalog No. 4401-014 "P" cast brass trap with tubing drain to wall, 1-1/4" inlet and outlet, ground swivel joint, cleanout plug and escutcheon, chrome finish.

d. Supply: Catalog No. 2303.154 with flexible tube riser, escutcheon, wheel handle, and chrome finish.

5. Lavatory - LAV (Handicapped):

a. Fixture: 20-1/2" x 18"-1/4", vitreous china, wall-hung, front overflow, self-draining deck area with contoured back and side splash shields, faucet ledge, 15" x 10" x 6-3/4" deep D-shaped bowl, white, with wall-hanger, "Lucerne" No. 0356.421. Top of front rim mounted 34" from finished floor.

b. Faucet: Single control lavatory faucet Cebaron Model No. 2081.101X all brass body with metal handle, hot limit safety stop, reinforced flexible hose

INTERIOR PLUMBING SYSTEM

15400-5

- e. Refrigeration system shall be hermetic using refrigerant 134a. Compressor shall have an automatic reset overload protection. Air cooled condenser shall be non-ferrous construction. Cooling unit shall be tube type with continuous coil of seamless copper tubing, complete with moisture and vermin proof insulation. Thermostat shall have an adjustable range of 45 to 55 degrees F. Motor shall be 430 watts, 115 volts, single phase, and 60 hertz.
- f. Electric water cooler shall be "Haws" Model HWCD8-2 or approved equal.

2.10 ELECTRIC WATER HEATER

- A. Storage tank shall be .064 inch marine grade 316L stainless steel fully MG welded acid washed passivated and shall require anode rod or preventive maintenance. Water storage tank shall be capable to withstand water temperatures up to 212 F(100 C) without degradation. The storage tank shall be designed to operate in a horizontal orientation, test pressure shall be 300 psi operating pressure shall not exceed 150 psi. Units shall be UL listed.

2.11 HOSE BIBBS

- A. Hose bibbs shall be "Chicago Faucet Co." No. 998 3/4" key operated sill faucet with cast brass body, 3/4" hose connection, vacuum breaker, flanged inlet, and square head shut-off cocks.

2.12 HOT WATER PIPE INSULATION

- A. Hot water pipe insulation shall be 1-1/2 lb. density 1" thick fiberglass pipe insulation with all service jacket vinyl scrim-but-joint strips. Insulation shall be products of "Owens-Corning", "Johns-Manville", or "PPG Industries".

2.13. OTHER MATERIALS

- A. All other materials, not specifically described but required for a complete and proper installation of the work of this Section, shall be new, first quality of their respective kinds, and as selected by the Contractor subject to the approval of the Architect.

PART 3 EXECUTION

3.1 INSPECTION

- A. Examine the areas and conditions under which work of this Section will be performed. Correct conditions detrimental to timely and proper completion of the work. Do not proceed until unsatisfactory conditions are corrected.
- B. Install all piping promptly, capping or plugging all open ends.
- C. Install all piping generally level and plumb, free from traps, and in a manner to conserve for other work.
- D. Provide uniform pitch of at least 1/4 inch per foot for all horizontal waste and soil piping

INTERIOR PLUMBING SYSTEM 15400-7

- E. Pitch all vents for proper drainage. Install vent piping with each bend 45 degrees minimum from the horizontal wherever structural conditions will permit.

- F. Conceal all piping unless otherwise shown on the Drawings.

- G. Inspect each piece of pipe, couplings, fittings, and equipment for defects and obstructions. Promptly remove all defective material from the site.

- H. Maintain fixtures to the following heights above finished floor (unless otherwise indicated on architectural drawings):

Lavatory:

- 1. Standard 31 inches to top of basin rim
- 2. Accessible (ADA) 34 inches to top of basin rim

- I. Maintain utilities connections to the following heights above finished floor (unless otherwise indicated on architectural drawings):

	<u>HotWater</u>	<u>ColdWater</u>	<u>Waste</u>
1. Lavatory	20-3/4"	20-3/4"	19-1/2"
2. Kitchen Sink	20-3/4"	20-3/4"	19-1/2"
3. Water Closet			
a. Flush Tank Floor Mounted Regular	----	26-1/2"	----
4. Shower	32"	32"	----

3.2 FIXTURE ROUGH-IN SCHEDULE

- A. Rough-in fixture piping connections in accordance with following table of minimum sizes for particular fixtures:

INTERIOR PLUMBING SYSTEM 15400-8

	<u>HotWater</u>	<u>ColdWater</u>	<u>Waste</u>	<u>Vent</u>
1. Lavatory	1/2"	1/2"	1-1/2"	1-1/4"
2. Service Sink	1/2"	1/2"	2"	1-1/2"
3. Kitchen Sinks	1/2"	1/2"	1-1/2"	1-1/4"
4. Water Closet	-	1"	4"	2"

### 3.3 JOINTS AND CONNECTIONS

- A. Preparation: Properly ream all cut pipes. Cut all threads straight and true, apply best quality teflon tape to male pipe threads, but not to inside the fittings. Use graphite on all cleanout plugs.

### 3.4 HANGERS AND SUPPORTS

- A. Spacing: Do not exceed the following spacing, on centers:

<u>Type of pipe</u>	<u>Spacing</u>
1. PVC	Five feet
2. Copper or steel, 1-1/2 inch and smaller	Six feet
3. Copper or steel, two inches and larger	Ten feet

- B. Supporting: Use a separate hanger for each branch. Support vertical risers at the floor with extension pipe clamps approved by the Architect.
- C. Secure all branch take-off to fixture immediately before fixture faucet inlet connections, conceal support or clamp in wall.

### 3.5 EQUIPMENT

- A. Install all equipment in accordance with manufacturer's published instructions and recommendations.

### 3.6 CLOSING IN UNINSPECTED WORK

- A. Do not cover up or enclose work until it has been properly and completely inspected and approved. Should any of the work be covered up or enclosed prior to all required inspections and approvals, uncover the work as required and, after it has been completely inspected and approved, make all repairs and replacements with such materials and workmanship as are necessary to the approval of the Architect, and at no additional cost to the Owner.

### 3.7 TESTING

- A. General: Furnish all test pumps, gages, equipment, and personnel required, and test as necessary to demonstrate the integrity of the finished installation to the approval of all

pertinent authorities and the Architect.

- B. Soil, Waste and Vent Piping: Unless otherwise directed, plug all openings and fill with water to a height not less than 10 feet above horizontal pipes. Allow to stand one hour or longer as required. Redo leaking joints as directed and then re-test.

- C. Water Lines: Test and make tight at 150 psi water gage. Retain for four hours; repair all leaking joints and then re-test.

### 3.8 DISINFECTION OF DOMESTIC WATER PIPING SYSTEM

- A. Prior to connecting to existing piping, flush clean and disinfect new piping.
- B. Ensure PH of water to be treated is between 7.4 and 7.6 by adding alkali (caustic soda or soda ash) or acid (hydrochloric).
- C. Inject disinfectant, free chlorine in liquid, powder, tablet or gas form, throughout system to obtain 50 to 80 mg/L residual.
- D. Bleed water from outlets to ensure distribution and test for disinfectant residual at minimum 15 percent of outlets.
- E. Maintain disinfectant in system for 24 hours.
- F. If final disinfectant residual tests less than 50 mg/L, repeat treatment.
- G. Flush disinfectant from system until residual disinfectant equals that of incoming water or not more than 0.5 mg/l nor less than 0.2 mg/l.
- H. Take samples no sooner than 24 hours after flushing, from 10 percent of outlets and from water entry, and analyze in accordance with AWWA C601.
- I. Bacteriological Analysis of Water: After the completion of disinfection procedure, including the final flushing as described heretofore, the Contractor shall obtain water samples from this system for bacteriological analysis. Requirements for satisfactory disinfection of water supply are that bacteriological analysis indicates that water samples are negative for coliform organisms and that total plate count is less than 100 bacteria per cubic centimeter. Submit certified laboratory analysis to Division of Environmental Quality (DEQ) for evaluation.

- J. Final Approval: If bacteriological analysis does not satisfy above requirements, then disinfection procedure shall be repeated until these requirements are met.

- K. Discharging Used Water: Water used in the disinfection process must be disposed of to a ponding basin, percolation trench, holding tank, water truck tank or to any other location and method acceptable to CNMI's Division of Environmental Quality (DEQ).

- L. Certification: Deliver a "Certificate of Completion of Disinfection" to the Architect.

### 3.9 LEAD ANALYSIS

- A. Lead concentration of water in the new water line must be analyzed and submit test results to Division of Environmental Quality (DEQ).

INTERIOR PLUMBING SYSTEM

15400-9

CENTRAL POLICE PRECINCT

INTERIOR PLUMBING SYSTEM

15400-10

SECTION 16050

BASIC ELECTRICAL MATERIALS AND METHODS

PART 1 GENERAL

1.1 RELATED DOCUMENTS: This Section supplements all sections of Division 16, and shall apply to all phases of work specified, shown on the drawings, and required to provide all electrical systems complete and operable for the project. The work required under the Division is not limited to the work shown on the electrical drawings. Refer to site, architectural, structural and mechanical drawings, coordinate all such work to attain fully operational systems throughout the project. The intent of this specification is to provide a complete and operating electrical system in accordance with all Contract Documents.

1.2 WORK INCLUDED: Provide all labor, materials, services and skilled supervision necessary for the construction, erection, installation, connection, testing, and adjustment of all circuits and electrical equipment required by the Contract Documents, complete in all respects and ready for use.

1.3 SUPERVISION OF WORK

A. Electrical work shall be under the full supervision of a professional electrical engineer or a master electrician registered to practice in the Territory of Guam. Within 30 calendar days after the Contractor has received the Owner's Notice to Proceed, submit a certification from the Professional Engineer or master electrician stating that the work will be done under his full supervision. At the conclusion of the work, prior to final inspection, submit certification that the work was done in accordance with electrical construction documents and the installation complies with the latest edition of the National Electrical Code.

B. Fire alarm system manufacturer's Technical Representative shall supervise, approve and certify installation and testing of Fire Alarm System devices and wiring.

1.4 COORDINATION OF WORK

A. Plan all work so that it proceeds with a minimum of interference with other trades. Coordinate all openings required for equipment and conduit required for work of other trades. Provide all special frames, sleeves and anchor bolts as required. Coordinate electrical work with the mechanical installation.

B. Work lines and established heights shall be in accordance with architectural drawings. Verify all dimensions shown and establish all elevations and detailed dimensions not shown.

C. Lay out and coordinate all work well in advance to avoid conflicts or interference with other work in progress so that in the event of interference, the electrical layout may be altered to suit the conditions, prior to the installation of any work, and without additional cost to the Owner. Conflicts arising from lack of coordination shall be the contractor's responsibility.

D. Maintain all code required clearance around electrical equipment. Unless specifically noted otherwise, establish the exact location of electrical equipment based on the actual dimensions of equipment furnished.

1.5 COOPERATION WITH OTHER TRADES

A. Cooperate and coordinate all work of Division 16 with that of other trades; afford reasonable opportunity for the execution of their work. Properly connect and coordinate this work with

BASIC ELECTRICAL MATERIALS AND METHODS

16050-1

the work of other trades at such time and in such a manner as not to delay or interfere with their work.

B. Examine the drawings and specifications for the general and mechanical work, and the work of other trades. Coordinate this work accordingly.

C. Promptly report to the Contracting Officer any delay or difficulties encountered in the installation of this work which might prevent prompt and proper installation, or make it unsuitable to connect with or receive the work of others. Failure to report shall constitute an acceptance of the work of other trades as being fit and proper for the execution of this work.

1.6 CODES, PERMITS AND FEES

A. Perform work in accordance with the National Electrical Code, applicable building ordinances, and other applicable codes, hereinafter referred to as the "Code". Where the Contract Documents exceed minimum requirements, the most stringent shall apply unless variance is approved.

B. Comply with all requirements for permits, licenses, fees, and codes. Obtain all required permits, licenses, inspections, and pay all fees required to perform the work described in the Contract Documents.

C. Comply with all requirements of the applicable utility authorities serving the project. Make all arrangements with the utility authorities for proper coordination of the work.

1.7 MATERIALS AND EQUIPMENT FURNISHED BY OTHERS: The electrical work includes the installation or connection of certain materials and equipment furnished by others. Verify installation details. Foundations for apparatus and equipment will be furnished by others unless otherwise noted or detailed.

1.8 CONTRACT DRAWINGS: The Contract Drawings are shown in part diagrammatic, and intend to convey the scope of work, indicating the intended general arrangement of equipment, conduit and outlets. Follow the drawings in laying out the work and verify spaces for the installation of materials and equipment based on actual dimensions of equipment furnished. Wherever a question exists regarding the intended location of outlets or equipment, circuiting, etc., obtain instructions from the Contracting Officer before proceeding with the work.

1.9 EQUIPMENT OR FIXTURES: Equipment or fixtures shall be connected to provide circuit continuity in accordance with applicable codes whether or not each piece of conductor, conduit, or protective device is shown between such items of equipment or fixtures, and the point of circuit origin.

1.10 NEW EQUIPMENT AND MATERIAL:

A. Unless otherwise specified, equipment and materials of the same type of classification, and used for the same purpose shall be products of the same manufacturer. Use only new and unweathered material.

B. Furnish products listed and classified by Underwriter's Laboratories, Inc.

1.11 APPLICABLE DOCUMENTS: Design, manufacture, testing and method of installation of all apparatus and materials furnished under Division 16 of the specifications shall conform to the latest publications or standard rules of the following:

- Institute of Electrical and Electronic Engineers  
(Formerly American Institute of Electrical Engineers) - IEEE
- National Electrical Manufacturers' Association - NEMA

BASIC ELECTRICAL MATERIALS AND METHODS 16050-2

- Underwriters Laboratories, Inc. - UL National Fire Protection Association - NFPA American Society for Testing and Materials - ASTM American National Standards Institute - ANSI National Electrical Code - NEC
- National Electrical Safety Code - NESC
- Uniform Fire Code - UFC
- International Building Code - IBC
- Insulated Power Cable Engineers Association - IPCEA
- Americans with Disabilities Act Guidelines - ADAG
- American Institute of Steel Construction - AISC
- Department of Public Works Standards, Government of Guam - DPW
- Guam Fire Department Standards, Government of Guam - GFD
- Guam Power Authority Standards, Government of Guam - GPA
- GTA Standards - GTA
- Guam Environmental Protection Agency - GEPA

1.12 EXECUTION OF THE WORK

A. Install equipment and materials in neat and workmanlike manner and align, level and adjust for proper operation. Install equipment so that all parts are easily accessible for inspection, operation, maintenance, and repair.

B. Where damage, marring or disfigurement has occurred, replace or refinish the damaged surfaces as directed, and to the satisfaction of the Contracting Officer.

C. Provide the design, fabrication, and erection of all supplementary structural framing required for attachment of hangers or other devices supporting electrical equipment. Submit design/shop drawing to the Contracting Officer for approval.

D. Outlet Location:

1. Position of outlets: Center all outlets with regard to panelling, furring and trim. Symmetrically arrange outlets in the room. Satisfactorily correct outlets improperly located or installed. Repair or replace damaged finishes. Set outlets plumb and extend to the finished surface of the wall, ceiling or floor without projecting beyond same.

2. Install all receptacles, switches, and outlets shown on the wood trim, cases or office fixtures symmetrically, and where necessary, set the long dimension of the plate horizontal, or ganged in tandem.

1.13 SPECIAL CONSIDERATION

A. Cutting, Patching and Piercing: Obtain written permission from the Contracting Officer before cutting or piercing structural members.

1. Use craftsmen skilled in their respective trades for cutting, fitting, repairing, patching of plaster and finishing of materials including carpentry work, metal work or concrete work required for by Division 16. Do not weaken walls, partitions or floor by cutting. Holes required to be cut in floors must be drilled or cored without breaking or spalling around the holes. Do all necessary patching and/or refinishing as instructed by the Contracting Officer.

2. Sleeves through floors and walls to be galvanized rigid steel flush with walls, ceiling or finished floors; size to accommodate the raceway.

BASIC ELECTRICAL MATERIALS AND METHODS 16050-3

3. Use care in piercing waterproofing. After the part piercing waterproofing has been set in place, seal opening and make absolutely watertight.
4. Provide baked white enamel painted spring-clipped escutcheon plates where exposed pipe passes through walls, floors, or ceilings. Cover sleeves and entire opening made for the pipe with escutcheon plates. Field applied paint finish shall match color of surrounding finish. Seal all conduit openings through floor slabs, masonry walls, and continuous partitions to make air and watertight. Tightly caulk space between conduit and abutting materials with fiberglass insulation and nonflammable sealant.
- B. Seal equipment or components exposed to the weather and make watertight and insect-proof. Protect equipment outlets and conduit openings with temporary plugs or caps at all times that work is not in progress.
- C. Equipment Access: Locate starters, switches, receptacles, and pull boxes to allow easy equipment identification: identify each piece of equipment including disconnect switches and motor starters, with plastic laminate nameplates, black face with white core letters, having proper and complete identification. Clearly identify on the equipment served, and spell out the full name of the equipment, such as "Air Handling Unit AHU-1" and "Hot Water Cir. Pump P-1". Do not use abbreviated plan references such as "AHU-1" or "P-1".
- D. Equipment Access: Locate starters, switches, receptacles, and pull boxes to allow easy access for operation, repair and maintenance, and if concealed, provide access doors.
- E. Equipment Bases: Provide equipment bases on all floor-mounted equipment furnished under this Contract.
- F. Protection of apparatus, materials and equipment: Take all necessary precautions to properly protect all apparatus, fixtures, appliances, material, equipment and installations from damage of any kind. The Contracting Officer may reject any particular piece or pieces of material, apparatus, or equipment which has scratches, dents or otherwise damaged.
- G. Operation and Maintenance Manuals: During the time of the Contract and before final acceptance of the electrical installation, submit to the Contracting Officer three copies of all descriptive literature, maintenance recommendations from the equipment manufacturer, data of initial operation, wiring diagrams and parts list of each item of electrical equipment installed under the Contract; submit all manufacturer's guarantees and warranties. Submittal shall include: switchboards, motor control centers, generators, and fire alarm system.
1. Refer to Division 1 for additional requirements.
- H. Painting Preparation: Prepare all exposed fittings, boxes, supports and panelboards for painting; remove traces of oil, grease and dirt. Employ all necessary precautionary methods to prevent scratching or defacing of all electrical apparatus and devices.
- I. Painting: Exposed conduit, boxes installed after room has been painted, shall be painted to match room finish by this contractor.
1. Corrosion Control: All corrosive metal surfaces, conduits/fittings, pipelines and structures shall be provided with corrosion inhibiting primer before installation. Appropriate surface preparation shall be made before application of primer.
- J. Rust Prevention: Provide hot dip galvanized finish for all ferrous materials. In addition, outdoor installations shall be field painted with two coats of enamel paint.

BASIC ELECTRICAL MATERIALS 16050-4  
AND METHODS

- K. Tests: Provide all tests as outlined hereinafter, and other tests necessary to establish the adequacy, quality, safety, completed status, and suitable operation of each system. Tests shall be conducted in the presence of the Contracting Officer.
1. Ground Rod Test: Immediately after installation, test driven grounds with direct reading single-test megger, utilizing the AC fall-of-potential method and two reference electrodes. Orient the ground to be tested and two reference electrodes in a straight line spaced 50 feet apart. Drive the reference electrodes 5 feet deep. Disconnect the ground rod to be tested from other ground system at the time of testing. Ground resistance for the electrical service shall be 25 ohms or less. Ground resistance for communication system shall meet manufacturer's minimum requirements. Submit the results, date of test, and soil conditions, to the Contracting Officer in writing, immediately after testing.
2. System voltage at each panelboard measure voltage between phases; phase to neutral; phase to ground; and neutral to ground. Measurements shall be conducted during unloaded condition and repeated during loaded condition. Adjust system volume to within  $\pm 3\%$  of nominal voltage.
3. Insulation resistance of conductors.
- L. Seismic Consideration: Installation shall meet Seismic Zone 4 requirements.
- M. Windload Consideration: Installation exposed to outdoors shall be designed to withstand 170 MPH wind speed IBC-2009 Exposure C and ASCE7-05.
- 1.14 QUALITY ASSURANCE
- A. Use adequate numbers of skilled workmen who are thoroughly trained and experienced in the necessary crafts and who are completely familiar with the specified requirements and the methods needed for proper performance of the work of this Division.
- B. Without additional cost to the Owner, provide such other labor and materials as are required to complete the work of this Division in accordance with the requirements of governmental agencies having jurisdiction, regardless of whether such materials and associated labor are called for elsewhere in these Contract Documents.
- 1.15 PROTECTIVE DEVICES COORDINATION STUDIES
- Contractor shall provide the services of a qualified relay coordination engineer to perform a complete relay coordination study of the entire electrical distribution system. The studies shall include a complete single-line diagram of the power system covered by this specification, time-current characteristic curves, current transformer ratios, and relay device numbers and settings; fully coordinated composite time-current characteristic curves including recommended ratings and settings of all protective devices in tabulated form. Provide associated calculations to demonstrate that the power system protection will be selectively coordinated by the use of devices or equipment supplied. These studies shall be certified by a registered Professional Electrical Engineer. Final copy of the report shall be incorporated in the electrical O&M Manual. Perform testing and calibration of power relays by a certified relay technician.
- 1.16 ELECTRICAL SERVICE
- A. Electrical service to the building is as indicated on the drawings.
- BASIC ELECTRICAL MATERIALS 16050-5  
AND METHODS

- B. Make all necessary arrangements with the serving utilities, and pay all costs and fees, assessed to the project by the serving utilities. All work shall be in accordance with serving utilities standards and subject to their approval. Coordinate the installation of service entrance equipment with GPA prior to start of construction.
- C. Application for power service must be submitted to GPA eight months before service connection to allow for timely delivery of transformers.

1.17 PRODUCT HANDLING: Comply with pertinent provisions of Division 1.

1.18 WARRANTY: Provide one year warranty on all labor and materials.

1.19 AS-BUILT DRAWINGS

- A. The Contractor shall maintain at the site one copy of all Drawings, Specifications, Addenda, approved Shop Drawings, Change Orders, and other modifications, in good order, and marked to record all changes made during construction. These shall be made available to the Contracting Officer.
- B. At the conclusion of the work, the Contractor will be furnished by the Contracting Officer, at the Contractor's expense, a set of reproducible made from original contract plans. The Contractor shall then incorporate all changes made, as recorded, into the set of reproducible in a clear, legible and reproducible manner. All feeders, main alarm and communication lines, service entrance, and stub-outs shall be dimensionally located within the building structure. As a condition for acceptance of work, "as-built" reproducible shall be signed by Contractor attesting that all changes have been incorporated, dated and delivered to the Contracting Officer.

1.20 SPARE PARTS AND MAINTENANCE PRODUCTS

- A. Provide spare parts, maintenance, and extra Products in quantities specified in individual specification sections.
- B. Deliver to Project site and place in location as directed; obtain receipt prior to final payment.

END OF SECTION

BASIC ELECTRICAL MATERIALS AND METHODS 16050-6



**IFB# GHURA-11-16-2021-AMP's 1, 3 & 4**

**Specification  
for the**

**Renovation of Eight (8) Public Housing Units  
at AMP's 1, 3 & 4**

**OWNER  
Guam Housing and Urban Renewal Authority**

**BY: \_\_\_\_\_  
Ray S. Topasna, EXECUTIVE DIRECTOR**

**Contractor: \_\_\_\_\_**

**By: \_\_\_\_\_  
Signature and Title**

**Date: \_\_\_\_\_**

**END OF SPECIFICATION**